



**Software for Opto-Mechanical Modeling**

---

**RayViz™ for SOLIDWORKS®  
User's Manual  
Release 2025**

**Revised 3-April-2025**

Lambda Research Corporation  
515 Groton Road  
Westford, MA 01886

[support@lambdares.com](mailto:support@lambdares.com)



## **COPYRIGHT AND TRADEMARK ACKNOWLEDGMENTS**

### **COPYRIGHT**

The RayViz for SOLIDWORKS software and manual are Copyright © 2025 by Lambda Research Corporation. All rights reserved.

This software is provided with either a single user license or a network license. A single user license may only be used by one user and on one computer at a time. A network license may be used by one or more users, up to the number purchased for the network license, on any computer connected to the license server via the network.

The user's manual contains proprietary information. This information as well as the rest of the manual may not be copied in whole or in part, or reproduced by any means, or transmitted in any form without the prior written consent of Lambda Research Corporation.

### **TRADEMARKS**

TracePro and OSLO are registered trademarks of Lambda Research Corporation.

RayViz is a trademark of Lambda Research Corporation.

The following are trademarks or registered trademarks of Kubotek Corporation in the USA and/or other countries: KUBOTEK® KUBOTEK3D™ KEYCREATOR® KUBOTEK KOSMOS KCM

ACIS is a registered trademark of Spatial Corporation.

Adobe and Acrobat are trademarks of Adobe Systems Incorporated.

CodeMeter® is a registered trademark of WIBU-SYSTEMS AG.

SOLIDWORKS is a registered trademark of Dessault Systemes SolidWorks Corporation.

Windows and Microsoft are either registered trademarks or trademarks of Microsoft Corporation in the United States and/or other countries.

All other names and products are trademarks of their respective owners.

## **LICENSE AGREEMENT**

The purchaser of this product is granted a license to use the product subject to the following restrictions and limitations.

1. The license is to the original purchaser only, and is not transferable without written permission of Lambda Research Corporation.
2. With a single-user license, only one copy of the software may be used on a single computer at a time. The software may be transferred for use on another computer, but the software may not be used simultaneously on more than one computer unless additional licenses are purchased for each multiple simultaneous use.
3. A network license may be used by one or more users, up to the number purchased for the network license, on any computer connected to the license server via the network. The license may be transferred to a different server computer by moving the license key and installing the license server software on the new server computer.

4. The original purchaser may make backup copies of the original software for his own use only, subject to the use limitations of this license agreement.
5. The original purchaser may not engage in, or permit third parties to engage in, any of the following:
  - a. Providing the use of the software in a computer service business, network, or time-sharing use to users who are not individually licensed by Lambda Research Corporation.
  - b. Making alterations or copies of any kind in the software except as specifically permitted above.
  - c. Attempting to disassemble, decompile, or reverse engineer the software in any way.
  - d. Attempting to defeat the hardware key or license manager software.
6. You may not use or otherwise export or re-export the licensed product except as authorized by United States law and the laws of the jurisdiction in which the licensed product was obtained. In particular, but without limitation, the licensed product may not be exported or re-exported (a) into any U.S. embargoed countries or (b) to anyone on the U.S. Treasury Department's list of Specially Designated Nationals or the U.S. Department of Commerce Denied Person's List or Entity List. By using the licensed product, you represent and warrant that you are not located in any such country or on any such list. You also agree that you will not use these products for any purposes prohibited by United States law, including, without limitation, the development, design, manufacture or production of missiles, or of nuclear, chemical, or biological weapons.

## **WARRANTY**

Although Lambda Research Corporation has made every effort to ensure that the software is technically accurate, Lambda Research makes no representations or warranties of any kind whatsoever, directly or indirectly, with respect to the contents hereof or the software described herein. Lambda Research shall not be liable for errors contained herein or with the software described herein for any incidental or consequential damages caused by, or in connection with, the furnishing, performance, use of, or any inability to use this product.

With respect to the physical CD-ROM, hardware key, and documentation enclosed herein, Lambda Research warrants the same to be free of defects in materials and workmanship for a period of thirty days from the date of purchase. Lambda Research will replace the defective CD-ROM, key, or documentation within this warranty period upon receipt of the defective product. Lambda Research reserves the right to make changes to the software or documentation without obligation to notify any person of such revision or change.

# Table of Contents

COPYRIGHT AND TRADEMARK ACKNOWLEDGMENTS.....	iii
LICENSE AGREEMENT .....	iii
WARRANTY.....	iv
Table of Contents.....	1
Chapter 1 – Introduction .....	4
Chapter 2 - Installation.....	5
First Use of RayViz .....	5
New Property Database .....	5
Changing Database .....	5
Chapter 3 – Graphical user interface.....	6
System Tree.....	7
RayViz CommandManager toolbar.....	9
RayViz Menu.....	11
Saving TracePro Models.....	13
Chapter 4 - Applying Properties .....	14
Loading an Optical Property .....	14
Limitations in Pre-Defined Property Data .....	14
Applying Property Data .....	14
The properties accessible in RayViz for SOLIDWORKS .....	15
Applicable Properties: .....	15
Object Applicable Properties: .....	15
Surface Applicable Properties: .....	16
Applying Properties Using SOLIDWORKS Selection .....	16
Object Applicable Properties.....	18
Material .....	18

---

Class and User Data.....	19
Mueller Matrix.....	19
Mueller Matrix Options.....	20
Gradient Index.....	22
Bulk Scattering.....	23
Fluorescence.....	23
Temperature.....	25
Importance Sampling.....	26
Raytrace Flag.....	28
Surface Applicable Properties.....	29
Surface.....	29
Surface Source Properties.....	30
Emission Type.....	32
Prescription.....	34
RepTile Surfaces.....	34
Temperature.....	36
Temperature Distribution.....	37
Importance Sampling.....	37
Exit Surface.....	38
Diffraction.....	38
Chapter 5 – Ray Tracing.....	40
Introduction to Ray Tracing.....	40
Why Monte Carlo Ray Tracing?.....	40
Surface Sources.....	40
Standard (Forward) Raytrace.....	40
Raytrace Options.....	41
Chapter 6 - Workflows.....	42

How to work with RayViz for SOLIDWORKS.....	42
Workflow: Working exclusively with RayViz in SOLIDWORKS (CAD).....	43
Workflow: SOLIDWORKS (CAD) to TracePro (Non-Sequential Ray Tracing) .....	44
Workflow: TracePro (Non-Sequential Ray Tracing) to SOLIDWORKS (CAD) .....	45
Workflow: Working exclusively with TracePro (Non-Sequential Ray Tracing).....	46
Best Practices: .....	47

# Chapter 1 – Introduction

RayViz for SOLIDWORKS is an Add-in tool designed to allow SOLIDWORKS users the capability to apply optical and source property data directly to their SOLIDWORKS models and to raytrace these models using Monte-Carlo ray tracing. This makes it possible to add optical properties to your SOLIDWORKS file to maintain the design intent contained in the model and save optical and source properties with that model. Designers can also export SOLIDWORKS-made models ready for ray tracing and optical analysis in TracePro.

This document is intended for users that want to do simple ray tracing in SOLIDWORKS, and for users who want to export a fully defined optical or illumination system for further design and simulation in TracePro. RayViz for SOLIDWORKS seamlessly incorporates optical property assignment and model navigation features from TracePro into the SOLIDWORKS environment. The following chapters detail the installation process, the user interface, ray tracing and the property database handling along with a detailed description of each surface and material property available for SOLIDWORKS models.

- Chapter 2 describes the installation process as well as the licensing information for this product.
- Chapter 3 covers the user interface adaptation to operate RayViz features within SOLIDWORKS, which includes an overview of the RayViz toolbar, menus and system tree.
- Chapter 4 details the creation of an optical part in SOLIDWORKS, including applying object and surface properties to parts.
- Chapter 5 describes how rays are traced through the model by defining ray starting points using surface sources. How the rays are launched into the model, and which raytrace parameters are invoked to control how the ray propagates through the optical model.
- Chapter 6 discusses the various methods to use RayViz to do optical analysis in SOLIDWORKS and how RayViz can benefit designers through its use.



## Chapter 2 - Installation

Version 2025 of RayViz requires SOLIDWORKS 2014 or later release. An equal or later release of TracePro is required if you are saving TracePro Models for ray tracing and analysis in TracePro. SOLIDWORKS must be installed on the same computer that RayViz is being installed on.

The installation instructions can be found in the installation guide RayViz\_InstallationGuide.pdf that is available on the Lambda Research Website or on the installation CD you may have received.

### First Use of RayViz

RayViz is a licensed software program and requires one license per simultaneous user. See the section on Licensing in RayViz\_InstallationGuide.pdf for licensing options and troubleshooting licenses.

### New Property Database

Upon initial launch of RayViz, the following message will appear:

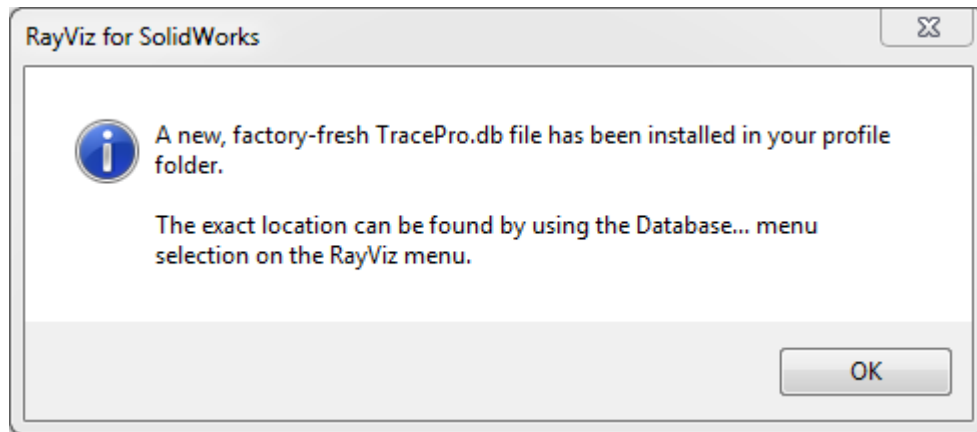

Figure 2.1 RayViz property database message box

Click OK to acknowledge that a new Properties Database file has been copied to your user profile. RayViz is now ready to run.

The default database that is included with RayViz is the same one that is shipped with TracePro 2025.

**Note:** You can have different copies of the RayViz and TracePro property databases, but you should make sure that the same one is used by both RayViz and TracePro for any particular model.

### Changing Database

In the SOLIDWORKS menu bar, a new RayViz menu is installed, providing an option to change the property database. These options are described in Chapter 3.

## Chapter 3 – Graphical user interface

Upon starting SOLIDWORKS with RayViz installed, you will notice that a **RayViz** menu has been added after the SOLIDWORKS **Tools** menu item. After opening a part or assembly you will also notice the RayViz tab in the CommandManager and the small RayViz tab in the Feature Manager. Figure 3.1 shows these aspects of RayViz within the SOLIDWORKS environment. It shows the RayViz CommandManager Toolbar, RayViz menu, RayViz feature manager tab, and the RayViz System Tree. Clicking on the RayViz tab shows the RayViz System Tree, replacing the usual SOLIDWORKS Feature manager. The tree contains the individual Objects (SOLIDWORKS bodies) that comprise the current model. Each body consists of a set of surfaces. The System Tree is explained in more detail in the next section.

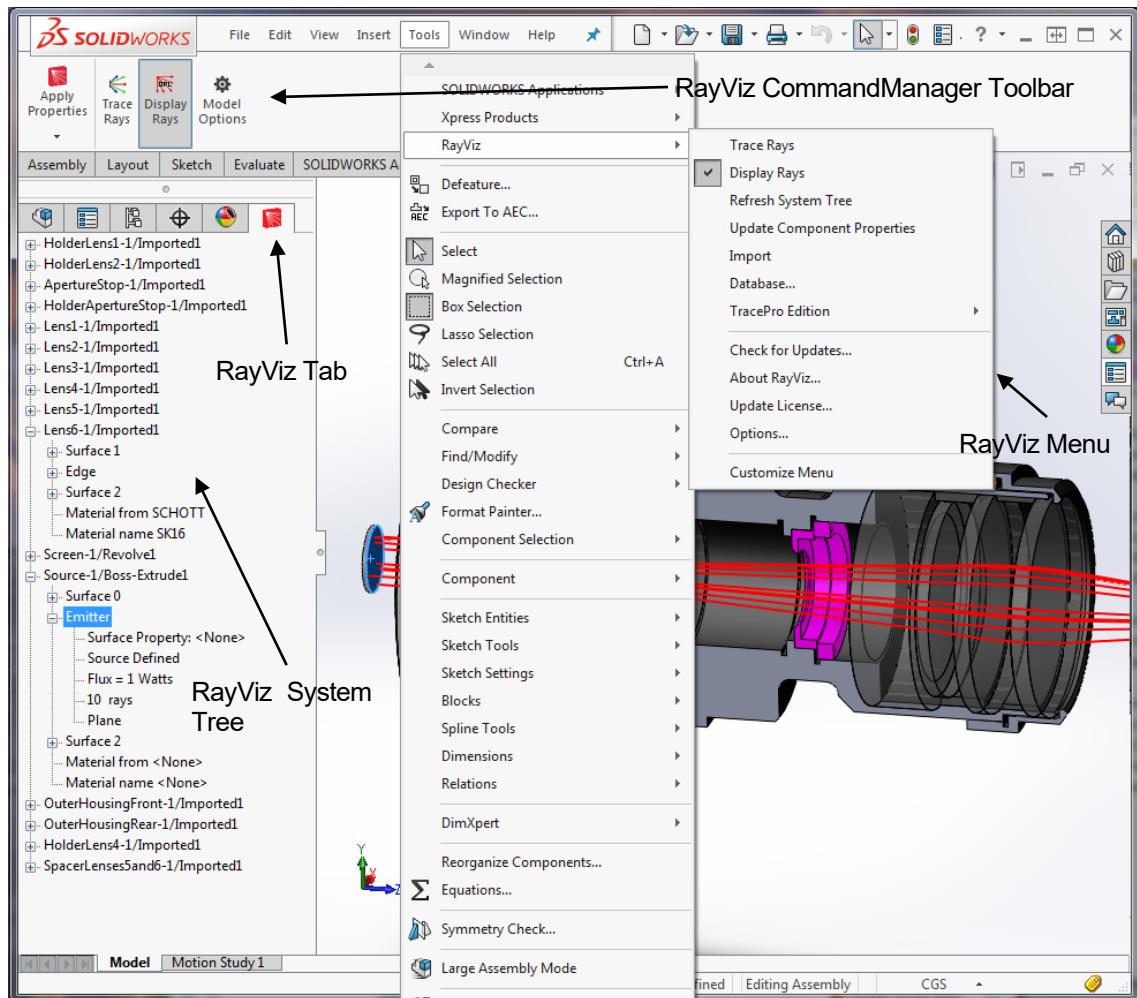
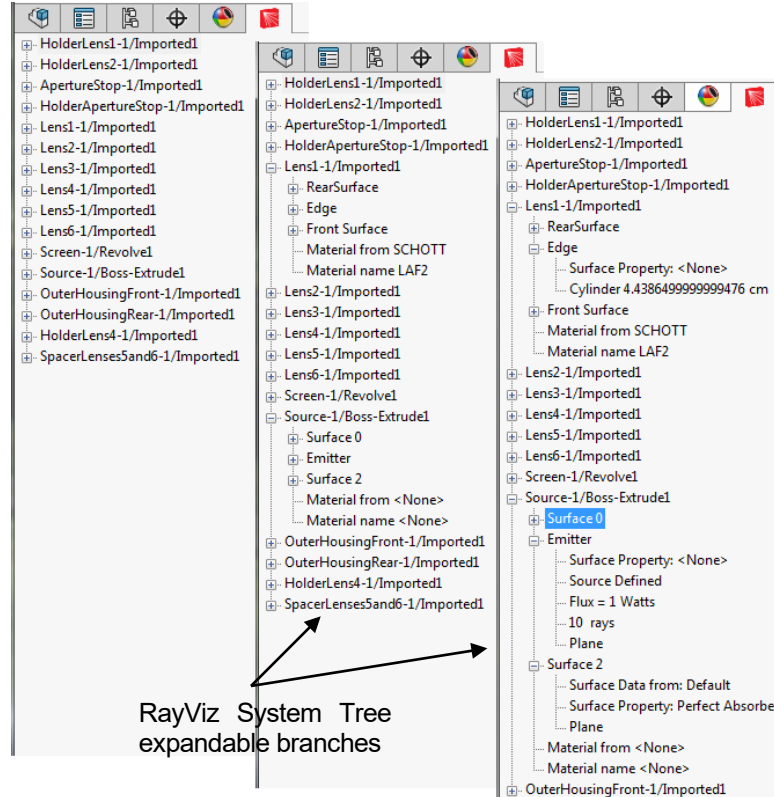

Figure 3.1 Layout of RayViz for SOLIDWORKS environment

## System Tree

Just like in TracePro, the system tree lists the Objects and Surfaces that comprise the model as well as the properties that have been applied. By default, the tree lists the Objects in the part or assembly (see the leftmost image in Figure 3.2). When in Part Design Mode, the default object names correspond to SOLIDWORKS body names. When in Assembly design Mode, the default object names contain the component instance names and the final body name. Figure 3.2 shows the names in an assembly where the component “Source-1” with body name “Boss-Extrude1 is expanded and “Surface 0” is selected.



**Figure 3.2** Three depictions of the System Tree under the RayViz tab within SOLIDWORKS. The leftmost image depicts the default view of the tree at the highest level, while the other two images show the effects of successive clicks on the expand icons (“+”).

Clicking on the plus sign (“+”) to the left of any item in the tree expands it to show its features, surfaces, and properties (see the center and rightmost images of Figure 3.2). Once expanded, clicking on the minus sign (“-”) to the left of an item collapses its view. You can also collapse and expand by right clicking on an object and selecting one of the up to four options in the bottom of the provided list: Collapse All, Collapse Branch, Expand All, and Expand Branch (see, for example, Figure 3.3(b)). Finally, as in TracePro, you can navigate, with closing and expanding options using the arrows on the keyboard.

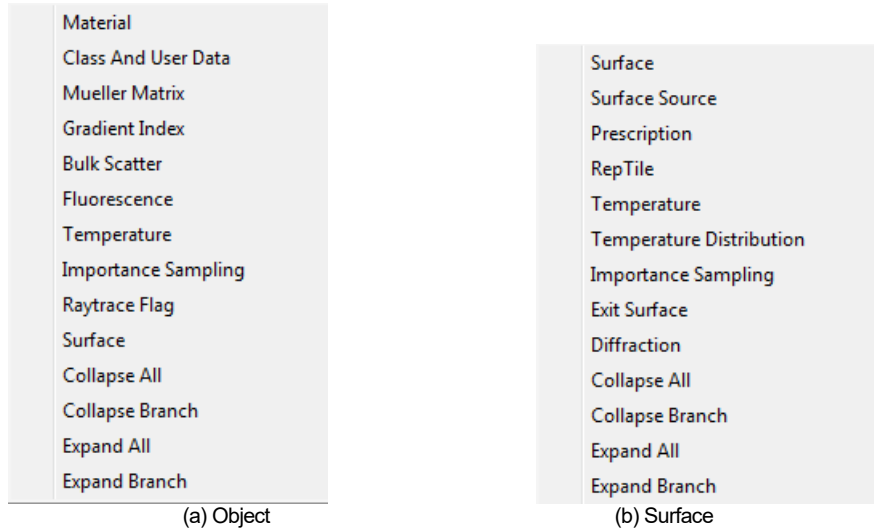

**Figure 3.3** The resultant drop-down menu when you right click on an item in the RayViz System Tree

Right clicking on any item opens up a drop down menu featuring different optical properties relevant to the item that was selected (see Figure 3.3). Objects (bodies in a parts or assembly) offer the Object Applicable Properties (e.g., Material, see Figure 3.3(a)) and Surfaces offer the Surface Applicable Properties (e.g., Surface Source, see Figure 3.3(b)). Both sets feature the Expand All or Expand Branch and Collapse All or Collapse Branch options.

When selecting an item in the property menus, the SOLIDWORKS Property Manager is displayed for the particular property. This acts as the TracePro Property dialog window. If desired, you can use the SOLIDWORKS functionality to split the Feature Manager panel. This is shown in Figure 3.4. In this case, the Property Manager is displayed in the lower feature manager view. This allows you to keep track of the selected items while you apply or modify properties to them.

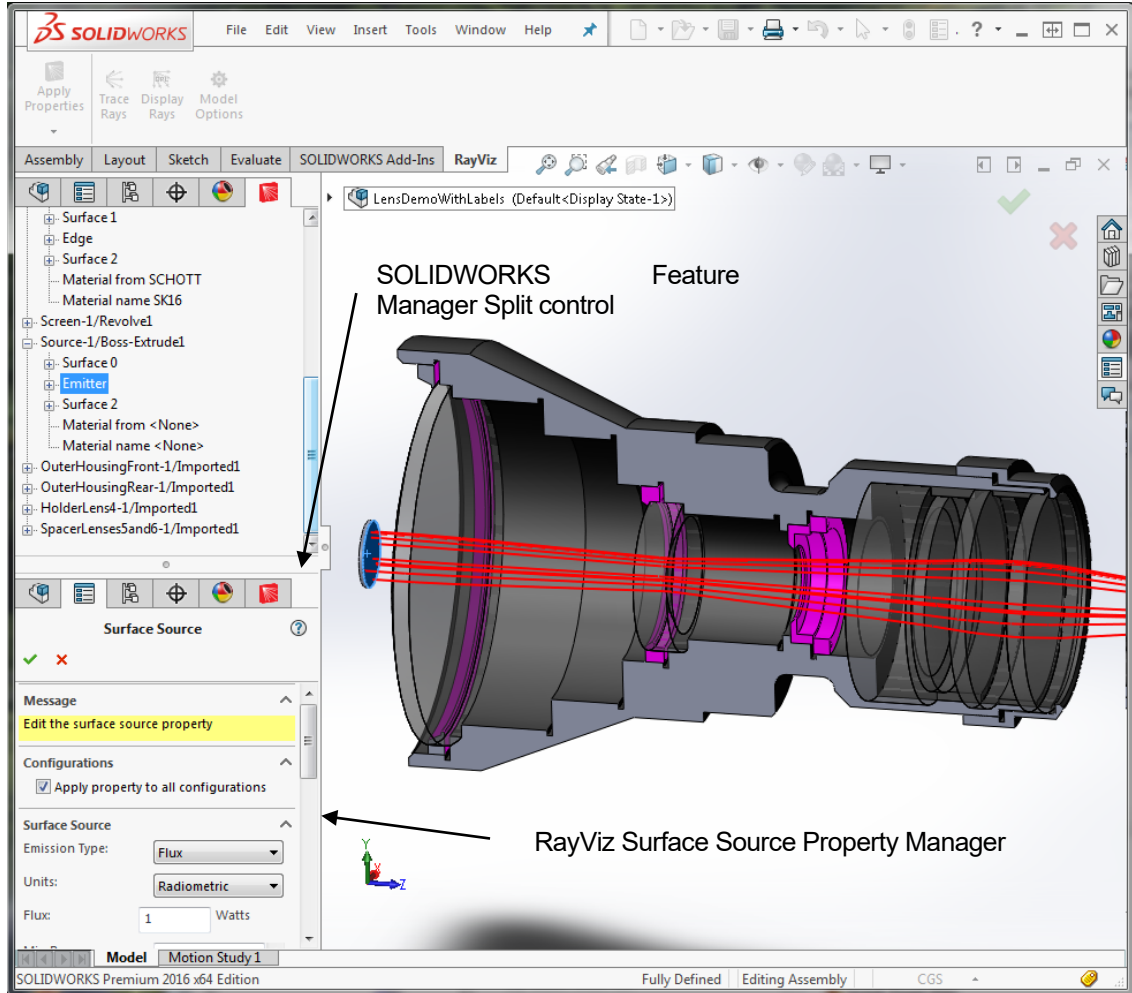





Figure 3.4 Split Feature Manager Panel with Temperature Property Manager

## RayViz CommandManager toolbar

The RayViz tab on the SOLIDWORKS CommandManager contains frequently used RayViz commands for the SOLIDWORKS document type that is open.

- **Apply Properties** : This option displays a SOLIDWORKS Flyout toolbar which is similar to a dropdown menu with a list of properties that can be applied. See Chapter 4 - Applying Properties.
- **Trace Rays** : This option initiates ray tracing in RayViz. For a detailed description see the discussion of **Standard (Forward) Raytrace** in Chapter 5 – Ray Tracing.

- **Display Rays** : This option allows you to control if rays are displayed. In RayViz, rays are displayed by default after a raytrace is finished or canceled. Rays are displayed when the button is in the pressed state. If many rays have been traced with many splits or “branches,” it can take several minutes for RayViz to finish displaying the rays.
- **Options** : This selection allows you to customize the operation of RayViz as shown in Figure 3.5. With the dialog that is displayed you can change the default settings.

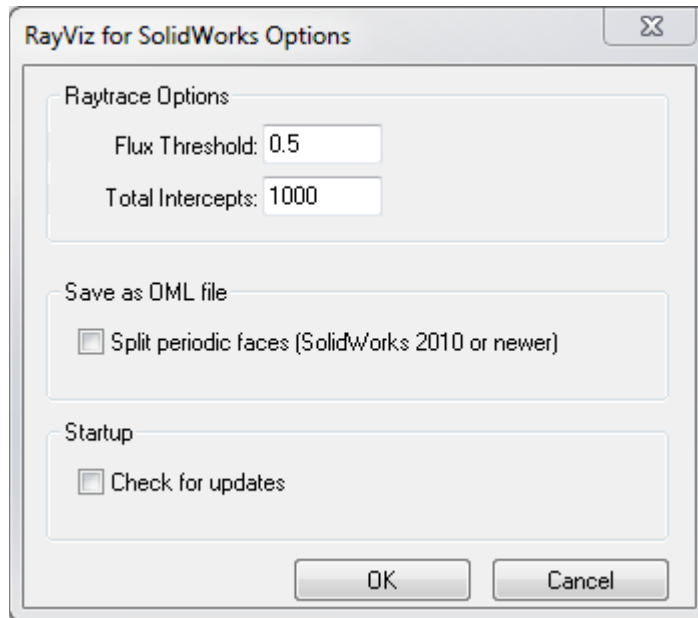

Figure 3.5 RayViz for SOLIDWORKS Options dialog.

The RayTrace Options group contains options for setting the **Flux Threshold** and **Total Intercepts**. See the discussion on **Raytrace Options** in “Chapter 5 – Ray Tracing” for a description on how these settings are used during ray tracing.

The **Split periodic faces** option added for SOLIDWORKS 2010 allows you to control whether periodic surfaces like cylinders or spheres are split while saving your SOLIDWORKS model as an OML file. Periodic faces are always split with SOLIDWORKS 2009.

The default setting for this option is to not split faces. In general, this is the desired setting because a single surface is used for property definition and ray trace results. This setting also matches the behavior in both TracePro and SOLIDWORKS.

If **Check for updates** is checked, RayViz will query the Lambda Research web site for a newer release of RayViz when SOLIDWORKS is started or when RayViz is loaded using the SOLIDWORKS Tools|Add Ins dialog. If your support subscription entitles you to this newer release, RayViz will invite you to let it download and install the release automatically. The detailed description can be found in the installation guide [RayViz\\_InstallationGuide.pdf](#) that is available on the Lambda Research Website or on the installation CD you may have received.

## RayViz Menu

The RayViz menu is accessible from the SOLIDWORKS Tools menu. In SOLIDWORKS 2014 and earlier versions, this will be on the SOLIDWORKS main menu. The RayViz menu has the following selections (see Figure 3.6):

- **Trace Rays:** This option initiates ray tracing in RayViz. For a detailed description see the discussion of Standard (Forward) Raytrace in Chapter 5 – Ray Tracing.
- **Display Rays:** This option allows you to control if rays are displayed. In RayViz, rays are displayed by default after a raytrace is finished or canceled. Rays are displayed when the check mark is displayed to the left of the option. If many rays have been traced with many splits or “branches,” it can take several minutes for RayViz to finish displaying the rays.
- **Refresh System Tree:** While this normally is updated by itself, this option is a sure way of regenerating the System Tree after a rebuild in SOLIDWORKS.
- **Update Component Properties:** This option will update properties in the active SOLIDWORKS assembly to reflect the current values from the components. NOTE: Properties and names added or changed in the assembly will be replaced with the current values from the components.
- **Import:** This option reads in a TracePro Property Import File, which is of type txt, so that new properties can be included in your Property Database.
- **Database...:** This option allows you to select the default RayViz Property Database for assigning optical properties.
- **TracePro Edition:** Allows the user to select which edition of TracePro for which the model is being built: Expert, Standard, or LC. The check indicates which edition has been selected. The default is TracePro LC because RayViz ray tracing supports the same properties that can be added in TracePro LC.

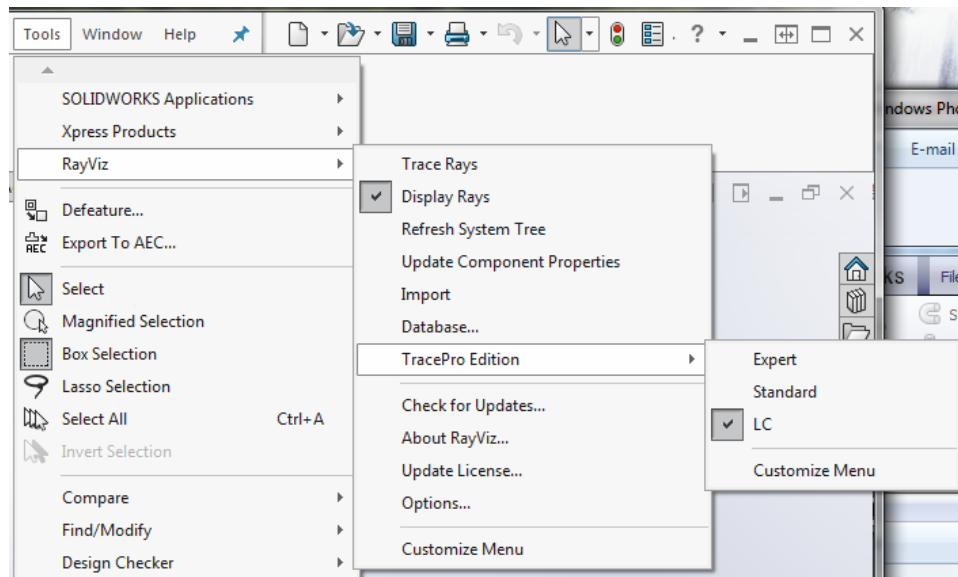

**Figure 3.6** The options within the RayViz menu and the TracePro Edition submenu.

- **Check For Updates:** This command will check the Lambda Research website for new releases of RayViz. The detailed description can be found in the installation guide RayViz\_InstallationGuide.pdf that is available on the Lambda Research Website or on the installation CD you may have received.
- **About RayViz...:** This selection shows the about box for RayViz as shown in Figure 3.7. Of importance in this dialog is the Version, License Information and Build Numbers, which you can refer to when asking Technical Support or update questions. Select **OK** when done.

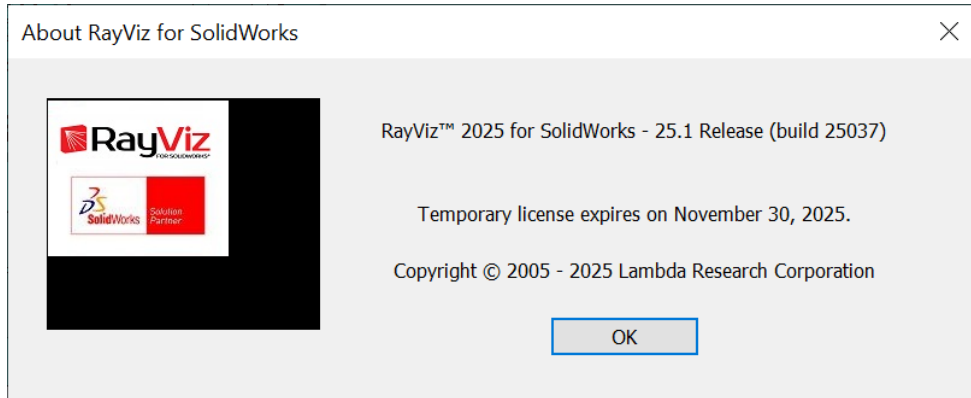

Figure 3.7 About RayViz for SOLIDWORKS dialog.

- **License...:** This will bring up RayViz License Information dialog. The detailed description can be found in the installation guide RayViz\_InstallationGuide.pdf that is available on the Lambda Research Website or on the installation CD you may have received.
- **Options...:** See the discussion on Options in **RayViz CommandManager** on page 9.
- **Customize Menu:** This feature within the main menu and submenus allows you to show or hide all the previous items in the drop down menu. Check or uncheck the boxes to enable or disable them.



## Saving TracePro Models

Another Key feature of RayViz for SOLIDWORKS is its capacity to save files as \*.oml files, TracePro's native file format. To do this, under **File>>Save As...** select **TracePro Files (\*.oml)** in the **Save as type** field. All other features are the same as they are in SOLIDWORKS.

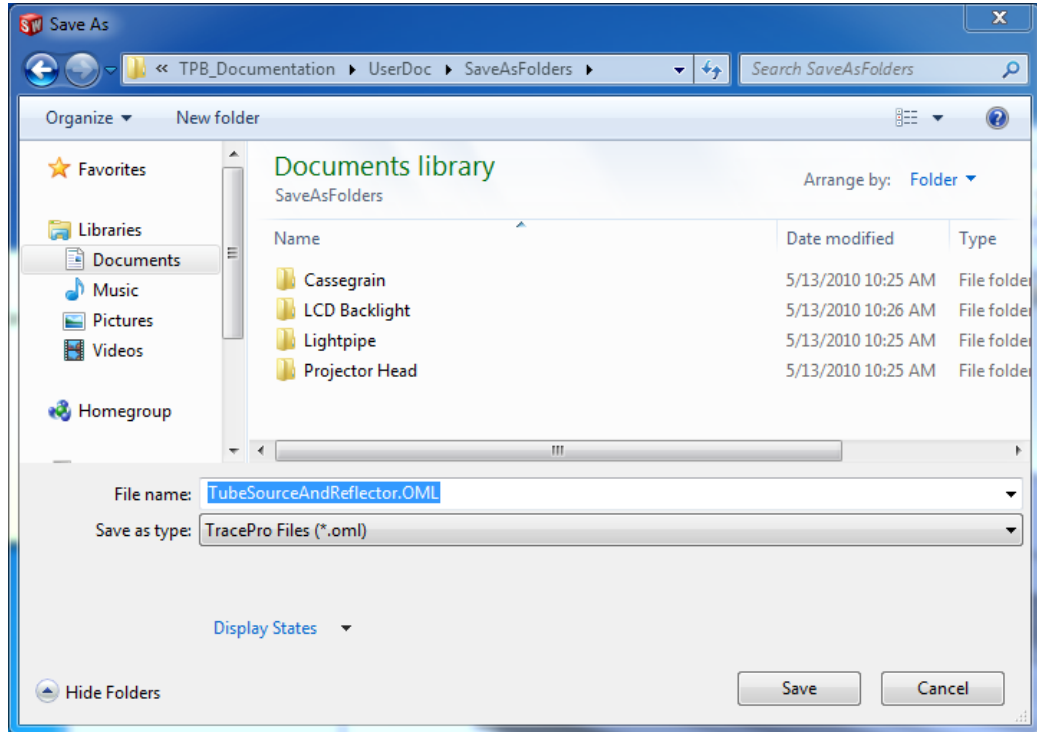

Figure 3.8 Save As... dialog showing a part being saved in the TracePro oml format.

## Chapter 4 - Applying Properties

### Loading an Optical Property

After the geometry has been created in SOLIDWORKS, optical properties are assigned, which determines how rays interact with the model and how the geometry is displayed in the TracePro Model Window. TracePro has extensive capabilities to define or allow changes to these properties, but this capability is limited with RayViz. Certain tables, scattering equations and other parameters can only be customized in TracePro. If custom properties are needed, they should be programmed in TracePro, and then saved and added to the TracePro database. They can then be applied in SOLIDWORKS. To add this property to the TracePro property database, use a common database to TracePro and RayViz, otherwise use the **Import** option from the **RayViz** menu. This and other limitations are discussed in the following sections.

**Note:** Depending on the edition of TracePro you are using, you may not be able to ray trace all properties. Certain properties can only be used in TracePro LC, Standard, or Expert. Each property in this document is listed with the appropriate TracePro editions. By setting the TracePro Edition, you will be prevented from adding properties that are not supported in that Edition. You will be warned during ray tracing if properties were added that are not supported by your TracePro Edition. RayViz supports the same properties as TracePro LC.

### Limitations in Pre-Defined Property Data

Much of the property data supplied with RayViz is derived from data sheets, Measurements, and published data. In some cases the data is very complete, as is the case with optical glass data from manufacturers like Schott, Ohara, and Hoya. In other cases the data is only given for a small range of values, which is the case for the metal properties from manufacturers like Sacall. For example, aluminum suppliers declare specular reflection and diffuse reflection in accordance with DIN 5036, which is a method of measurement that uses an integrating sphere. This is insufficient to describe the BSDF distribution function necessary to simulate scatter in RayViz or TracePro. It is recommended that each user verify that the data is appropriate for their needs and that measured data be obtained directly from the material vendor or a third party measurement service. This is particularly important for scatter data and optical coatings.

### Applying Property Data

Which properties are needed to model a specific problem? To answer this question, it is useful to think of the properties in terms of Physical Properties versus Ray Trace Properties. Physical Properties translate into the hardware that is built when the model or design is completed, such as Material and Surface properties. Ray Trace Properties are not physical attributes of the final hardware, but are applied to utilize features available in RayViz that assist in making the ray trace more efficient while maintaining accuracy. Importance Sampling and Exit Surfaces are examples of Ray Trace Properties.

It is not necessary to apply any of these properties to a given model, and the method for applying them is the same for all property types. The only distinction is between properties that are applied to Objects versus those applied to Surfaces. This chapter concentrates on property application.

**Note:** Properties must exist in the Property Database to be used. A number of properties are predefined for your use, but you may define new ones within TracePro (See Chapter 4 of the TracePro User's Manual). RepTile™ Properties must be defined prior to use and are stored in the Property Database (See "RepTile Surfaces" in Chapter 4 of the TracePro User's Manual).

## The properties accessible in RayViz for SOLIDWORKS

### Applicable Properties:

As per Figure 3.3 there are (a) Object and (b) Surface properties. The options shown in this figure are described here in more detail. The steps required in SOLIDWORKS are presented here. First, we consider the Object properties (see Figure 3.3(a)) followed by Surface properties (see Figure 3.3(b)).

### Object Applicable Properties:

- **Material:** Allows for the application of materials to an object. This process includes the Catalog and Name of the Material property.
- **Class and User Data:** Provides resources that the TracePro macro language can use. A brief discussion is provided below, but consult the *TracePro User's Manual* for more details.
- **Mueller Matrix:** Allows the user to specify the polarization characteristics of the material through the Mueller Matrix. Examples include linear polarizers and retarders. Defined polarization characteristics can be selected by the user, or custom polarization characteristics can be entered.
- **Gradient Index:** For materials that have an index of refraction variation as function of position. For example, radial and linear gradient index profiles can be entered. There is a large database of gradient index materials provided with the software.
- **Bulk Scattering:** This property allows for scattering within the volume of an object. A number of biomedical volume scattering profiles are supplied with the software.
- **Fluorescence:** This property is the generation of light rays within a material, but the wavelength is away from that of the standard ray trace wavelength(s). These "fluorescence" rays are created by absorption in the medium of interest. Associated with this property are the concentration, its expected efficiency, and the absorption loss.
- **Temperature:** Useful factor for temperature dependent properties, such as the **Material** and **Surface** Properties.
- **Importance Sampling:** In order to speed up ray traces, importance sampling directs scattered or emitted rays to a desire target. These targets include circular and rectangular shapes in the ray-trace space.
- **Ray Trace Flag:** This option allows the user to remove or add an object from subsequent ray traces.
- **Surface:** This option allows you to easily add the same property to all surfaces of an Object. See the Surface property in the next section for a complete description.

### Surface Applicable Properties:

- **Surface:** The optical characteristics of a surface including Bare, in which case the material index plays a large role in the ray trace results. This process includes the Catalog and Name of the Surface property.
- **Surface Source:** Allows you to define a Surface Source for subsequent ray traces. The source can be set as Flux, Irradiance, Blackbody, or Graybody.
- **Prescription:** Needed for Auto Importance Sampling and optical scatter intercept limits. A brief discussion is provided below, but consult the *TracePro User's Manual* for more details.
- **RepTile:** Allows you to define microstructure that is applied to planar surfaces in a model. This option allows you to apply these surfaces to multiple planar surfaces of an object.
- **Temperature:** Specifies the temperature for a given surface within the model.
- **Temperature Distribution:** A file assigned to a surface provides the temperature distribution across the surface. This temperature distribution, for example, can affect the Surface property or Thin Film Stack.
- **Importance Sampling:** In order to speed up ray traces, importance sampling directs scattered or emitted rays to a desired target. These targets include circular and rectangular shapes in the ray-trace space.
- **Exit Surface:** A simulation ray-trace model in TracePro allows for timelier and less data-intensive calculations in comparison to the Analysis ray-trace mode. Surfaces within the TracePro model that are designated to be exit surfaces have their incident and absorbed ray data retained for analysis.
- **Diffraction:** Allows you to designate if edges of the surface will cause diffraction of incident rays.

**Note:** Assemblies in SOLIDWORKS are files containing more than one individual part. Each SOLIDWORKS part may contain multiple bodies. Within RayViz, each body is an object that can have its properties set independently. This classification carries over to the RayViz System Tree where each body is defined as a separate object. The Drawing mode does not support RayViz for SOLIDWORKS.

**Note:** You may select a property by right clicking on an object or surface within the System Tree, and then choosing the appropriate item from the drop-down list. Additionally, you can double click on the property within the System Tree, e.g., "Surface Property" as provided in Figure 3.1.

### Applying Properties Using SOLIDWORKS Selection

In addition to the System Tree properties may be applied to faces or bodies using SOLIDWORKS selection. The Apply Properties command in the RayViz command manager toolbar can be used to choose the property to be applied or edited. The properties Property Manager page will contain a SOLIDWORKS selection box control that sets appropriate selection filters for the property. These

work like other selection boxes in the SOLIDWORKS user interface. Just select the geometry for the property in the graphics window

Object and Surface Applicable properties can also be applied directly using the SOLIDWORKS selection and the SOLIDWORKS popup menus. Properties can be applied to Surfaces by right clicking on the desired face in the graphics window. The SOLIDWORKS popup menus for Objects and Surfaces are shown in Figure 4.1.

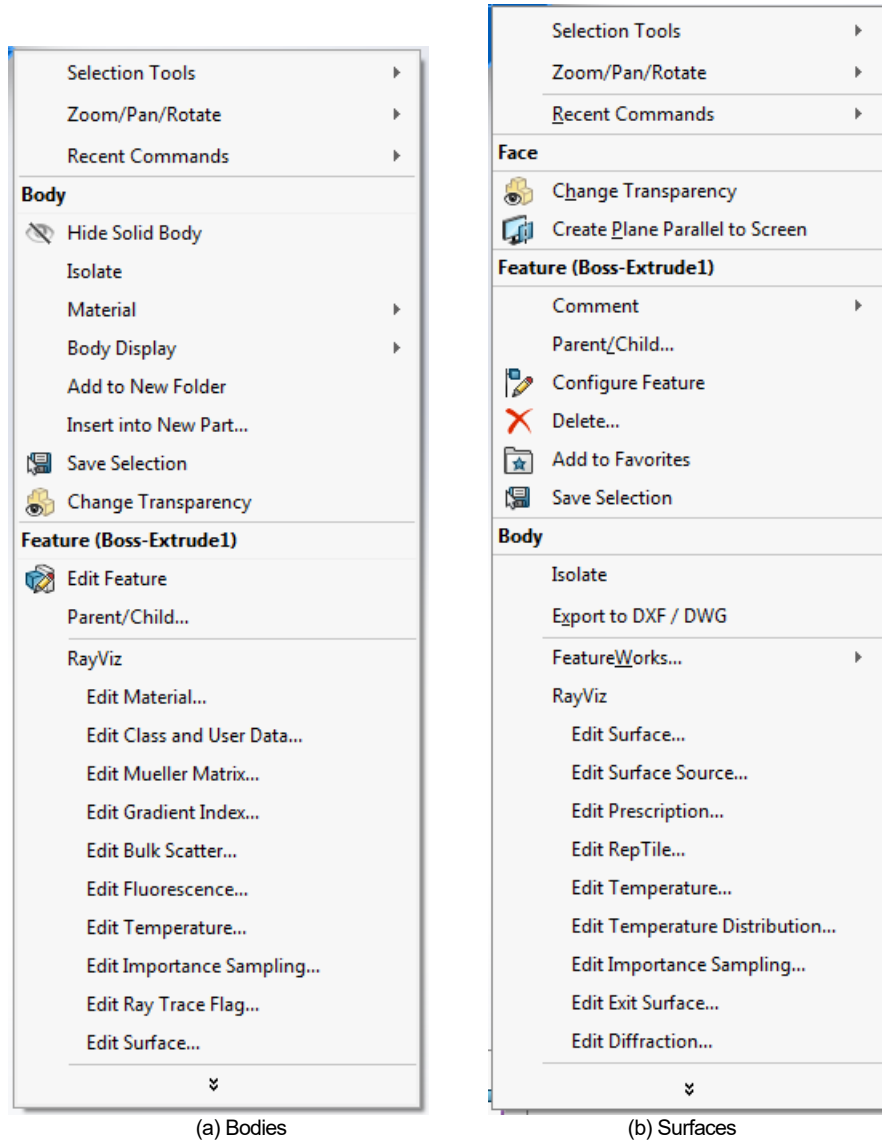

**Figure 4.1** SOLIDWORKS context sensitive popup menus for Objects and Surfaces

SOLIDWORKS Bodies (RayViz Objects) can't be selected by default in the graphics window. You must use a selection filter set to bodies. With this filter set, you can right-click on the body and apply properties by choosing the RayViz property type on the SOLIDWORKS menu. Bodies can also be selected in the Feature Manager Tree view if the Bodies folder is displayed and expanded.

**Note:** By default the Bodies folder is not displayed in the Feature Manager Tree if the number of Bodies in a Part is less than two. You can tell SOLIDWORKS to always display the folder in the System Options for the Feature Manager.

## Object Applicable Properties

**Material** **LC** **Standard** **Expert**

The Material Property is used to specify the index of refraction and the bulk absorption of an object. A database exists containing predefined materials. You can choose among them while working in RayViz. To modify or add user-defined materials you must use the Material Property editor within TracePro. See “Material Properties” on page 4.4 of the *TracePro User's Manual*.

To apply Material to an object in your model:

- Select an object in your model. Right-click on the object in the System Tree, Feature Manager or Graphics Window. The same property can be applied to multiple objects by selecting more than one object and then right-clicking on one of the selected objects.
- Select the **Material** option on the drop-down menu.
- The **Message** area indicates what you are supposed to do, while the Configurations group controls whether the property is applied to the current configuration or to all configurations.
- In the **Material** Property Manager, select a **Catalog** using the drop-down catalog list and select the **Name** of the desired material using the drop-down name list.
- In **Index and Absorptance** you can view partial data for the selected property: Wavelength, Index of Refraction, Absorption and Transmission coefficients relative to depth.
- Check that the property's characteristics are the correct ones.
- Click the **green checkmark** to apply the changes.
- Check that the new property is clearly visible in the System Tree.

For Birefringent Material Properties (available only in TracePro Expert) you must also enter the Crystal Axis and the data type you wish to use. The orientation of the crystal axis is maintained relative to the object as the object is moved and rotated. A separate dialog box appears below the regular **Index and Absorptance** dialog box in which the axis data can be entered.

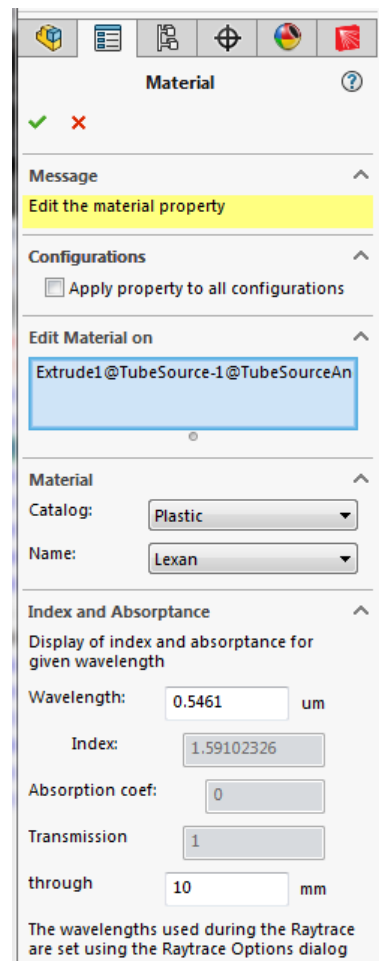

**Figure 4.2** Material Property Manager

## Class and User Data Standard Expert

The Class Data feature lets a user apply a string attribute and numeric data to one or more parts (objects). The **Class Name** is displayed in various outputs and is accessible within TracePro from the macro language. See the online Macro Reference for further information on specific macro commands.

To apply Class and User Data to one or more bodies (objects):

- Select an object in your model. Right-click on the object in the System Tree, Feature Manager or Graphics Window. The same property can be applied to multiple objects by selecting more than one object and then right-clicking on one of the selected objects.
- Select the **Class and User Data** option on the drop-down menu.
- The **Message** area indicates what you are supposed to do, while the Configurations group controls whether the property is applied to the current configuration or to all configurations.
- In the **Class and User Data** Property Manager, enter a **Class Name** in the first field and input the **User Data** in the following **Value** Fields. You can also delete the input values by clicking on the **Delete Values** button.
- Check that the property's characteristics are the correct ones.
- Click the **green checkmark** to apply the changes.
- Check that the new property is clearly visible in the System Tree.

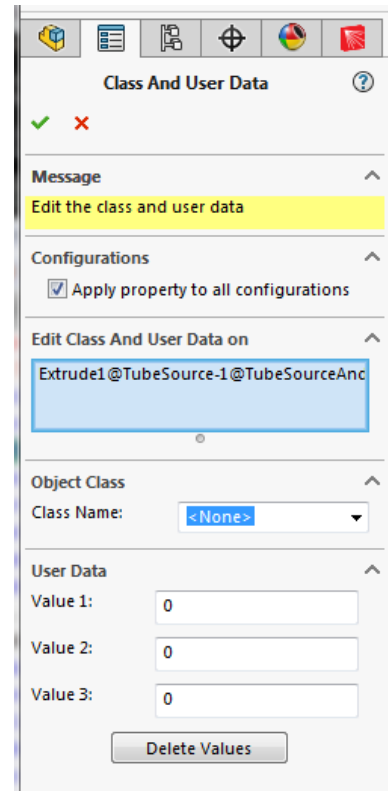

**Figure 4.3** Class and User Data Property Manager

User data is also available to apply numeric data to one or more objects. This data may be used during macro operations in TracePro to store values used during the course of ray tracing. The Property Report and System Tree display the applied Class and User data. The Online Macro Reference provides detailed descriptions of the macro commands used with Class and User data.

## Mueller Matrix Standard Expert

You can create and apply polarization components to a SOLIDWORKS part by specifying its Mueller matrix. Once the file is open in TracePro, it uses the Stokes vector-Mueller matrix method (Mueller calculus) for modeling polarized light.

To apply a Mueller Matrix to an object:

- Select an object in your model. Right-click on the object in the System Tree, Feature Manager or Graphics Window. The same property can be applied to multiple objects by selecting more than one object and then right-clicking on one of the selected objects.
- Select the **Mueller Matrix** option on the drop-down menu.
- The **Message** area indicates what you are supposed to do, while the Configurations group controls whether the property is applied to the current configuration or to all configurations.
- In the **Mueller Matrix** Property Manager, select the **Component** (e.g., polarizer, retarder, or custom) you want to apply to the object. If you want to build a custom Matrix, please refer to the options section below. The matrix components are not shown since the list is extensive – it is under the second **Mueller Matrix** area, which is collapsed.
- Check the **Faraday Type** box if necessary for your application.
- Set the **Propagation** and **Up Directions**, which are described in more detail below.
- Check that the property's characteristics are the correct ones.
- Click the **green checkmark** to apply the changes.
- Check that the new property is clearly visible in the System Tree.

## Mueller Matrix Options

### Component:

You can select one of several predefined types of polarizing components:

- Transmission Axis Orientation in degrees for Linear Polarizers.
- Handedness Choice of Left or Right for Circular Polarizers and Circular Halfwave Retarders.
- Fast Axis to X Axis Orientation in degrees for Linear Quarterwave Retarders and Linear Halfwave Retarders.

### Mueller Matrix:

**Mueller Matrix** displays the terms of the 4 x 4 Mueller Matrix for the current polarizing component. This matrix is also used when the **Custom** component is selected to define the polarizing element. These matrix terms must be normalized. Mueller matrices must be defined with care – it is quite possible to

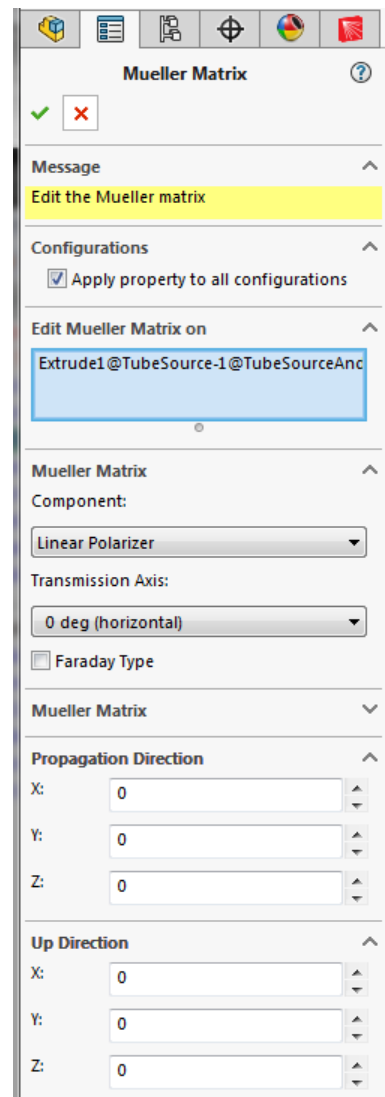

**Figure 4.4** Mueller Matrix Property Manager



create a Mueller matrix that is impossible, i.e., one that creates a resulting Stokes vector that is not physically possible.

When a ray traverses a polarizing object, the Stokes vector of the ray is transformed to the coordinate system of the Mueller matrix and then multiplied by the Mueller matrix to determine the new polarization state of the ray. Any flux that is absorbed by the Mueller Matrix is recorded as the ray enters the object. That is, the incident flux on the surface as the ray leaves the object is lower by the amount absorbed as determined by the Mueller Matrix. This process is similar to that of bulk absorption. A Mueller matrix is a 4 x 4 matrix and a Stokes vector is a column vector of length 4. Therefore, multiplying a Stokes vector by a Mueller matrix produces a new Stokes vector. In this way a Stokes vector can be propagated through an optical system. For example, a Mueller Matrix that does nothing is the unit matrix.

### **Directions:**

If you specify a Mueller Matrix, you must also specify its orientation. Do this by specifying the **Up Direction** vector and the **Propagation Direction** vector at the bottom of the dialog box. Orientation vectors are specified in global coordinates. The propagation direction vector specifies the direction in which light is traveling when the Mueller Matrix has the specified effect. Global propagation and up directions of the object are automatically updated if the object is rotated or moved.

## Gradient Index Standard Expert

Gradient Index (GRIN) Properties apply to materials with an inhomogeneous index of refraction. Examples are glass in which the index changes from center to edge, or optical fiber that also refracts light differently from center to edge. The gradient index is coupled to the object's material property to vary the index of refraction along a parametric profile.

GRADIUM, one of the types in the **Grin Property Name** drop-down box, must be treated differently. Unlike others, GRADIUM includes material property data and does not require association with a material property. In cases like this one, **DO NOT** apply a material property to an object that has GRADIUM applied. For all other Gradient Index properties, you must apply a material property as the base index.

To apply Gradient Index to an object:

- Apply a Material property on the part (see the Material Property section in this chapter). The Material selected is shown in the Current Material drop-down Box in the **Gradient Index** Property Manager (bottom of Figure 4.5).
- Select an object in your model. Right-click on the object in the System Tree, Feature Manager or Graphics Window. The same property can be applied to multiple objects by selecting more than one object and then right-clicking on one of the selected objects.
- Select the **Gradient Index** option on the drop-down menu.
- The **Message** area indicates what you are supposed to do, while the Configurations group controls whether the property is applied to the current configuration or to all configurations.
- In the **Gradient Index** Property Manager, select the **Grin Catalog** you want to build your property from and then choose the **Grin Property Name** from that catalog.
- The profile is applied to the object along with an **Origin** (shown above), **Normal Direction** (collapsed), and **Up Direction** (collapsed). The Up Vector is included to define lateral symmetries. Once these vectors are applied, the origin and direction vectors are updated if you move or rotate the object.
- Check that the property's characteristics are the correct ones.

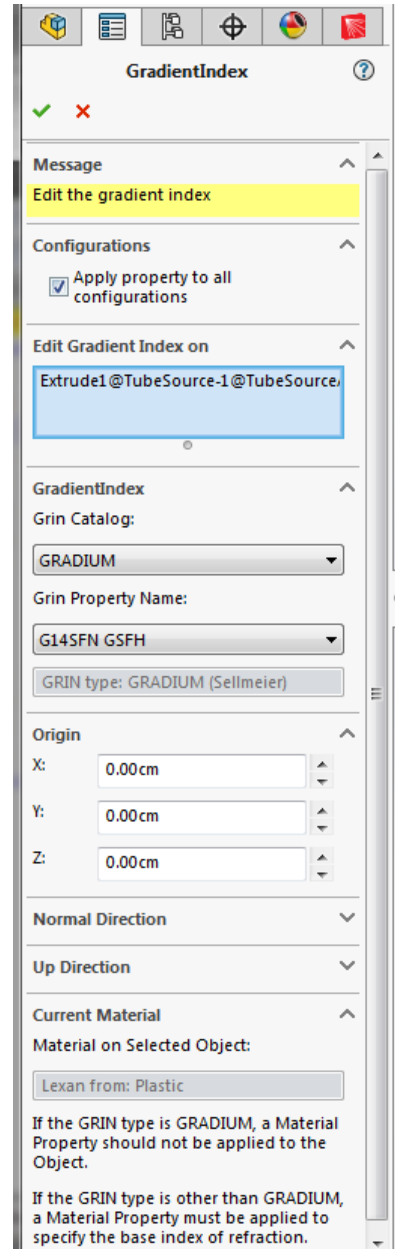

**Figure 4.5** Gradient Index Property Manager

- Click the **green checkmark** to apply the changes.
- Check that the new property is clearly visible in the System Tree.

## Bulk Scattering Standard Expert

Bulk scatter is scatter caused by particles and inclusions within a material. A bulk scattering property works together with an object's material property. Such properties should be defined in TracePro and brought into RayViz through the Property Database.

To apply Bulk Scattering to an object:

- Apply a Material property on the part (see the Material Property section in this chapter).
- Select an object in your model. Right-click on the object in the System Tree, Feature Manager or Graphics Window. The same property can be applied to multiple objects by selecting more than one object and then right-clicking on one of the selected objects.
- Select the **Bulk Scatter** option on the drop-down menu.
- The **Message** area indicates what you are supposed to do, while the Configurations group controls whether the property is applied to the current configuration or to all configurations.
- In the **Bulk Scatter** Property Manager, select the **Scatter Catalog** you want to build your property from, then choose a **Scatter Property Name** from that catalog.
- The **Type and Description** of the scatter model is shown in the lower section of the dialog box. With complex scatter models, these are very useful to make sure that the correct one has been selected.

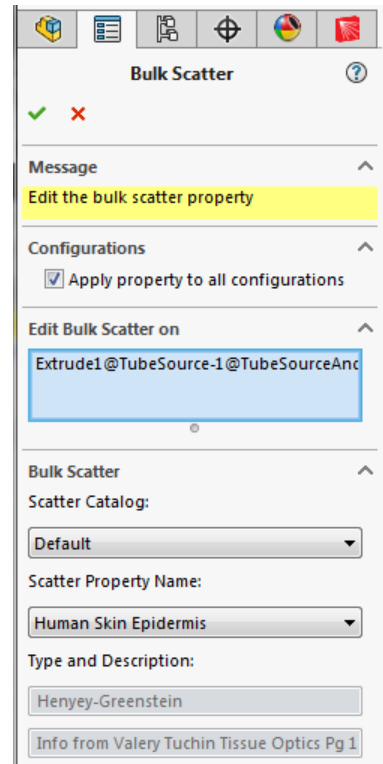

**Figure 4.6** Bulk Scatter Property Manager

- Check that the property's characteristics are the correct ones.
- Click the **green checkmark** to apply the changes.
- Check that the new property is clearly visible in the System Tree.

## Fluorescence Standard Expert

Fluorescence Properties apply to materials that emit at different wavelengths after they absorb incident radiation. Thus, by determining the amount of absorbed radiation from the initial ray-trace wavelengths, secondary rays can be emitted at new wavelengths.

To apply Fluorescence to an object:

- Select an object in your model. Right-click on the object in the System Tree, Feature Manager or Graphics Window. The same property can be applied to multiple objects by selecting more than one object and then right-clicking on one of the selected objects.
- Select the **Fluorescence** option on the drop-down menu.
- The **Message** area indicates what you are supposed to do, while the Configurations group controls whether the property is applied to the current configuration or to all configurations.
- In the **Fluorescence** Property Manager, select the Catalog in the first field and Name in the second field.
- Enter values for the **Quantum Efficiency**, **Peak Molar Extinction**, and **Molar Concentration** fields. These fields determine the concentration of fluorescence materials and the conversion efficiency to the secondary wavelength(s).
- Add Fluorescence emission waveband edges and enter the number of wavelengths (**# Inc**) within each band. Emission rays will be generated at each wavelength. You can easily exclude the zero-to-first-wavelength band by entering 0 for the **# Inc** value. The last-wavelength-to-infinity band can be excluded by selecting the check box.
- Existing waveband edges can be modified if a single row is selected in the list box. You can change either the **Wavelength**, **#Inc** or both. Just change the values and click **Modify**.
- You can also delete existing wavebands by selecting one or more in the list box and clicking the **Delete** button.
- Check that the property's characteristics are the correct ones.
- Click the **green checkmark** to apply the changes.
- Check that the new property is clearly visible in the System Tree.

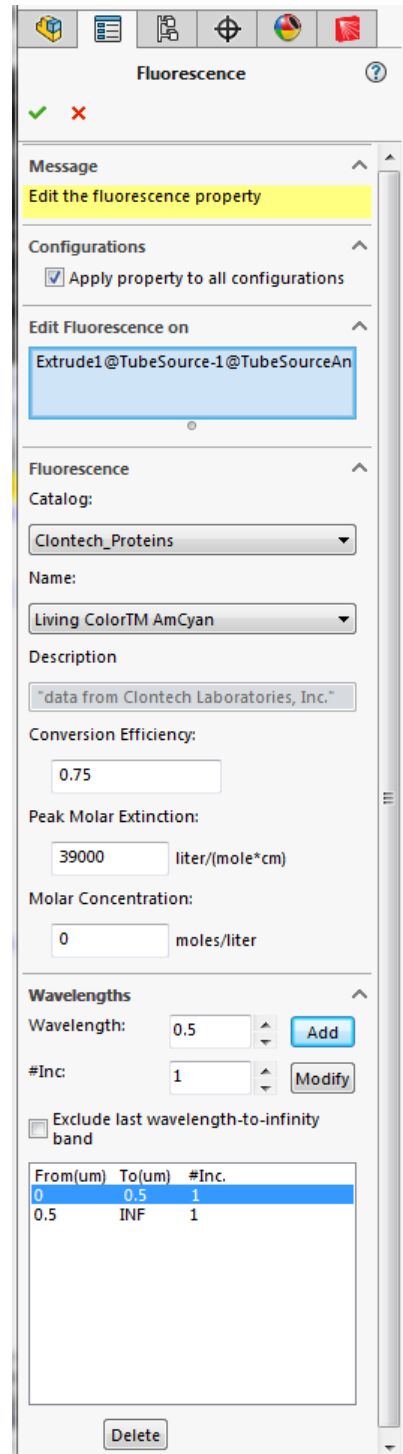

**Figure 4.7** Fluorescence Property Manager

## Temperature Standard Expert

TracePro has a Surface and an Object property for temperature. Material and Surface properties have data based on wavelength and temperature. During the ray trace audit the property data is updated to reflect the current surface and object temperatures. If an object has a defined temperature but the surfaces do not, the object temperature is applied to the surfaces. If no temperature is defined, the default value for the property is used.

As an example, consider a simple material property named “Temperature,” which has an index of 1.5 for 300 K and 2.5 at 500 K. The ray trace for the two cases is made in TracePro with the results dependent (highly in this case!) due to the large index modification with temperature change.

Temperature is entered in units of degrees C, degrees F, or Kelvin and is applied like any other property, through the Apply Property Manager.

To apply Temperature to an object:

- Select an object (or surface) in your model. Right click on the object in the System Tree, Feature Manager or Graphics Window. The same property can be applied to multiple objects by selecting more than one object and then right-clicking on one of the selected objects. You can choose surfaces, objects, or a mix of both.
- Select the **Temperature** option on the drop-down menu.
- The **Message** area indicates what you are supposed to do, while the Configurations group controls whether the property is applied to the current configuration or to all configurations.
- In the **Temperature** Property Manager, enter the **Temperature** you want to apply to the selected item(s) then choose a temperature **unit**.
- Check that the property’s characteristics are the correct ones.
- Click the **green checkmark** to apply the changes.
- Check that the new property is clearly visible in the System Tree.

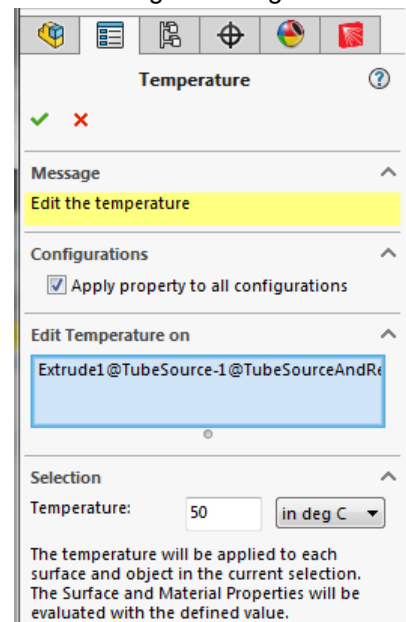

**Figure 4.8** Temperature Property Manager

## Importance Sampling Standard Expert

Importance sampling is a Monte Carlo technique in which rays are generated and propagated in specific directions in the optical system. These directions are “important” in the sense that lead to better and faster results that you need. This process improves sampling by increasing the number of rays reaching the surface or surfaces of interest to you. For a conceptual explanation of Importance Sampling, see “Importance Sampling” on page 7.2 in the *TracePro User's Manual*.

Importance Sampling can be applied to improve ray sampling for the following applications:

- Surface Scatter,
- Bulk Scatter,
- Diffraction, and
- Surface Sources.

The solid angles for importance sampling are defined by circular, annular, or rectangular patches called importance sampling targets. These targets are not part of the solid model and are used only for importance sampling. These Importance Targets are defined in one of two ways, manually or automatically. The Automatic Setup of Importance Sampling can be used for optical systems for which a sequential prescription of surfaces can be defined. Models containing multiple potential stray light paths require manual setup of the targets. It is also possible to use the Automatic Setup to define Importance targets, and then add additional targets manually. There are two classes of importance sampling targets, one for surfaces and one for objects. Surface importance sampling targets are applied to surfaces and affect rays generated from surfaces, i.e., surface scatter, aperture diffraction and surface sources. Object Importance sampling targets are used for generating bulk scattered rays. Once Importance Sampling targets have been defined, they can also be edited, deleted, and displayed.

To manually apply Importance Sampling to an object:

You can manually specify importance sampling targets. The Importance Sampling targets dialog box allows you to directly specify the location, orientation, and dimensions of importance sampling targets. You can choose either Rectangular or Annular importance targets.

- Select an object in your model. Right-click on the object in the System Tree, Feature Manager or Graphics Window. The same property can be applied to multiple objects

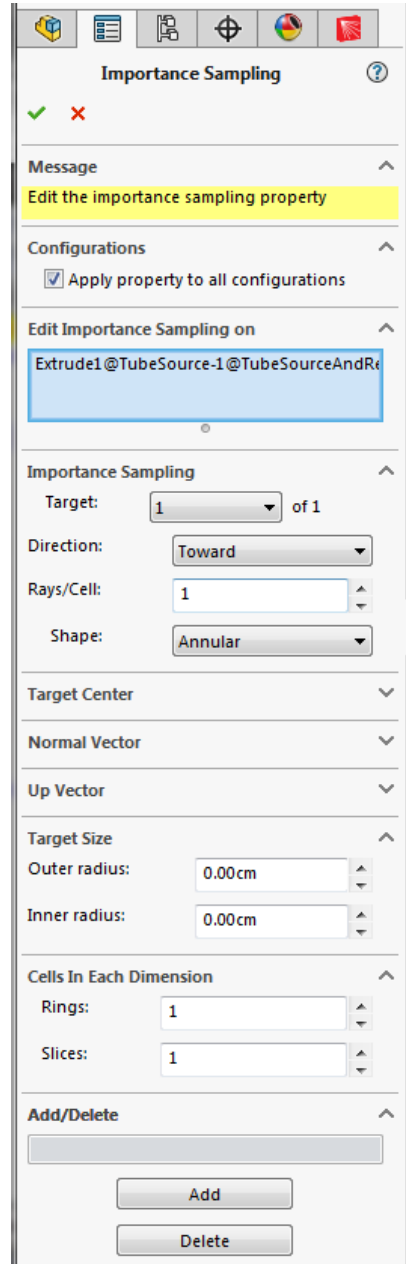

**Figure 4.9** Importance Sampling Property Manager

by selecting more than one object and then right-clicking on one of the selected objects.

- Select the **Importance Sampling** option on the drop-down menu.
- The **Message** area indicates what you are supposed to do, while the Configurations group controls whether the property is applied to the current configuration or to all configurations.
- Click on the **Add** button.
- Specify the **Direction** of the importance rays (either **Toward** or **Away** from the target).
- Specify the number of importance **Rays/Cell**. This is the number of rays generated upon scatter, diffraction, and so forth that are directed to or away from the Importance Target.
- Select the **Shape** of the importance sampling target (**Annular** or **Rectangular**) and enter the parameters for the location, orientation, and dimensions of the target.
- **Target Center** (collapsed): Specify the coordinates x, y, and z to establish the position of the importance sample surface.
- **Normal Vector** (collapsed): Specify the direction x, y, and z to establish the target normal.
- **Up Vector** (collapsed): Specify the direction x, y, and z to establish the up direction or height. It must be orthogonal to the **Normal Vector**.
- **Target Size**: Specify **Outer** and **Inner Radius** for Annular targets or the X and Y widths for Rectangular targets. An annular region with a zero inner radius is a circle.
- **Cells In Each Dimension**: Specify the number of segments that the target is divided up into. One segment is the default.
- **Add** button: Click this button to add an importance sampling target as currently defined by the rest of the dialog box. To associate importance sampling with a particular surface, you must first select that surface in your model before you press the Add button.
- **Delete** button: Press this button to delete the displayed Importance Sampling.
- Check that the property's characteristics are the correct ones.
- Click the **green checkmark** to apply the changes.
- Check that the new property is clearly visible in the System Tree.

Importance sampling collects the flux from a random ray, caused by scattering for example, and aims it towards the defined target. The flux can be divided into multiple rays to improve the sampling of the ray trace by directing many rays toward each importance sampling target. If the importance sampling target subtends too large a solid angle OR the BSDF of the surface varies significantly (more than an order of magnitude) over the subtended angle OR if more sampling is desired, divide the target into cells. This step ensures better sampling of the target.

Rectangular segments are all the same shape as well as being equal in area. To specify the segmentation of an importance sampling target, select the number of cells in each direction (radius and angle for an annular target, x and y for a rectangular target).

Shape, Dimensions, and Location of Importance Targets: When setting up importance sampling targets manually, it is important that the solid angle subtended by the importance sampling target is less than one steradian. It might be necessary to select multiple samples to keep the solid angle of each segment small. This is especially important if the BSDF varies strongly with angle (for example, for a polished surface such as a mirror or lens). Reducing the size of the target or using multiple cells can overcome this issue.

When it is important to have more uniform sampling than is provided by pure random sampling, use importance sampling to divide each dimension of the target into segments, creating smaller cells in which random ray aiming points are selected.

Automatic Importance Sampling is done within TracePro. Please consult the TracePro User's Manual for more information.

## Raytrace Flag

The ray trace flag property lets you exclude an object from a ray trace, which can speed up the ray trace. During the audit prior to the start of a ray trace, messages are displayed in the Macro/Message Window to remind you which surfaces you have excluded from the ray trace. To exclude an object from the ray trace, select the object. Mark the check box on the Ray Trace Flag option dialog box.

To apply Raytrace Flag to an object:

- Select an object in your model. Right-click on the object in the System Tree, Feature Manager or Graphics Window. The same property can be applied to multiple objects by selecting more than one object and then right-clicking on one of the selected objects.
- Select the **Raytrace Flag** option on the drop-down menu.
- The **Message** area indicates what you are supposed to do, while the Configurations group controls whether the property is applied to the current configuration or to all configurations.
- In the **Raytrace Flag** Property Manager, check/uncheck the Remove from Raytrace check box.
- Check that the property's characteristics are the correct ones.
- Click the **green checkmark** to apply the changes.
- Check that the new property is clearly visible in the System Tree.

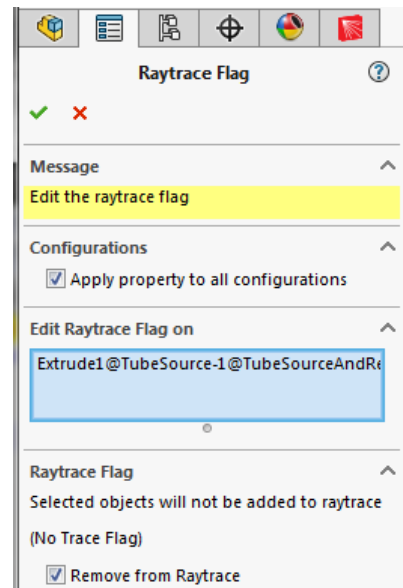

**Figure 4.10** Ray Trace Flag Property Manager



## Surface Applicable Properties

### Surface

Surface properties provide physical data for absorptance, scatter (BRDF and BTDF), specular reflectance, and specular transmittance. In RayViz, surface properties are identified by name and catalog, and are stored in a database. For detailed descriptions of the components of surface properties such as BRDF and BTDF, see Chapter 7, “Technical Reference” in the *TracePro User's Manual*.

To apply Surface properties:

- Select an object (or surface) in your model. Right click on the object in the System Tree, Feature Manager or Graphics Window. The same property can be applied to multiple objects by selecting more than one object and then right-clicking on one of the selected objects. You can choose surfaces, objects, or a mix of both. When objects are selected the surface property will apply to all surfaces on the object.
- Select the **Surface** option in the drop-down menu.
- The **Message** area indicates what you are supposed to do, while the Configurations group controls whether the property is applied to the current configuration or to all configurations.
- In the **Surface** Property Manager, select a surface property **Catalog** and **Name** from the drop-down lists.
- For **Asymmetric Scatter** a checkbox is included for using a fixed axis for zero-azimuth. It is used for anisotropic scatter.
- Check that the property's characteristics are the correct ones. Some information could be displayed in the **Description** and **Reference Data** boxes. For direction-sensitive surfaces (e.g., 2-sided gratings), the user is informed of its properties through the **Grating Data** area.
- Click the **green checkmark** to apply the changes.
- Check that the new property is clearly visible in the System Tree.

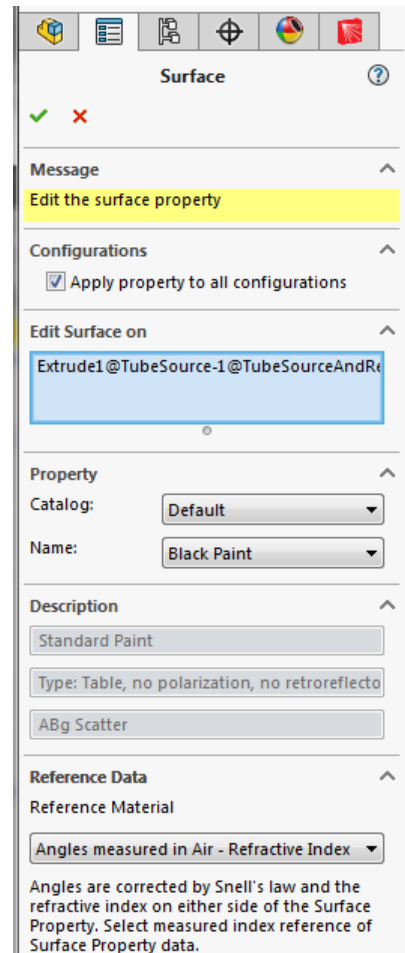

Figure 4.11 Surface Property Manager

## Surface Source Properties

A surface source is a surface that is designated to emit rays in a ray trace. There are five types of surface source properties in RayViz. Two types emit discrete wavelengths (flux and irradiance). The other two types emit continuous wavebands (blackbody and graybody). The fifth type, Surface Source Property, can emit either discrete wavelengths or calculated wavelengths.

To apply Surface Source to a surface:

- Select a surface in your model. Right-click on the surface in the System Tree, Feature Manager or Graphics Window. The same property can be applied to multiple surfaces by selecting more than one surface and then right-clicking on one of the selected surfaces.
- Select the **Surface Source** option in the drop-down menu.
- The **Message** area indicates what you are supposed to do, while the Configurations group controls whether the property is applied to the current configuration or to all configurations.
- In the **Surface Source** Property Manager, specify the Surface Source property type. The option that you select changes the fields on the Surface Source tab. Select from the following: Source Property, Flux (Figure 4.12), Irradiance, Blackbody or Graybody. The property manager pages for the other types are shown in Figure 4.13. The Source Types are described below.
- Select the **Units** (Flux or Irradiance source only).
- Enter values for the **Flux** (Flux source), **Irradiance** (Irradiance Source), or **Temperature** (Blackbody or Graybody source). Graybody also asks you for the Emissivity.
- Select an angular distribution (**Angular Dist**) (except for Surface Source Property type). You can choose **Lambertian**, **Uniform**, **Normal to Surface**, or **Surface Absorptance**. The latter requires you to input a surface property with angular distribution data.
- Select the **Rays** to be emitted. In most cases this is set to **All Rays**.
- Enter the minimum number (**Min Rays**) of rays for any wavelength.

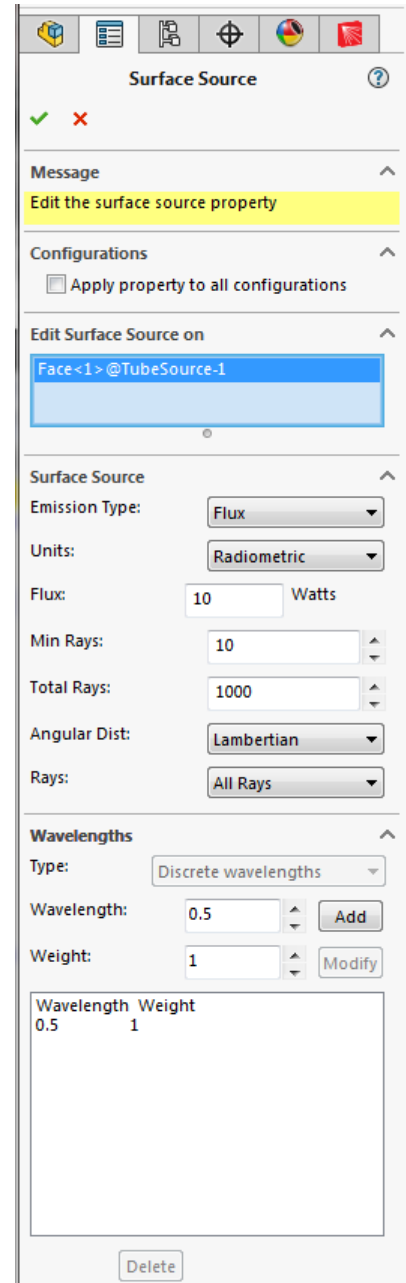

**Figure 4.12** Surface Source Property Manager – Flux Emission Type

- Enter the total number (**Total Rays**) of rays for this surface source.
- For a Surface Source Property Surface, select **Discrete wavelengths** or **Calculated wavelengths** for the type of wavelength data.
- Enter as many wavelengths as you need: type in each wavelength in  $\mu\text{m}$ , then click the **Add** button in the Wavelengths group.
- For discrete wavelengths, edit **Weight** as needed. They can be set when the wavelength is added or modified after selecting a single row in the list box.

Existing wavelengths can be modified if a single row is selected in the list box. You can change either the **Wavelength**, **Weight** or both. Just change the values and click **Modify**.

You can also delete existing wavelengths by selecting one or more in the list box and clicking the **Delete** button.

- For calculated wavelengths, edit **#Inc** as needed for each waveband. You can easily exclude the zero-to-first-wavelength band by entering 0 for the **# Inc** value. The last-wavelength-to-infinity band can be excluded by selecting the check box

Existing waveband edges can be modified if a single row is selected in the list box. You can change either the **Wavelength**, **#Inc** or both. Just change the values and click **Modify**.

You can also delete existing wavebands by selecting one or more in the list box and clicking the **Delete** button.

- Check that the property's characteristics are the correct ones.
- Click the **green checkmark** to apply the changes.
- Check that the new property is clearly visible in the System Tree.

## Emission Type

Figure 4.13 shows the property manager pages for the other emission types. The following bullets describe each of the emission types. There are five types of surface source properties in RayViz. Two types emit discrete wavelengths (flux and irradiance). The other two types emit continuous wavebands (blackbody and graybody). The fifth type, Surface Source Property, can emit either discrete wavelengths or calculated wavelengths.

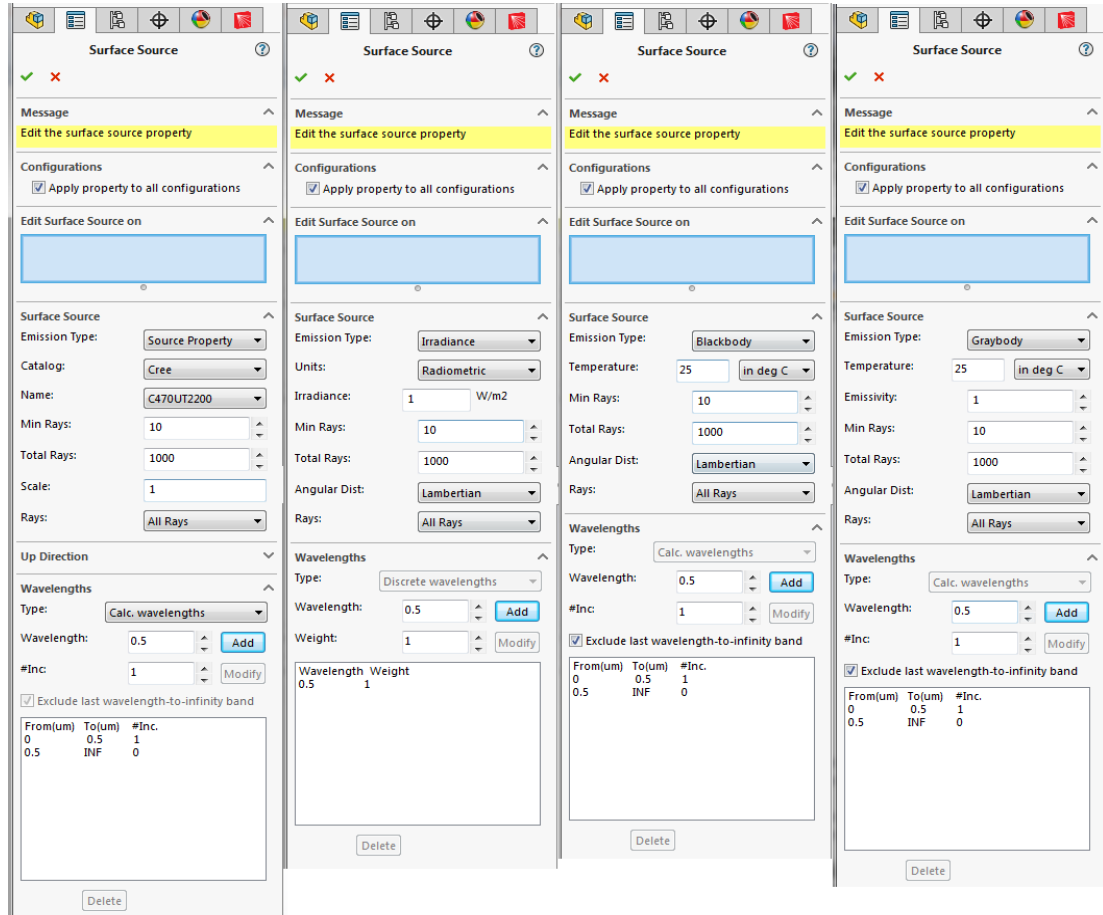

Figure 4.13 Surface Source Property Manager – For Source Property, Irradiance, Blackbody and Graybody.

- **Source Property:** Uses a Surface Source Property to determine the spectral distribution units, and total flux or irradiance to be emitted by the surface source. Uses either discrete wavelengths (see Flux or Irradiance below) or calculated wavelengths (see Blackbody or Graybody below).
- **Flux:** The total power emitted by a surface. Flux source surfaces distribute the power uniformly over their surface area. The light rays are emitted from the surface at random positions. Flux source surfaces emit rays in discrete wavelengths.
- **Irradiance:** Irradiance source surfaces distribute power per unit area. Thus, a larger total area provides a higher total flux. They use discrete wavelengths.
- **Blackbody:** Blackbody source surfaces require a temperature value and continuous wavebands to calculate irradiance on a source surface. RayViz uses wavebands to

represent a continuous spectrum. It calculates a spectrally weighted wavelength to represent each waveband. In the calculation, RayViz distributes the number of rays per waveband to generate rays with approximately equal flux. The **Min Rays** field specifies the minimum number of rays assigned by calculation to each waveband.

- **Graybody:** Graybody source surfaces require a temperature, an emissivity value, and continuous wavebands to calculate irradiance on a source surface. RayViz uses wavebands to represent a continuous spectrum. It calculates a spectrally weighted wavelength to represent each waveband. In the calculation, RayViz distributes the number of rays per waveband to generate rays with approximately equal flux. A graybody calculation uses the value in the **Emissivity** field for determining power distribution over the surface. The **Min Rays** field specifies a minimum number of rays assigned by calculation to each waveband. Source Units Specify the number and type of units, either Watts or lumens (Flux), Watts per Sq. Meter or lux (Irradiance), or Temperature (Blackbody and Graybody). A drop-down list is displayed for temperature providing options for Kelvin, degrees C and degrees F.

**Units:** Specify the type of units, either Radiometric or Photometric (Flux or Irradiance sources only).

**Min Rays:** Specify the minimum number of rays assigned (by RayViz calculation) to each wavelength.

**Total Rays:** Request a number of rays to emit from a surface source. For a Flux or Irradiance (discrete wavelength) raytrace, exactly the requested number of rays will be traced. For a Blackbody or Graybody (continuous wavebands) raytrace, RayViz will calculate the number of rays based on the values entered, with the requested number as the goal. The actual number of rays to be traced is displayed in the Wavelengths grid.

**Emissivity:** For a graybody specify a number from zero to 1 to indicate the emissivity. The number is used in the calculation of flux emitted by the surface.

**Angular Dist:** Select Lambertian, Normal to Surface, Surface Absorptance, or Uniform. Surface Sources emit light in one of the four angular distributions. Specifying angles and probabilities for the rays is important for the accuracy of the raytrace.

Lambertian — Emits radiation with a cosine-weighted angular distribution.

Normal to Surface — Emits radiation in a direction perpendicular to the surface. This option allows you to use a sphere to generate a diverging spherical wavefront (as from a point source) or the inside of a spherical shell to generate a converging spherical wave

Surface Absorptance — Uses the absorptance vs. angle of incidence profile specified by the surface's Surface Property as an angular emissivity distribution for emitting rays. The wavelength dependence is also used as the spectral emissivity for blackbody and graybody sources.

Uniform — Generates rays uniformly into a hemisphere. This allows you to use a flat surface to simulate a point source, i.e. one with a spherical symmetry.

**Discrete Wavelengths:** Here, a wavelength refers to a single discrete wavelength. For a raytrace that uses many wavelengths, RayViz lets you optionally specify a mathematical weight for each wavelength to enhance or diminish the role of the wavelength in calculations.

**Calculated Wavelengths:** The From and To limits of each waveband are shown. There can be many wavebands used in a raytrace calculation. RayViz calculates zero or more spectrally-weighted wavelengths for each waveband, as determined by the #Inc entry. Rays are traced at the spectrally-weighted wavelengths. Calculated wavelengths are used with Source Property, Blackbody, and Graybody surface sources.

## Prescription Standard Expert

Prescription lets you specify the sequence of lens surface intersections through which an image-forming ray travels. TracePro uses prescription (list of surfaces) for three things:

- Sorting ray paths,
- Automating the set-up of importance-sampling targets, and
- Testing against the Optical Scatter Intercept Limit during the ray trace.

The sequence is entered such that a sequential list of surfaces is obtained, which is required because TracePro is a non-sequential ray-trace program. You specify the sequence of intersections manually. A prescription number of -1 applied to a surface means that the surface is not part of the optical prescription.

To apply Prescription to a surface:

- Select a surface in your model. Right-click on the surface in the System Tree, Feature Manager or Graphics Window.
- Select the **Prescription** option in the drop-down menu.
- The **Message** area indicates what you are supposed to do, while the Configurations group controls whether the property is applied to the current configuration or to all configurations.
- Check that the property's characteristics are the correct ones.
- Click the **green checkmark** to apply the changes.
- Check that the new property is clearly visible in the System Tree.

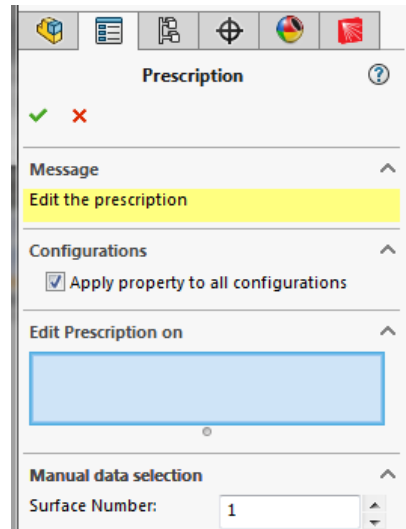

**Figure 4.14** Prescription Property Manager

## RepTile Surfaces Expert

When modeling objects that have many small repeated structures, it may be infeasible to create the structures using a solid modeling program. For example, brightness-enhancing films used in flat-panel LCDs may have thousands or millions of repeated surface structure elements.

The RepTile surface feature in TracePro allows you to create these objects by specifying the shape of one tile, or one column of tiles. This feature allows you to create complicated models with a great reduction in model size, audit time, and ray-trace time compared to

equivalent models with solid geometry. This feature can also be applied to surfaces in SOLIDWORKS thanks to RayViz. While you can apply this property in SOLIDWORKS, you cannot see it until you open the file in TracePro. A new type of RepTile structure is called Textures. A Texture is a file that defines the shape of the small structures; however, the parameterization of the placement and size of these features might not be readily apparent. Typically, these Texture files are developed in CAD or other programs. They are then assigned to RepTile Texture properties within TracePro that can then be assigned in RayViz.

The process of applying a RepTile surface in SOLIDWORKS is similar to applying a Surface property. TracePro has a database of different RepTile surface shapes and geometries that can be accessed through the **RepTile** Property Manager. Different tile shapes (ring, rectangular, staggered rectangular, and hexagonal) and tile geometries (conical, spherical, ellipsoidal, hip-roof, cube-corner, prism, rounded prism, and Fresnel lens) are available.

In general, the geometries can be defined as either “bumps” or “holes”. Once a RepTile property is entered in the database it can be applied to a plane surface using the **RepTile** Properties Manager. Additional data is also needed, namely a boundary (rectangular or circular) on the plane surface within which the tiles exist and the location of a reference tile (the (0, 0) tile). This data is entered in the **Boundary** and **Orientation** box of the **RepTile** Properties Manager.

To apply RepTile to a surface, use the following steps:

- Select a surface in your model. Right-click on the surface in the System Tree, Feature Manager or Graphics Window.
- Select the **RepTile** option in the drop down menu.
- The **Message** area indicates what you are supposed to do, while the Configurations group controls whether the property is applied to the current configuration or to all configurations.
- In the **RepTile** Property Manager, specify the **Catalog** and the **Name** of the RepTile model to use. Then, specify the surface property by selecting the **Catalog** and **Name** of the desired property.
- Enter the **Boundary Type** as well as its dimensions, **Radius** or **Width** and **Height**. Define the **Boundary Center**, the **Origin for tile (0,0)**, **Tile Up** (not shown), and **Boundary Up** (not shown).
- Check that the property's characteristics are the correct ones.

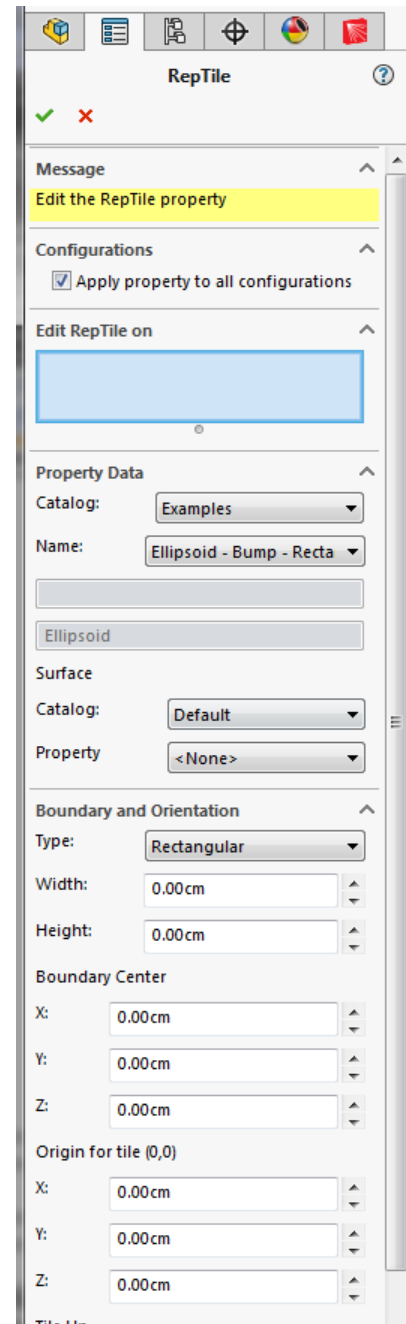

Figure 4.15 RepTile Property Manager

- Click the **green checkmark** to apply the changes.
- Check that the new property is clearly visible in the System Tree.

The **Tile Up** vector you enter when applying the RepTile Surface property to a surface determines the orientation of tiles in a RepTile surface. The direction of the **Tile Up** vector defines the local y-axis of the tiles, the plane normal vector defines the local z-axis, and the local x-axis is orthogonal to the y and z axes and forms a right-handed coordinate system. The boundary is oriented according to the **Boundary Up** vector entered. The height of the boundary is measured along the **Boundary Up** vector. The width of tile shapes and geometry is the dimension along the local x-axis, and the height is along the local y-axis (the **Tile Up** vector). Depth/height of “bumps”/“holes” is along the local z-axis.

When you specify a circular boundary, TracePro creates a disk-shaped cell to contain the tiles. When you specify a rectangular boundary, TracePro creates a rectangular cell to contain the tiles.

**Note:** A single body can have multiple RepTile properties assigned to it, as long as the RepTile surfaces are planar. TracePro does not allow RepTile properties to be assigned to non-planar surfaces.

**Temperature**

See the Temperature property of the same name in the Object Applicable Property section.



## Temperature Distribution Standard Expert

A temperature distribution property allows for non-uniform temperature distributions over a surface. The surface shapes compatible with this feature are rectangular (e.g., a plane with a rectangular boundary), circular (e.g., a plane with a circular boundary), and cylindrical (e.g., the curved side of a cylinder, with each end perpendicular to the cylinder's axis). The distribution information is stored in an ASCII (txt) file, and can be defined by a two-dimensional array of points along the surface, with bilinear interpolation between the given points or a polynomial expression, up to the fifth order, with user-defined coefficients.

- Select a surface in your model. Right-click on the surface in the System Tree, Feature Manager or Graphics Window.
- Select the **Temperature Distribution** option in the drop down menu.
- The **Message** area indicates what you are supposed to do, while the Configurations group controls whether the property is applied to the current configuration or to all configurations.
- In the **Temperature Distribution** Property Manager, specify the **Path** file to use. The **Type** is then listed under the path name.
- Enter values for the various points (**Origin**, **LocalX** and **LocalZ**). You can add new points by clicking the **Next Point** button or Flip the LocalZ coordinates by clicking the **Flip LocalZ** button.
- You can delete the distribution by clicking on the Delete Distribution.
- Check that the property's characteristics are the correct ones.
- Click the **green checkmark** to apply the changes.
- Check that the new property is clearly visible in the System Tree.

See “Non-Uniform Temperature Distributions” on page 7.61 of the *TracePro User's Manual* for further information.

## Importance Sampling Standard Expert

See the Importance Sampling of the same name in the Object Applicable Property section.

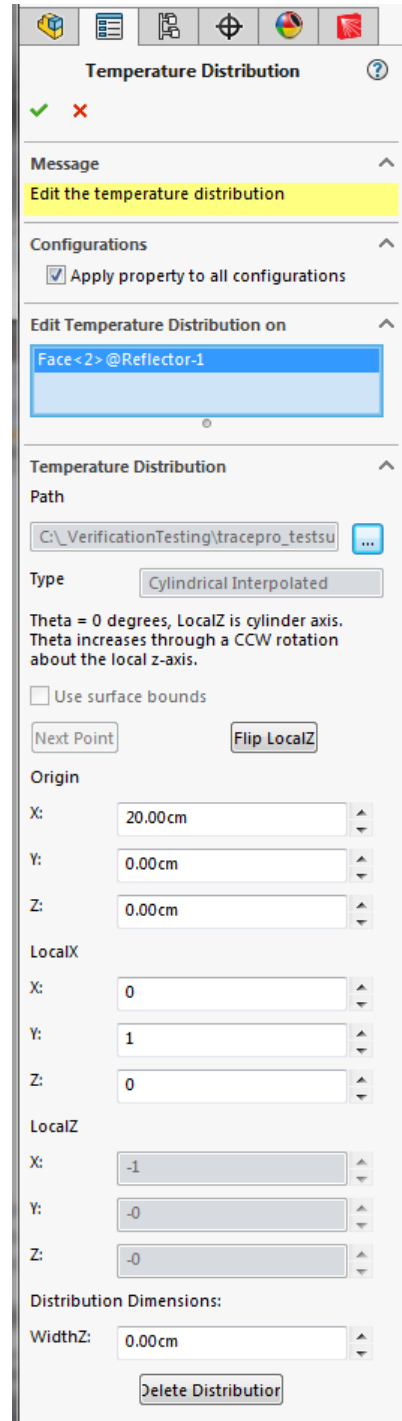

**Figure 4.16** Temperature Distribution Property Manager

## Exit Surface

When using Simulation Mode in TracePro to reduce the length and burden of computations, you must designate one or more surfaces as Exit Surfaces to display Irradiance Maps. You can do the same with the SOLIDWORKS RayViz if you know the model is used in that specific mode. The Exit Surface dialog is used to define the number of Reverse Rays to trace when using Reverse Ray trace.

TracePro optionally collects flux and incident ray coordinates and directions for each surface in addition to collecting data for candela plots. Rays do not necessarily “exit” on this surface, but this is a commonly used term for this surface. Once the Exit Surfaces are defined, rays may be traced in Simulation Mode.

- Select a surface in your model. Right-click on the surface in the System Tree, Feature Manager or Graphics Window. The same property can be applied to multiple surfaces by selecting more than one surface and then right-clicking on one of the selected surfaces.
- Select the **Exit Surface** option in the drop down menu.
- The **Message** area indicates what you are supposed to do, while the Configurations group controls whether the property is applied to the current configuration or to all configurations.
- Check the **Exit Surface** checkbox and if doing a reverse ray trace of Radiance/Luminance modeling enter the number of reverse rays desired.
- **Add** or **Modify** the irradiance map orientation desired after the ray trace in TracePro. You can name or rename the orientation and enter the normal and up vectors.
- You can also delete your orientations by selecting one and clicking the Delete button.
- Check that the property's characteristics are the correct ones.
- Click the **green checkmark** to apply the changes.
- Check that the new property is clearly visible in the System Tree.

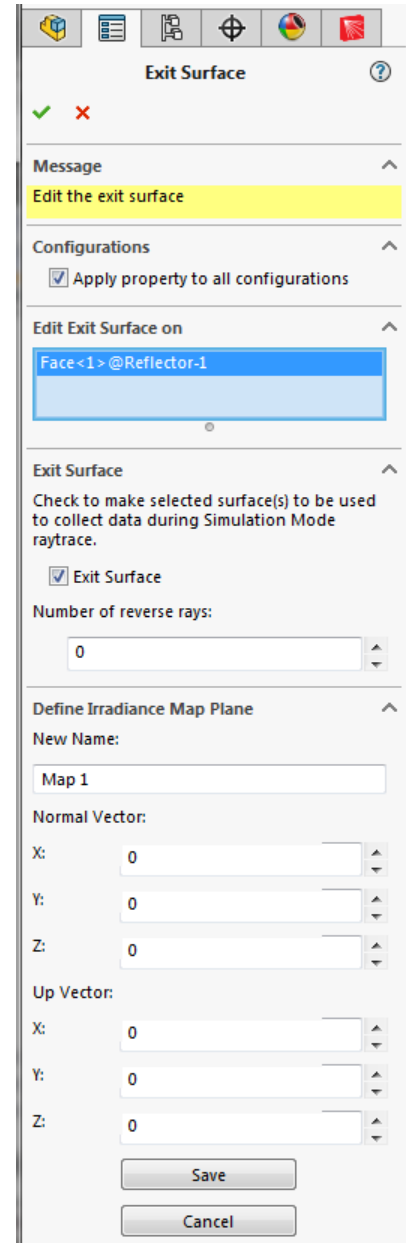

**Figure 4.17** Exit Surface Property Manager

## Diffraction Standard Expert

Aperture diffraction is light “bending around obstacles.” TracePro can model edge diffraction, also called aperture diffraction, which occurs when light is partially blocked by an edge. The

method TracePro uses for modeling diffraction is asymptotically correct, i.e., it is correct for large-angle or wide-angle diffraction. A more complete discussion of the diffraction model used in TracePro is given in the Technical Reference section. (See “Aperture Diffraction Example” on page 9.22 of the *TracePro User's Manual*.)

TracePro's implementation of diffraction modeling is designed for stray light analysis and for system transmission studies of specialized optical instruments where diffraction might have a significant effect on transmittance. Generally, image quality diffraction studies are done using optical design software such as OSLO. If you are modeling diffraction for stray light, it is necessary to define importance sampling for each diffracting aperture in the optical system. The importance sampling target for the diffracting aperture is applied to the surface that is defining the edge of the aperture. Diffraction occurs in TracePro at a surface on which a diffraction property is defined.

Setting up diffraction on a surface:

- Select a surface in your model. Right-click on the surface in the System Tree, Feature Manager or Graphics Window. The same property can be applied to multiple surfaces by selecting more than one surface and then right-clicking on one of the selected surfaces.
- If there is no surface where you want to model diffraction, you must define a “dummy object.” Locate the dummy object where you want the diffraction to occur, and select one surface of the object.
- Select the **Diffraction** option in the drop-down menu.
- The **Message** area indicates what you are supposed to do, while the **Configurations** group controls whether the property is applied to the current configuration or to all configurations.

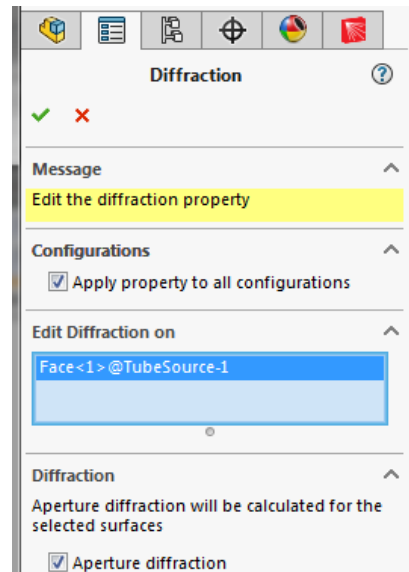

**Figure 4.18** Diffraction Property Manager

- Place a check in the **Aperture Diffraction** check box to turn on diffraction effects.
- In TracePro, it is also necessary to set the **Aperture Diffraction** check box in the **Ray trace Options** dialog box found in the **Analysis** menu. This turns on diffraction for the current model. Optionally, set the **Diffraction Distance** in the **Ray trace Options** dialog box. This information lets you limit model calculations to an area within a specified distance. The **Aperture Diffraction distance** is the maximum distance in millimeters from the diffraction edge at which the user wants the model rays to be calculated. Beyond that distance, it is assumed that rays proceed undeviated (i.e., they behave in a geometrical nature). If you are not sure how to use this setting, leave it at its default value.
- Check that the property's characteristics are the correct ones.
- Click the **green checkmark** to apply the changes.
- Check that the new property is clearly visible in the System Tree.

## Chapter 5 – Ray Tracing

### Introduction to Ray Tracing

Ray Tracing is the means by which RayViz simulates the distribution of flux throughout a model. This chapter contains the logic behind ray tracing in RayViz and the techniques you can use to enhance your raytrace.

How your rays interact with your model is partly determined by your model itself (the geometrical details of the objects you created and the properties you applied), and partly determined by how you control the rays being launched into your model.

### Why Monte Carlo Ray Tracing?

In RayViz modeling, the Monte Carlo method is used to simulate the scattering and diffraction of light, and to sample of the distributions of rays emanating from light sources. In the absence of scattering and diffraction processes, light travels in discrete directions which are exactly modeled by ray tracing. However, when light scatters from a surface, it produces a continuous distribution of light. One could in principle calculate the propagation of light exactly by propagating this distribution to the next surface, then cascade this distribution with the distribution produced by the next surface, and so on, until the irradiance in the light field is so low that it can be neglected. To model light propagation in this way can require an enormously complicated computer program.

The Monte Carlo method is a technique for computing the outcome of random processes. It is used for modeling quantum-mechanical processes that can only be described by their statistics. Monte Carlo as applied to the propagation of light can also be described as a technique for numerical integration. As such it is used when conventional numerical integration techniques cannot be used because the problem to be solved is not amenable to those techniques.

In Monte Carlo ray tracing, scattering and diffraction are treated as random processes. Instead of propagating a distribution of light, discrete samples of the distribution, or rays, are propagated. The samples are randomly chosen, using the scattering distribution as a probability density. This allows the well-developed techniques of ray tracing to be used to model scattering.

In “brute force” Monte Carlo ray tracing, the directions of rays are chosen randomly, and a reliable answer is obtained by tracing a very large number of rays. RayViz makes use of variance reduction techniques to reduce the number of rays required to get a reliable result.

### Surface Sources

A surface source emits rays in a prescribed angular distribution from one or more surfaces of solid objects in the Model. Surface sources are defined as Surface Properties and are described in Chapter 4 - Applying Properties. See **Surface Source Properties** on page 30.

### Standard (Forward) Raytrace

Standard or Forward raytracing is the method used to simulate the flux propagation in a RayViz model. Rays will emanate from all of the sources defined in the model as described above. Initiating the raytrace is done by selecting Tools|RayViz|Trace Rays or pressing the Trace Rays button on the RayViz tab of the CommandManager.

Most sources are defined as using “discrete wavelengths”. Surface sources defined as Blackbody or Graybody sources will use “calculated wavelengths.” Surface Sources that use a Surface Source Property may use either discrete wavelengths or calculated wavelengths.

The raytrace begins when Tools|RayViz|Trace Rays is selected or when the CommandManager button is clicked. During the raytrace a progress dialog box opens to indicate progress of the raytrace. You can interrupt or pause the raytrace at any time by clicking Cancel on the Raytrace Progress dialog box and RayViz will finish tracing the current ray. You can resume the raytrace by selecting Raytrace|Resume Raytrace. The raytrace resumes starting at the next consecutive ray number in the raytrace.

## Raytrace Options

The Raytrace Options group from the options dialog, as shown in Figure 3.5, controls the flux threshold and the intercept limits. Thresholds control the raytrace by providing limits on how long RayViz follows a ray. The most commonly used limit is the flux threshold. Rays started by RayViz from a source are traced and split until the flux carried by a ray component is below the threshold. At that point, that branch of the ray tree is terminated.

The raytrace can also be controlled by limiting the number of intercepts. The number of intercepts is the number of ray-surface intersections that a particular ray path contains. You can terminate rays based on the Total number of ray-surface intercepts for a ray path.

For each starting ray, this controls the number of intercepts allowed along each path. A ray will be terminated after it reaches the set intercept limit. This limit directly controls the depth of the ray tree by controlling the number of nodes or branch points, while the flux threshold indirectly controls it.

## Chapter 6 - Workflows

### How to work with RayViz for SOLIDWORKS

This chapter goes over the different methodologies engineers and designers may use when developing and modeling imaging or lighting designs and products in a virtual environment. This chapter walks through the workflow on how users should use RayViz for SOLIDWORKS to fit their particular needs and how it enhances the design process. The typical workflow in RayViz is shown in Figure 6.1.

RayViz was created for designers making complex CAD models that need to include optical ray tracing. Users build a geometry model in SOLIDWORKS, apply optical and source properties to the geometry, raytrace and then display the traced rays. At this point the user can then check the system for vignetting, crosstalk, imaging, and stray light issues. Any correction and modification can then be done directly in SOLIDWORKS and the workflow sequence can then be repeated as many times as necessary during the design process.

The final option in the Workflow process, exporting to TracePro saves optical properties directly within the original SOLIDWORKS part or assembly to a TracePro file. This reduces the step of having to reapply optical properties within TracePro, bringing the design process to completion faster than ever. Furthermore, designers have access to much more complex designs in SOLIDWORKS, complete with adjustments, mates and shapes. While the TracePro geometry generation engine is simple to use, the user base is larger for SOLIDWORKS.

The following sections are summaries of different workflows and provide brief discussions on how RayViz for SOLIDWORKS can enhance the optical design and analysis process.

### Typical Workflow in RayViz

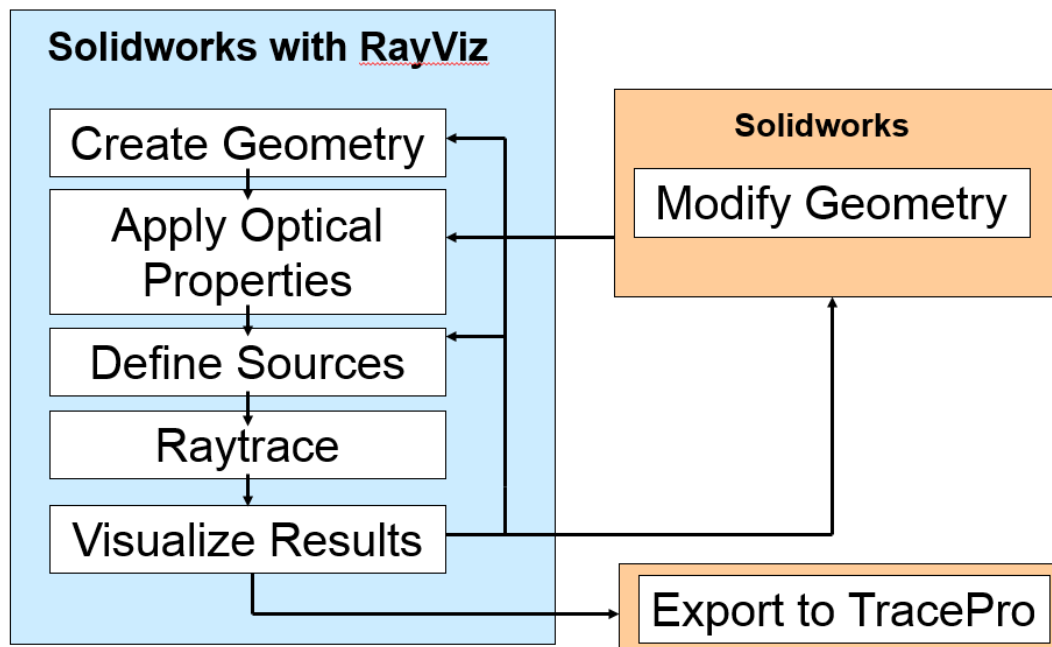
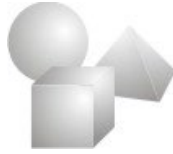

Figure 6.1 – Typical workflow in RayViz



## Workflow: Working exclusively with RayViz in SOLIDWORKS (CAD)

### For SOLIDWORKS-only users:

RayViz can be used to do simple ray tracing on both optical and illumination systems. The basic workflow is for users to apply source and optical properties to their model and then do simple ray tracing to validate these designs using user-defined criteria. The user can then either increase the number of rays or vary the optical properties and sources to create a more robust validation of their model. The final step is an iterative process to change either the properties or geometry to meet their user-defined criteria of the model.

Let's look at an example of the workflow of analyzing an imaging system in SOLIDWORKS using RayViz. For purely image-forming designs where sequential ray tracing is the only requirement, or for a simple CAD design with no prior optical work performed, RayViz for SOLIDWORKS can be seen as a gateway to performing a simple optical analysis check on a finalized product, enhancing the optical performance by checking for vignetting or focusing, or tolerancing for better optical system performance.

For commonplace products that can use light passively (through ambient or source light piping) or actively (using LEDs, bulbs, and so forth), RayViz for SOLIDWORKS can be another gateway to analyze power and angular distribution, color distribution by tracing different wavelengths, and ultimately, the illumination effectiveness of the design. Any SOLIDWORKS model, be it a part or assembly, can be made "optical" and tested in TracePro to make sure the optical or lighting performance meets demands.

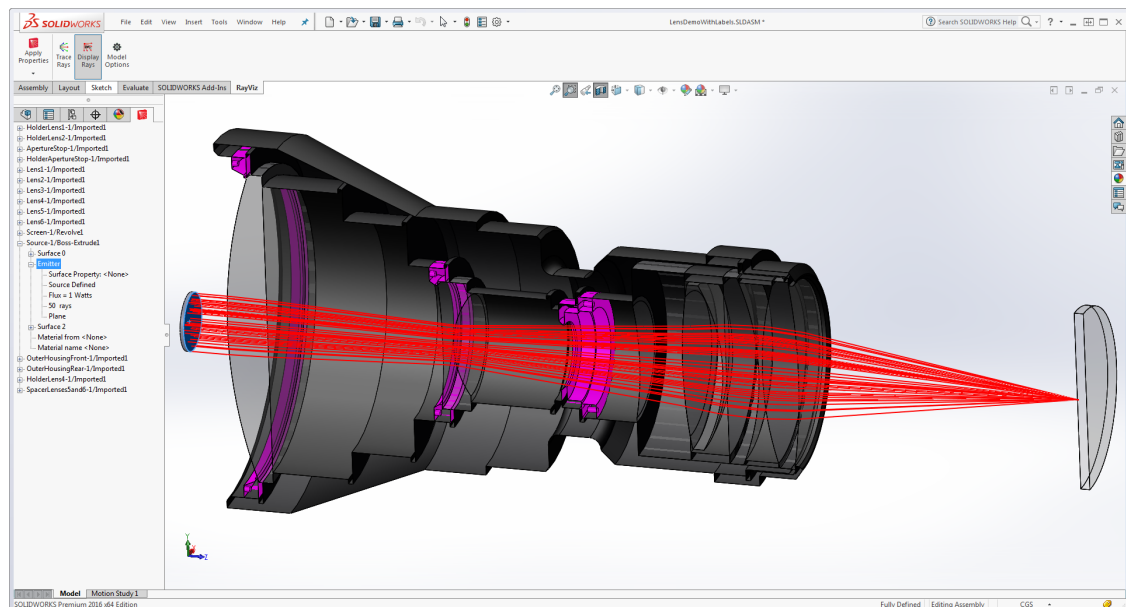
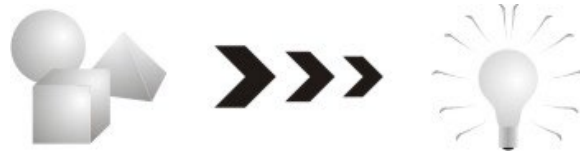

Figure 6.2 – Complex lens design with baffles and ray trace to check vignetting and imaging



### **Workflow: SOLIDWORKS (CAD) to TracePro (Non-Sequential Ray Tracing)**

This workflow option involves taking a design that may or may not have been first designed in a lens design program, completing it in SOLIDWORKS, and then sending it to TracePro for final analysis. In this scenario, designers start directly within SOLIDWORKS by importing the model, and then update the functionality as a product update or a new feature. After the optical and mechanical features and enclosures are modeled, the optical properties are applied directly in SOLIDWORKS using RayViz. To verify the optical properties applied in the model are correct, the user should do a quick raytrace to verify that the source or sources are correctly setup and that all optical properties are applied correctly to the geometry. Best practice is to start with a small number of rays and verify each section of the model. The work can then be saved both as SOLIDWORKS and TracePro files. The next step is to an optical analysis of the system in TracePro if required.

After the initial optical analysis in TracePro, designers can study the results and optical outputs and compare them to the design goals and metrics. Because of the similarities between SOLIDWORKS and TracePro when RayViz is in use, conclusions from the analysis that end up justifying modifications to the models can now be made on a single platform. The results and redesigns are accessible to both parties, as product designers and engineers who do the optical analysis may or may not be the same individuals.

Several design iterations might be necessary, so the same process can be pursued until the design is optically optimized, and the optical properties only had to be applied once. This method requires less time and ensures quality and version control, especially when multiple individuals are involved.

Take, for example, a custom telescope lens as shown in Figure 6.2. The lens can be designed, toleranced and optimized in a lens design program such as OSLO. The lens system is then introduced in SOLIDWORKS to build the mechanical parts and the final enclosure with mechanical mounts. Once this is completed, designers have to analyze the effects introduced by the mechanical assembly on its optical performance (e.g., stray light analysis and other factors might influence the choice of materials and other more significant design changes). A quick ray trace in RayViz can be completed to check for vignetting, focusing, crosstalk, and straylight issues. If further analysis is needed, the completed assembly can be exported to a TracePro file and the design can be further evaluated. The results dictate if changes need to be made, which can then be completed within SOLIDWORKS.

Another example could be a product enclosure upgraded with LED lights and a light piping system. Since the light piping needs to be able to send light where it is required, several design iterations may be demanded. While the design may vary quite a bit in the process, all optical properties are still included in the original SOLIDWORKS model, and no consecutive reapplications are needed for each ray trace which can be accomplished right in RayViz

Simply apply the optical properties to the models, save them directly in SOLIDWORKS to TracePro's format, and then ray trace them in TracePro. This way image-forming designs can eliminate stray light effects through subtle redesigns in SOLIDWORKS. TracePro is a tool that enables users to see what really needs to be changed when there are limitations inherent to the design. Analyzing a model in TracePro helps the creation of optimal performance more quickly.

In this case access to TracePro software is necessary to synchronize RayViz with a TracePro database and to carry out the ray trace and analysis.



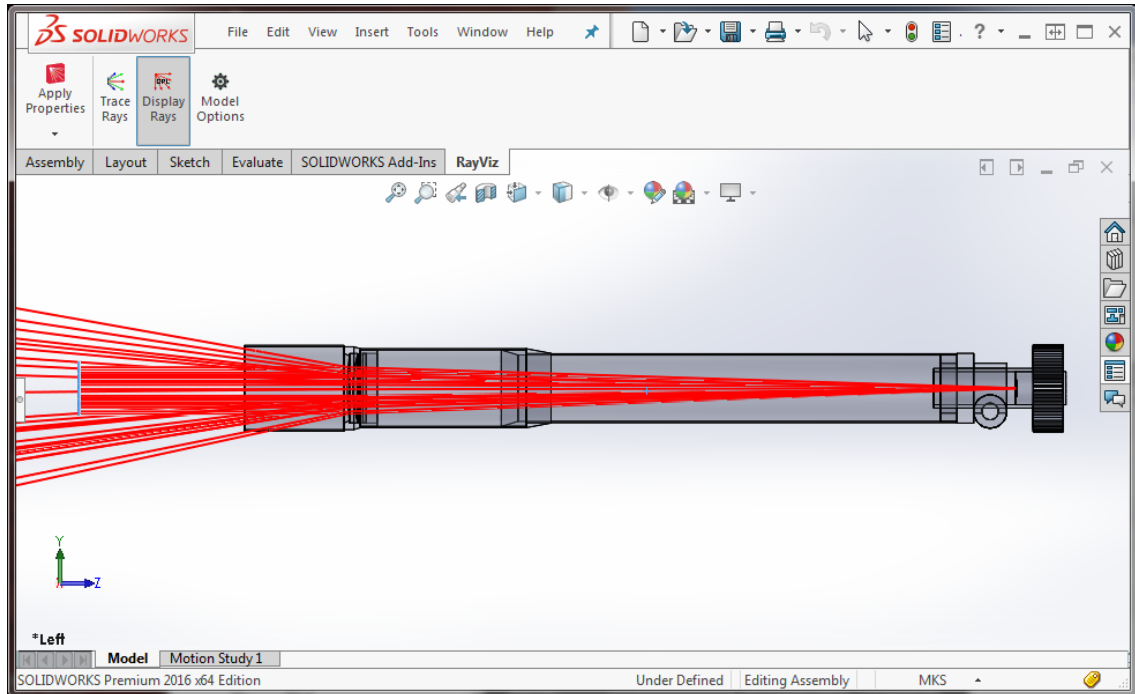

**Figure 6.3** - Simple telescope design with lenses imported from an optical design program.

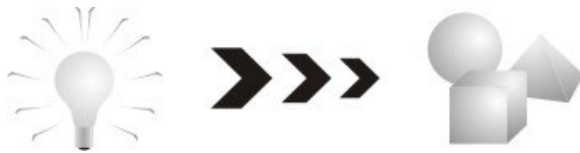

### **Workflow: TracePro (Non-Sequential Ray Tracing) to SOLIDWORKS (CAD)**

In this particular case, users start a design in TracePro for some preliminary non-sequential testing and proof of concept. Next the design is taken to a CAD program for mechanical fit checking and packaging. Most of the time, TracePro designs end up completely replaced by refined updated geometry from SOLIDWORKS.

Some designs might benefit from going through TracePro before they are translated into a SOLIDWORKS model. Reasons for doing so might include the following: the need to insert a particular structure that TracePro can build more quickly and accurately (such as baffles or Fresnel lenses), the absence of any specific workspace limitations or other mechanical enclosure constraints, and/or the need for a very simple concept demonstration before an accurate model is designed. Other reasons might include the user comfort level with SOLIDWORKS versus the use of TracePro defined geometry building methods, or the simple need for a third-party file healing and translation into a SOLIDWORKS-readable format.

In general, we recommend the use of RayViz for this workflow because the manipulation of geometry is simply more flexible in SOLIDWORKS, and since most of the product design is done in SOLIDWORKS, using a single design platform is preferred. Since the TracePro System Tree is integrated into SOLIDWORKS when RayViz is active, optical designers should feel more at home in the SOLIDWORKS environment.

Because of the number of mechanical parts involved and possible design compromises done during the entire process, a final optical analysis stage is recommended to do checks on the optical

performance of the design. As such, ray tracing a finalized virtual design is a valuable safety measure to make sure the optical system is performing as originally designed.



### **Workflow: Working exclusively with TracePro (Non-Sequential Ray Tracing)**

#### **For TracePro-only users:**

For optical designers who are already accustomed to sequential and non-sequential ray tracing programs, the use of simple models is the rule. The virtual tools are easy to use, but restrictive in terms of design flexibility. Dealing with the real world sensibilities of mechanical assemblies that get in the way of optical performance and compromises with the mechanical designers and engineers have been a constant reality for decades.

SOLIDWORKS offers a simpler, more accessible way to get more flexibility in terms of design. With RayViz for SOLIDWORKS and its TracePro-like system tree interface, optical designers can now feel more at ease. Designers are now free to build more accurate and complex models and communicate freely with their mechanical specialists. This is accomplished because they are equivalent on the same SOLIDWORKS platform when it comes to virtual modeling optical systems. Not only is the ease of use and the flexibility increased, but also time savings are considerable, as much of the work does not need to be redone each time a design compromise or change becomes necessary.

As mentioned before, this makes SOLIDWORKS the best design platform for CAD modeling, allowing the design intent as well as additional data to be shared with mechanical designers and engineers. Models no longer have to be built from the ground up multiple times, simplifying the file and process management and the entire workflow.

Remember that RayViz requires SOLIDWORKS as well as TracePro before it can be fully functional. To complete the ray tracing and analysis of a model, TracePro can be located on another computer, on the condition that both computers use synchronized TracePro databases.

## Best Practices:

In RayViz for SOLIDWORKS there are some practices that will make the operation run more smoothly and efficiently. The list below elucidates upon these.

1. Using the RayViz System Tree for anything other than optical property application is not recommended.
2. Build multi-component designs as assemblies, not as a single part. This allows for the application of various material and surface properties rather than limiting the model to just a few, which need to be applied to the entire structure.
3. If you are also using TracePro, make sure you use the same TracePro property database when working with models on different computers and when specifying which property database to use with RayViz. This ensures that every model raytraced in RayViz or TracePro gives the same results and files saved as a TracePro file are traced with the correct optical properties.
4. Be sure to verify the **Analysis>>Ray Trace Options** in TracePro before you do a ray trace. These Options are not set within RayViz, and they can drastically affect analysis results.