



Software for Opto-Mechanical Modeling

User's Manual

Release 2022

Revised 7-July-2022

Lambda Research Corporation
25 Porter Road
Littleton, MA 01460

support@lambdares.com

COPYRIGHT AND TRADEMARK ACKNOWLEDGMENTS

COPYRIGHT

The TracePro® software and manual are Copyright © 2022 by Lambda Research Corporation. All rights reserved.

This software is provided with either a single user license or a network license. A single user license may only be used by one user and on one computer at a time. A network license may be used by one or more users, up to the number purchased for the network license, on any computer connected to the license server via the network.

The TracePro manual contains proprietary information. This information as well as the rest of the manual may not be copied in whole or in part, or reproduced by any means, or transmitted in any form without the prior written consent of Lambda Research Corporation.

TRADEMARKS

TracePro and OSLO are registered trademarks of Lambda Research Corporation.

RayViz, TracePro Bridge, and RepTile are trademarks of Lambda Research Corporation.

The following are trademarks or registered trademarks of Kubotek Corporation in the USA and/or other countries: KUBOTEK® KUBOTEK3D™ KEYCREATOR® KUBOTEK KOSMOS KCM

ACIS is a registered trademark of Spatial Corporation.

Autodesk and Autodesk Inventor are registered trademarks of Autodesk, Inc.

Code V is a registered trademark of Synopsys, Inc.

PRO-E and Pro/ENGINEER are registered trademarks of Parametric Technology Corporation. Wildfire is a trademark of Parametric Technology Corporation.

SolidWorks is a registered trademark of SolidWorks Corporation.

Windows is a registered trademark of Microsoft Corporation in the United States and other countries.

ProSource is a registered trademark of Radiant Zemax

Zemax is a registered trademark of Zemax.

CodeMeter® is a registered trademark of WIBU-SYSTEMS AG.

LICENSE AGREEMENT

The purchaser of TracePro is granted a license to use this product subject to the following restrictions and limitations.

1. The license is to the original purchaser only, and is not transferable without written permission of Lambda Research Corporation.
2. With a single-user license, only one copy of the software may be used on a single computer at a time. The software may be transferred for use on another computer, but the software may not be used simultaneously on more than one computer unless additional licenses are purchased for each multiple simultaneous use.
3. A network license may be used by one or more users, up to the number purchased for the network license, on any computer connected to the license server via the network. The license may be transferred to a different server computer by moving the license key and installing the license server software on the new server computer.
4. The original purchaser may make backup copies of the original software for his own use only, subject to the use limitations of this license agreement.
5. The original purchaser may not engage in, or permit third parties to engage in, any of the following:
 - a. Providing the use of the software in a computer service business, network, or time-sharing use to users who are not individually licensed by Lambda Research Corporation.
 - b. Making alterations or copies of any kind in the software except as specifically permitted above.
 - c. Attempting to disassemble, decompile, or reverse engineer the software in any way.
 - d. Attempting to defeat the hardware key or license manager software.
6. You may not use or otherwise export or re-export the licensed product except as authorized by United States law and the laws of the jurisdiction in which the licensed product was obtained. In particular, but without limitation, the licensed product may not be exported or re-exported (a) into any U.S. embargoed countries or (b) to anyone on the U.S. Treasury Department's list of Specially Designated Nationals or the U.S. Department of Commerce Denied Person's List or Entity List. By using the licensed product, you represent and warrant that you are not located in any such country or on any such list. You also agree that you will not use these products for any purposes prohibited by United States law, including, without limitation, the development, design, manufacture or production of missiles, or of nuclear, chemical, or biological weapons.

WARRANTY

Although Lambda Research Corporation has made every effort to ensure that TracePro is technically accurate, Lambda Research makes no representations or warranties of any kind whatsoever, directly or indirectly, with respect to the contents hereof or the software described herein. Lambda Research shall not be liable for errors contained herein or with the software described herein for

any incidental or consequential damages caused by, or in connection with, the furnishing, performance, use of, or any inability to use this product.

With respect to the physical CD-ROM, hardware key, and documentation enclosed herein, Lambda Research warrants the same to be free of defects in materials and workmanship for a period of thirty days from the date of purchase. Lambda Research will replace the defective CD-ROM, key, or documentation within this warranty period upon receipt of the defective product. Lambda Research reserves the right to make changes to the TracePro software or documentation without obligation to notify any person of such revision or change.

DOCUMENT CONVENTIONS

The following conventions are used throughout the TracePro manual.

Menu items and menu sequences are shown as **Define|Edit Property Data|Material Properties**. The sequence will be to select the Define Menu, then the Edit Property Data Menu and finally the Material Properties Menu.

Functions available to a certain Edition of TracePro are indicated by the following Edition Icons.

	TracePro Expert
	TracePro Standard
	TracePro LC

Text shown in this format is to be typed or viewed in a text editor.

CHAPTER 1

Introduction 1

What is TracePro?	1
<i>Why Solid Modeling?</i>	1
<i>How Does TracePro Implement Solid Modeling?</i>	2
<i>Why Monte Carlo Ray Tracing?</i>	2
The TracePro Graphical User Interface	3
<i>Toolbars</i>	3
<i>Model Window</i>	4
<i>Multiple Models in Multiple Views</i>	5
<i>System Tree Window</i>	6
<i>Context Sensitive Menus</i>	9
<i>User Defaults</i>	11
<i>Objects and Surfaces</i>	11
<i>Modeless Dialog Boxes</i>	15
Context Sensitive OnLine Help	17
Command Line Arguments	18
Using a Language other than English	19

CHAPTER 2

Creating a Solid Model 1

Introduction to Solid Modeling	1
<i>Model Units</i>	1
<i>Position and Rotation</i>	1
Defining Primitive Solid Objects	2
<i>Block</i>	3
<i>Cylinder/Cone</i>	3
<i>Torus</i>	4
<i>Sphere</i>	5
<i>Thin Sheet</i>	6
<i>Rubberband Primitives</i>	8
Defining TracePro Solids	9
<i>Lens Element</i>	9
<i>Fresnel Lens</i>	22
<i>Reflector</i>	24
<i>Tube</i>	33
<i>Baffle Vane</i>	33
Boolean Operations	35
Moving, Rotating, and Scaling Objects	37
Sweeping and Revolving Surfaces	42
<i>Notes Editor</i>	44
Importing and Exporting Files	45
<i>CAD Translators</i>	45
<i>Plot formats for model files</i>	46
<i>Lens Design Files</i>	47
<i>Merging Files</i>	49
<i>Inserting Files</i>	49
<i>Update from RayViz</i>	49
Changing the Model View	50
<i>Zooming</i>	51

<i>Panning</i>	52
<i>Rotating the View</i>	52
<i>Named Views</i>	52
<i>Controlling the Appearance of Objects</i>	53
<i>View Options</i>	56
<i>Changing Colors</i>	64
Photorealistic Rendering	64
<i>Photorealistic Rendering Setup</i>	65
<i>Photorealistic Rendering Options</i>	66

CHAPTER 3

Defining Properties 1

Overview	1
<i>What is a property?</i>	1
<i>Define or Apply Properties</i>	1
Property Editors	1
<i>Toolbars and Menus</i>	3
<i>Command Panel</i>	3
<i>Information Panel</i>	4
<i>Grid Panel</i>	4
Material Properties	5
<i>Material Catalogs</i>	5
<i>Material Property Database</i>	5
<i>Create a new material property</i>	6
<i>Editing an existing material property</i>	7
<i>Exporting a material property</i>	7
<i>Importing a Material Property</i>	8
<i>Bulk Absorption</i>	8
<i>Birefringence</i>	9
Bulk Scatter Properties	9
<i>Bulk Scatter Property Editor</i>	10
<i>Import/Export</i>	11
<i>Scatter DLL</i>	12
Fluorescence Properties	12
<i>Defining Fluorescence Properties</i>	13
<i>Using the Fluorescence Property Generator</i>	14
<i>Fluorescence Calculations</i>	14
<i>Fluorescence Ray Trace</i>	15
Surface Source Properties	17
<i>Surface Source Property Editor</i>	17
<i>Create a New Surface Source Property</i>	18
<i>Edit an Existing Surface Source Property</i>	19
<i>Export a Surface Source Property</i>	19
<i>Import a Surface Source Property</i>	19
<i>Using The Surface Source Property Generator</i>	20
Gradient Index Properties	20
<i>Gradient Index Property Editor</i>	20
<i>Create a New Gradient Index Property</i>	21
<i>Edit an Existing Gradient Index Property</i>	22
<i>Export a Gradient Index Property</i>	22
<i>Import a Gradient Index Property</i>	22

Surface Properties	23
<i>Using the Surface Property Database</i>	23
<i>Using the Surface Property Editor</i>	23
<i>Creating a new surface property</i>	29
<i>Editing an Existing Surface Property</i>	29
<i>Exporting a Surface Property</i>	30
<i>Importing a Surface Property</i>	30
<i>Surface Property Plot Tab</i>	30
<i>Table BSDF</i>	33
<i>Using The BSDF Converter</i>	41
<i>Using BSDF Properties</i>	42
<i>Wire Grid Polarizers</i>	43
Thin Film Stacks	43
<i>Using the Stack Editor</i>	44
<i>Thin Film Stack Editing Note</i>	44
BSDF Properties	47
<i>Using the BSDF Property Editor</i>	48
<i>Importing and Exporting BSDF Properties</i>	49
RepTile Surfaces	49
<i>Overview</i>	49
<i>Specifying a RepTile surface</i>	49
<i>RepTile Parameterization</i>	77
<i>Decentering RepTile Geometry</i>	82
Property Database Tools	83
<i>Update Property Database</i>	83
<i>Import</i>	83
<i>Export</i>	84

CHAPTER 4

Applying Properties **1**

Using Properties	1
<i>Limitations in Pre-Defined Property Data</i>	1
<i>Applying Property Data</i>	1
Material Properties	4
<i>Material Catalogs</i>	4
<i>Applying Material Properties</i>	4
<i>Applying Birefringent Material Properties</i>	5
Bulk Scattering	6
Fluorescence Properties	7
<i>Applying Fluorescence Properties</i>	8
Gradient Index Properties	9
Surface Properties	10
<i>Using the Surface Property Database</i>	11
Surface Source Properties	12
<i>Blackbody Surface Sources</i>	17
<i>Blackbody and Graybody Calculations</i>	18
Prescription	18
Color	19
Importance Sampling	20
<i>Defining Importance Sampling Targets Manually</i>	21

<i>Automatic Setup of Importance Sampling</i>	26
<i>Editing/Deleting Importance Sampling Targets</i>	29
Exit Surface	30
<i>Predefined irradiance map orientation</i>	31
Diffraction	32
<i>Defining Diffraction in TracePro</i>	32
<i>Do I need to Model Diffraction in TracePro?</i>	32
<i>How do I Set Up Diffraction?</i>	33
Using the Raytrace Flag	33
Mueller Matrix	33
Temperature	36
Class and User Data	38
RepTile Surfaces	39
<i>Overview</i>	39
<i>Specifying a RepTile surface</i>	40
Temperature Distribution	53
<i>Applying a temperature distribution</i>	54

CHAPTER 5

Ray Tracing and Optimization 1

Introduction to Ray Tracing	1
<i>Combining Sources</i>	1
<i>Managing Sources with the System Tree</i>	1
<i>Managing Sources with the Source/Wavelength Selector</i>	2
Defining Sources	3
<i>Grid Sources</i>	3
<i>Surface Sources</i>	22
<i>File Sources</i>	22
<i>Image Sources</i>	26
30	
<i>Ray File Wavelength Editor</i>	30
31	
<i>Source Builder</i>	31
<i>Orienting and Selecting Sources</i>	32
<i>Multi-Selecting Sources</i>	32
<i>Move and Rotate Dialogs</i>	33
<i>Sources Editor</i>	34
Tracing Rays	36
<i>Standard (Forward) Raytrace</i>	36
<i>Reverse Ray Tracing</i>	36
<i>Luminance/Radiance Ray Tracing</i>	38
Raytrace Options	41
<i>Options</i>	42
<i>Thresholds</i>	46
<i>Simulation and Output</i>	47
<i>Simulation Options for TracePro LC</i>	48
<i>Advanced Options</i>	49
Ray Tracing modes	54
<i>Analysis Mode</i>	54
<i>Simulation Mode</i>	55

Optimization	58
<i>Interactive Optimizer</i>	58
<i>Texture Optimizer II</i>	58

CHAPTER 6

Analysis 1

Examining Raytrace Results	1
Analysis Menu	1
<i>Display Rays</i>	1
<i>Ray Colors</i>	1
<i>Path Sort Table</i>	3
<i>Irradiance Maps</i>	7
<i>Luminance/Radiance Maps</i>	18
<i>3D Irradiance/Illuminance</i>	21
<i>Candela Plots</i>	26
<i>Polarization Maps</i>	42
<i>OPL/Time-of-flight plot</i>	45
<i>Incident Ray Table</i>	49
55	
<i>Ray Files - Binary file format</i>	55
<i>Ray Histories</i>	55
<i>Ray Sorting</i>	58
Reports Menu	63
<i>Flux Report</i>	63
<i>Property Data Report</i>	64
<i>Raytrace Report</i>	64
<i>Saving and Restoring a Raytrace</i>	64
Tools Menu	65
<i>Audit</i>	65
<i>Delete Raydata Memory</i>	65
<i>Collect Volume Flux</i>	66
<i>View Volume Flux</i>	68
<i>Simulation File Manager</i>	71
<i>Irradiance/Illuminance Viewer</i>	72
<i>Candela Plot Viewer</i>	75
<i>Analysis Toolkit</i>	76
<i>Solar Emulator</i>	77
<i>IES/LDT Plots</i>	77
<i>Lighting Toolkit</i>	77
<i>Stray Light Analyzer</i>	77
<i>Measurement Dialog</i>	78

CHAPTER 7

Technical Reference 1

Introduction	1
The Use of Ray Splitting in Monte Carlo Simulation	1
Importance Sampling	2
<i>Importance Sampling and Random Rays</i>	3
<i>When Do I Need Importance Sampling?</i>	4
<i>How to Choose Importance Sampling Targets</i>	4
<i>Importance Sampling Example</i>	5

Material Properties	6
<i>Material Property Database</i>	7
<i>Gradient Index Profile Polynomials</i>	9
<i>Complex Index of Refraction</i>	14
Surface Properties	15
<i>Coincident Surfaces</i>	15
<i>BSDF</i>	15
<i>Asymmetric BSDF</i>	19
<i>Calculation of Fresnel coefficients during raytrace</i>	26
<i>Anisotropic Surface Properties</i>	26
<i>User Defined Surface Properties</i>	28
<i>Angles Measured in Substrate</i>	48
Surface Source Properties	51
<i>Spectral types</i>	52
<i>Angular Types</i>	55
Mueller Matrices and Stokes Vectors	57
Bulk Scattering	61
<i>Henyey-Greenstein Phase Function</i>	61
<i>Gegenbauer Phase Function</i>	62
<i>Scattering Coefficient</i>	62
<i>Using Bulk Scattering in TracePro</i>	62
<i>User Defined Bulk Scatter</i>	63
Non-Uniform Temperature Distributions	68
<i>Overview</i>	68
<i>Distribution Types</i>	68
<i>Defining Temperature Distributions</i>	72
<i>Format for Temperature Distribution Storage Files</i>	73
<i>Polynomial Approximations of Temperature Distributions</i>	83
Interpretation of Polar Iso-Candela Plots	90
Property Import/Export Formats	93
<i>Material Property Format</i>	93
<i>Surface Property Format</i>	94
<i>Stack Property Format</i>	98
<i>Gradient Index Property Format</i>	99
<i>Bulk Scatter Property Format</i>	105
<i>Fluorescence Property Format</i>	106
<i>Surface Source Property Format</i>	107
<i>RepTile Property Format</i>	109

CHAPTER 8

Using the Macro Language 1

The Scheme Language	1
<i>Notepad++</i>	2
<i>Macro Recorder</i>	2
<i>Macro Command Examples</i>	3
<i>Running a Macro Command from the Command Line</i>	4
<i>Running a Scheme Program Stored in a File</i>	4
Creating Geometry	5
<i>Create a solid block:</i>	5
<i>Create a solid block named blk1:</i>	5
<i>Create a solid cylinder:</i>	5

<i>Create a solid elliptical cylinder:</i>	5
<i>Create a solid cone:</i>	6
<i>Create a solid elliptical cone:</i>	6
<i>Create a solid torus:</i>	6
Boolean Operations	7
<i>Boolean subtract</i>	7
<i>Boolean unite</i>	7
<i>Boolean intersect</i>	7
Macro Programs	7
Accessing TracePro Menu Selections using Scheme	7
For more information on Scheme	7
TracePro COM Interface	8
<i>TracePro COM</i>	8
<i>TracePro Type Library</i>	8
<i>TracePro<edition> Object</i>	8
<i>TracePro Interface</i>	9
<i>Changing the TracePro COM server</i>	10
TracePro DDE Interface	10
<i>Introduction</i>	10
<i>TracePro DDE Server</i>	11

CHAPTER 9

Examples **1**

RepTile Examples	1
Aperture Diffraction Example	22
<i>Applying Importance Sampling to a Diffracting Surface</i>	26
Volume Flux Calculations Example	29
Sweep Surface Example	33
Revolve Surface Example	36
Using Copy with Move/Rotate	38
Anisotropic Surface Property	41
<i>Creating an anisotropic surface property in TracePro</i>	42
<i>Applying an anisotropic surface property to a surface</i>	42
Elliptical BSDF	43
<i>Creating an Elliptical BSDF property</i>	43
<i>Applying an elliptical BSDF surface property to a surface</i>	44
Using TracePro Diffraction Gratings	46
<i>Using Diffraction Gratings in TracePro</i>	46
<i>Ray-tracing a Grating Surface Property</i>	49
Example Using Reverse Ray Tracing	51
<i>Specifying reverse rays</i>	52
Example Using Luminance/Radiance Maps	65
Example Using Photorealistic Rendering	67

What is TracePro?

TracePro is a ray tracing program for optical analysis of solid models. TracePro traces rays using “Generalized Ray Tracing”. This technique allows you to launch rays into a model without making any assumptions as to the order in which objects and surfaces will be intersected. At each intersection, individual rays can be subject to absorption, reflection, refraction, diffraction and scatter.

As the rays propagate along different paths throughout the solid model, TracePro keeps track of the optical flux associated with each ray. TracePro fully accounts for the absorption, specular reflection and refraction, diffraction, and the scattering of light.

The best way to use TracePro is to follow the outline below for starting a new TracePro project. These steps will be discussed in greater depth in the following sections.

1. Chapter 2, 'Creating a Solid Model' - The first step is to build or import a geometrical model representing the system you wish to analyze. If you are building a model from scratch, the geometry usually starts simply and eventually grows to a very accurate and detailed representation of your system over the life of the project.
2. Chapter 3, 'Defining Properties' - Material and surface properties representing desired attributes such as reflection, refraction, absorption and scatter are defined for your geometrical model. If appropriate, you can use properties already defined in the TracePro property databases, or you can tailor properties to satisfy your specific needs.
3. Chapter 4, 'Applying Properties' - Once properties are defined, you can apply the properties onto the appropriate objects and surfaces in your model.
4. Chapter 5, 'Ray Tracing and Optimization' - Rays are traced through the model by defining ray starting points as either grid sources, surface sources or imported sources. How the rays are launched into the model, and which raytrace parameters are invoked is usually closely tied to the analyses you wish to do on the system after the fact.
5. Chapter 6, 'Analysis' - A variety of analysis options are available to determine the location, extent and distribution of the resultant flux from the raytrace. Analysis options are extensive and include irradiance, illuminance, candela and volume flux maps as well as detailed ray history information that can be saved to data files for post-processing.

If you are new to TracePro, you will find that the user interface is easy to learn and you should be able to master each of these steps in very short order.

Why Solid Modeling?

Solid modeling is a technique for constructing computer models of geometrical systems using “solid” pieces of virtual material, just as you build real hardware out of real material. By using solid modeling you can be confident that you are modeling something that is physically buildable and you obtain a consistency of modeling that avoids many modeling errors. Solid modeling is gaining wide

acceptance among mechanical designers. It is used in many finite element analysis (FEA) programs and mechanical computer aided design (CAD) programs.

Using solid modeling makes sense for an optical analysis program for several reasons:

1. It uses established technology for modeling physical systems, including Non-Uniform Rational B-Spline (NURBS) surfaces.
2. It shares or exchanges data with other design and analysis programs.
3. It connects associated material properties, such as index of refraction, to solid objects in the model.
4. It prevents some of the most common modeling errors, such as making a solid cube with only five sides.

How Does TracePro Implement Solid Modeling?

TracePro is based on a solid modeling engine. Using this modeler, TracePro can exchange data with most other based CAD and analysis programs via IGES, STEP and other CAD formats using built-in translators. TracePro can also import lens design files from popular lens design programs.

Any entities that you create in TracePro are referred to collectively as a “model.” Contained in this model are the individual pieces of solid geometry that are called “objects.” By using a solid modeling approach, TracePro requires that all solid objects must be bounded by surfaces. Objects can be defined within TracePro, or they can be defined elsewhere (as in a CAD program) and imported into TracePro. Objects within the TracePro solid model can be manipulated in a number of different ways including the action of combining two or more objects into a single object so that the only surfaces the object now has, are the “bounding” or “outer” surfaces of the object.

Why Monte Carlo Ray Tracing?

In TracePro modeling, the Monte Carlo method is used to simulate the scattering and diffraction of light, and to sample of the distributions of rays emanating from light sources. In the absence of scattering and diffraction processes, light travels in discrete directions which are exactly modeled by ray tracing. However, when light scatters from a surface, it produces a continuous distribution of light. One could in principle calculate the propagation of light exactly by propagating this distribution to the next surface, then cascade this distribution with the distribution produced by the next surface, and so on, until the irradiance in the light field is so low that it can be neglected. To model light propagation in this way can require an enormously complicated computer program.

The Monte Carlo method is a technique for computing the outcome of random processes. It is used for modeling quantum-mechanical processes that can only be described by their statistics. Monte Carlo as applied to the propagation of light can also be described as a technique for numerical integration. As such it is used when conventional numerical integration techniques cannot be used because the problem to be solved is not amenable to those techniques.

In Monte Carlo ray tracing, scattering and diffraction are treated as random processes. Instead of propagating a distribution of light, discrete samples of the distribution, or rays, are propagated. The samples are randomly chosen, using the

scattering distribution as a probability density. This allows the well-developed techniques of ray tracing to be used to model scattering.

In “brute force” Monte Carlo ray tracing, the directions of rays are chosen randomly, and a reliable answer is obtained by tracing a very large number of rays. TracePro makes use of variance reduction techniques to reduce the number of rays required to get a reliable result.

The TracePro Graphical User Interface

TracePro is designed to provide an easy-to-use graphical interface for viewing the model; adding solid objects to it; and applying material properties, surface properties, and source properties. There are many toolbar buttons for quick access to commands, and a pop-up menu is available with frequently-used commands. The pop-up menu opens by clicking the right-hand mouse button.

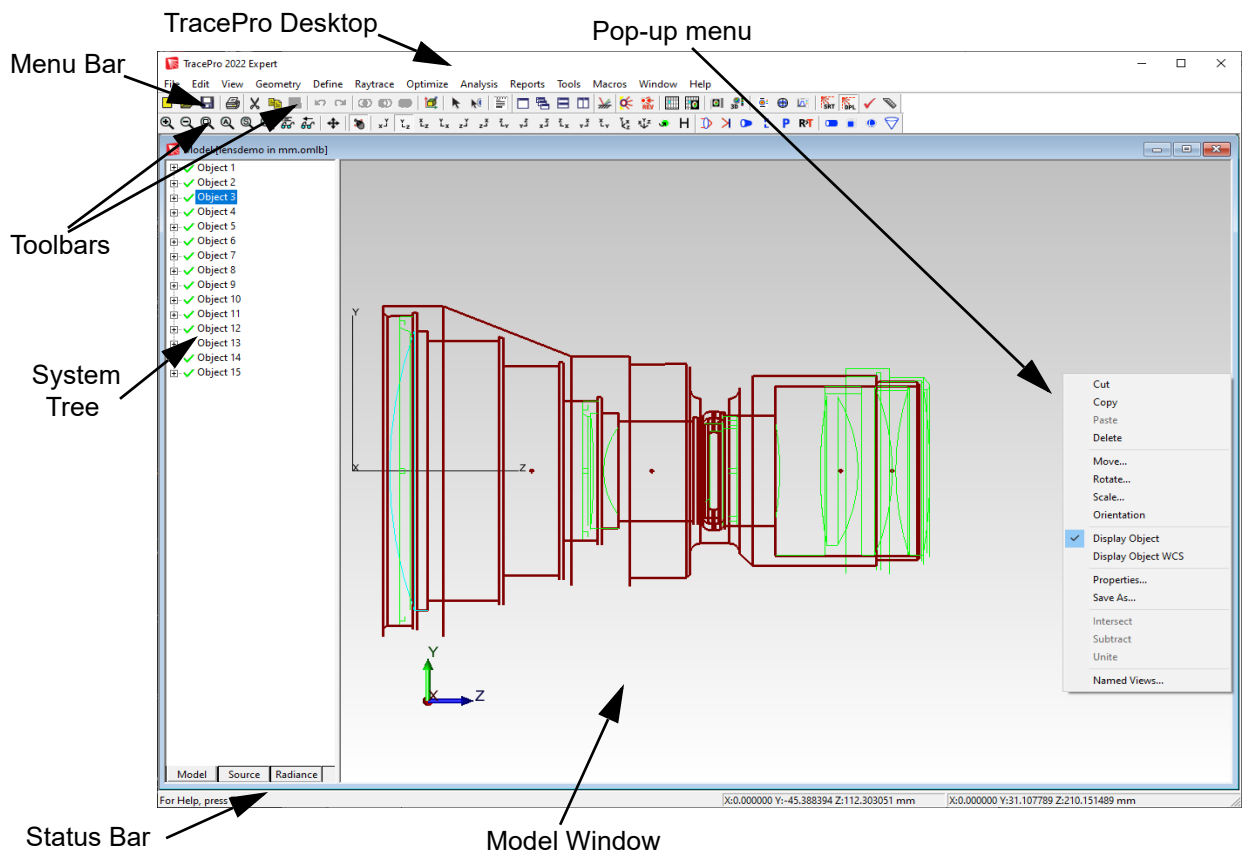

FIGURE 1.1 - TracePro desktop and window features.

Toolbars

The toolbar buttons allow for quick access to many of the features in TracePro. The toolbars are dockable and can be moved to different locations if desired. The toolbar settings can be controlled at **View|Toolbars**.

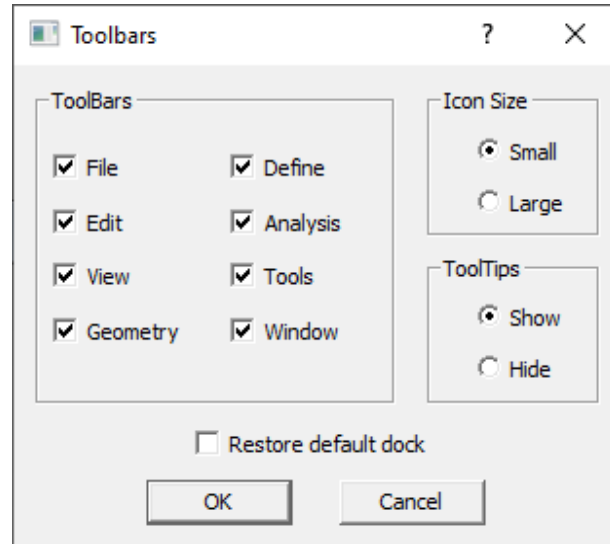

FIGURE 1.2 - Toolbar settings

Model Window

The window in which geometry is displayed is the Model Window. When you open a TracePro file (referred to as a *model*) a Model Window opens with the geometry displayed as a silhouette in the side view. This is the y-z view, with the y axis pointing up and the z axis pointing to the right, a common convention in optics.

The **View|Profile** commands (**YX**, **ZY**, **ZX**, **XY**, **XZ** and **YZ**) let you choose the right orthogonal view.

You can zoom in and out using the mouse wheel, and you can also Pan, Zoom and Orbit using the mouse and Ctrl or Shift Keys.

The functions and key combinations are:

View Pan	is performed by pressing Ctrl key and the Right mouse button
View Rotate Orbit	is performed by pressing the Shift key and the Right mouse button
View Zoom Cursor	is performed by pressing the Ctrl key and pressing the Middle mouse button (or pressing the mouse wheel)
View Zoom Window	is performed by pressing the Shift key and pressing the Middle mouse button (or pressing the mouse wheel)

Note: Press the Key first, then the Mouse button. You will see the appropriate toolbar item activate.

Multiple Models in Multiple Views

TracePro has a multiple document/multiple view interface. This means that you can have many models or files open at one time, and you can also have many views of each model open at one time.

To open multiple views of the same model, simply select the desired model window by clicking on it with the mouse, then select the **Window | New Window** menu item multiple times. You can also do this quickly by pressing the *New Window* toolbar button multiple times.



FIGURE 1.3 - Window control Toolbar buttons: A) New Window, B) Cascade Windows, C) Tile Windows Horizontally, D) Tile Windows Vertically

Once multiple model windows have been created, you can view your model independently in each of the views. Windows can be cascaded, tiled, and minimized using the usual Windows controls, available either on the **Window** menu or the toolbar shown in Figure 1.3.

If you would like different models open at the same time, simply open them from the **File | Open...** menu item or use the **Open** toolbar button. The desired model will be opened in a new window. Once the desired model windows are open, you can manipulate the models and model windows independently, as in Figure 1.4.

It is important to remember that any action you take (i.e. tracing rays, applying properties,...etc.) will be applied to the currently active model from the selected window. When working with multiple windows in TracePro, you must remember to select the desired model window before choosing the action that is to be performed.

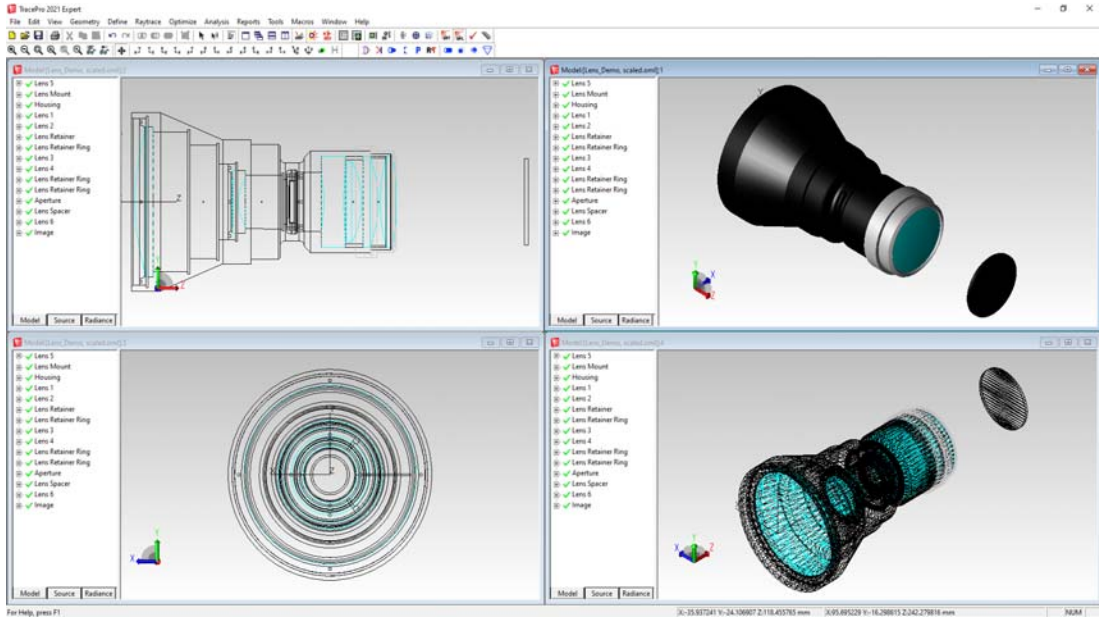

FIGURE 1.4 - A single model viewed in different orientations in multiple model windows. The image also includes a Rendered view (upper right), and Wireframe view (lower right).

System Tree Window

The System Tree Window at the side of the Model Window allows you to view and manage various system items in hierarchical tree formats. There are three tabs at the bottom of the System Tree Window describing the items that can be displayed:

- The Model tab reveals the Model Tree and allows you to manage the objects and surfaces of the model
- The Source tab reveals the Source Tree and allows you to manage the sources in the model (see page 5.3)
- The Luminance/Radiance tab reveals the Luminance/Radiance Tree and allows you to manage the setup of Luminance/Radiance calculations (see page 6.18). Note that the wording of the **Luminance/Radiance** tab in the System Tree window is automatically set to either **Luminance** or **Radiance** by TracePro depending on the analysis units of the model (see page 5.43).

If the System Tree Window is not already visible, you can reveal it by clicking and pulling on the splitter bar on the side of the Model Window with the mouse. The default position for the splitter window is on the left side of the model window, but this can be changed on the View page in the **View|Options** dialog box.

The splitter bar is illustrated in Figure 1.5 in its default location. You can also display the Splitter Cursor by selecting the **Window|Split** menu.

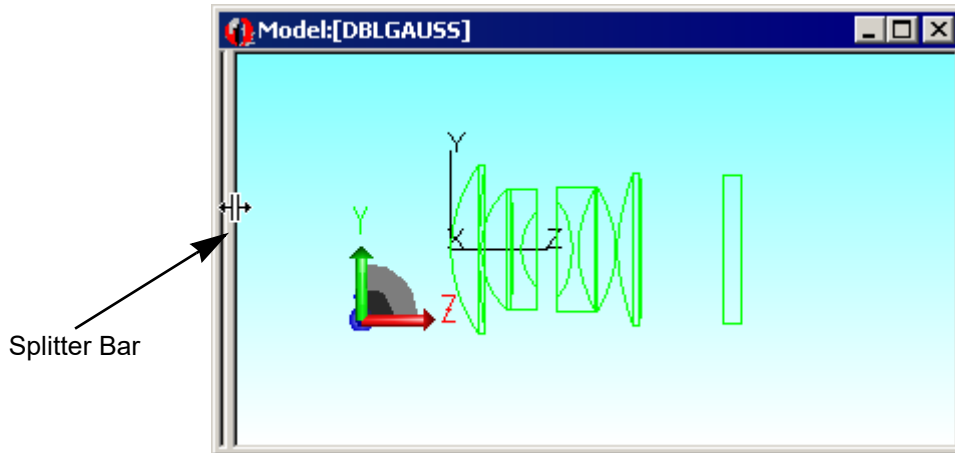

FIGURE 1.5 - The System Tree Splitter Bar at the default location

After you open the System Tree split window, as in Figure 1.6, you can look for a “+” character to indicate that you can “expand” an object to display its surfaces. Further, you can use the System Tree to select surfaces with a + character to expand.

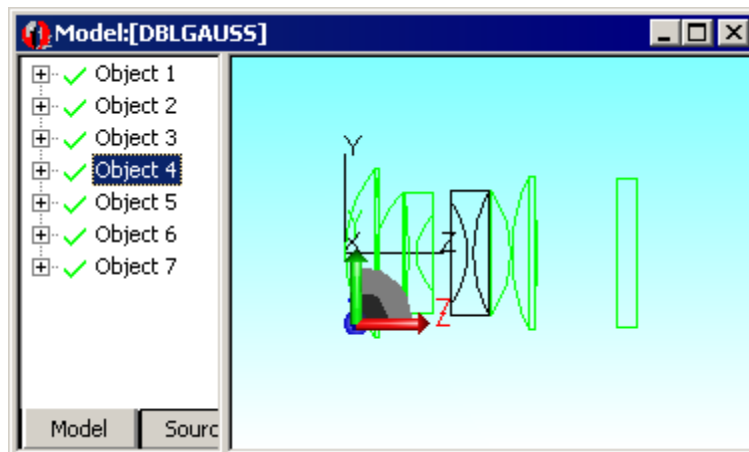

FIGURE 1.6 - The System Tree made visible by moving the splitter bar

If you select an object or surface in the System Tree, that object or surface changes color to black to indicate the selection. Similarly, if you select an object or

surface in the Model Window, you can see the selection as highlighted in the System Tree.

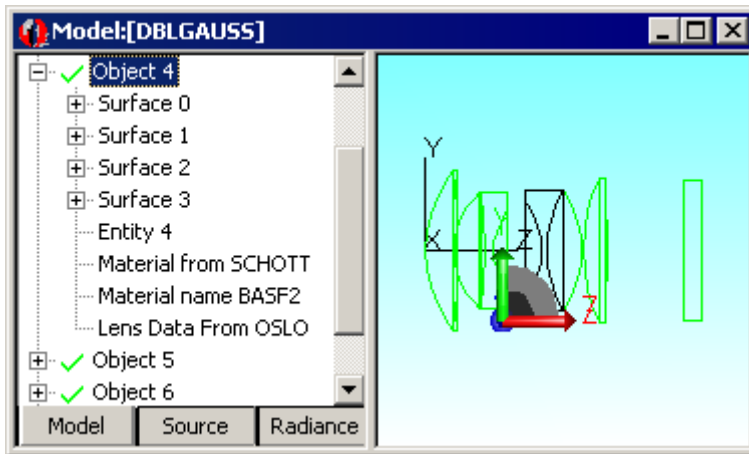

FIGURE 1.7 - The System Tree window after expanding Object 4

After Object 4 is expanded, you can see:

- Individual Surfaces
- Material property Catalog
- Material property Name

Selecting a surface in the System Tree highlights it in the Model Window. If you select and expand a surface on the system tree, you can also see the:

- Surface property
- Optional source property.

It is recommended that you leave the system tree view open. An open system tree view helps you:

- Visualize your work
- Select surfaces and objects

System Tree Selection

The System Tree includes additional surface type information for spline surfaces.

In addition, property information can be accessed directly by double clicking on the data items. Figure 1.8 shows a typical object with expanded tree items.

Double clicking on either of the Material items will open the **Apply | Properties** dialog and display the **Material** page. Double clicking on one of the Surface items will result in the **Surface** page being displayed. Clicking on a non-property items, like the Entity number, will be ignored.

Each object is preceded by a Green Check or Red X. Clicking on this flag will enable or disable the “Raytrace Flag” for the raytrace. If the item has the Red X, the Raytrace Flag is off and the object will be removed from the raytrace.

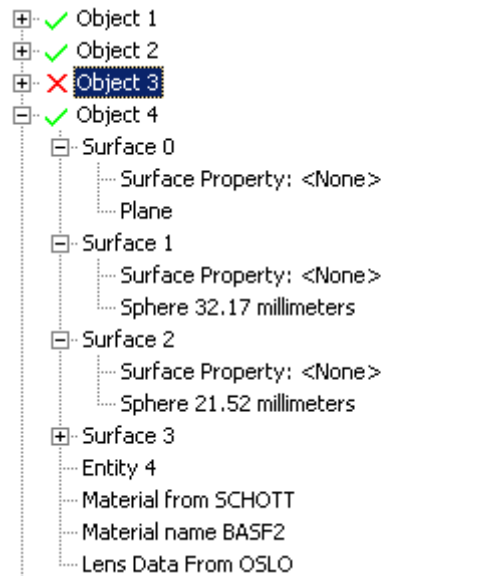

FIGURE 1.8 - System Tree

Re-arranging the System Tree

You can re-arrange the system tree by changing the order of objects or by making groups of objects. To make a new group, right-click on the tree in location where you would like the group, and select **New Object Group** from the pop-up menu.

To move a selection of objects and/or groups, either to a new group or to a new location in the System Tree, first right-click and select **Enable Drag/Drop**. Then select the objects/groups you wish to move, and drag the selection to the new location in the tree. When you are done re-arranging the tree, you should unselect **Enable Drag/Drop** in order to avoid accidentally re-arranging the tree while doing other operations.

Context Sensitive Menus

TracePro provides context sensitive menus based on the active window. The Model Window is the most common window displayed and has its own main menu (File, Edit, View, etc.). The main menu will change when Property Editors or Analysis windows are opened and activated. These windows will be described later in the manual but it is important to note that the active window controls the menubar. To return to a specific menu, click in the desired window or select from the list under the **Window** menu.

Model Window Popup Menus

In addition to the main menu, each window may have one or more Popup menus. These menus are displayed by right-clicking with the mouse.

Figure 1.9 shows the three Model window menus which vary based on the state of the current selection. See “Selecting Objects and Surfaces” on page 1.11.

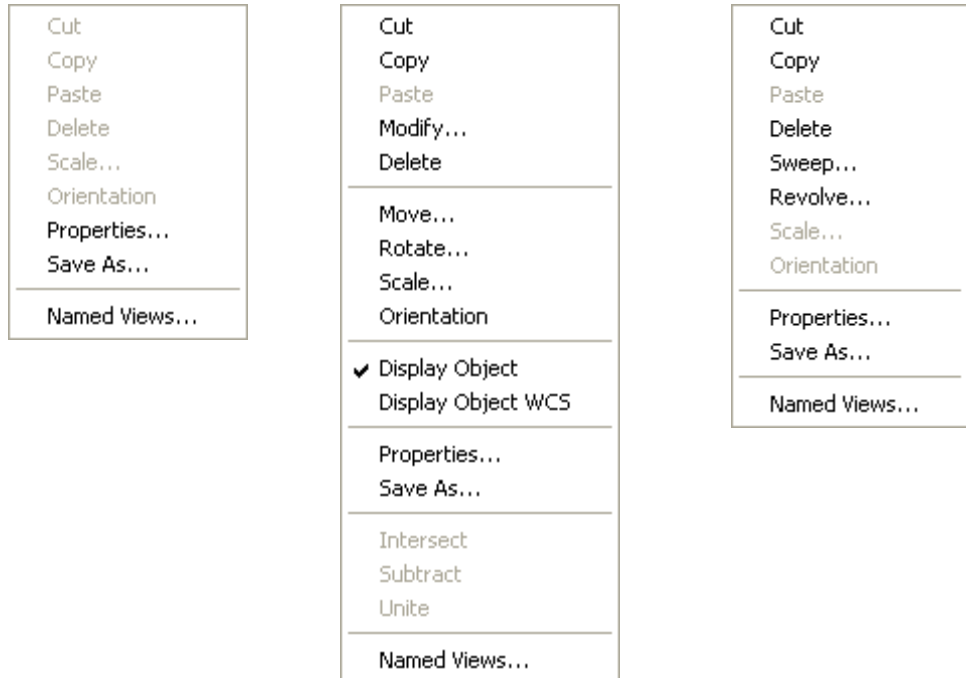

FIGURE 1.9 - Model window popup menus for No Selection, Object Selection, Surface Selection.

System Tree Popup Menus

Figure 1.10 shows the two System tree menus which vary based on the item clicked.

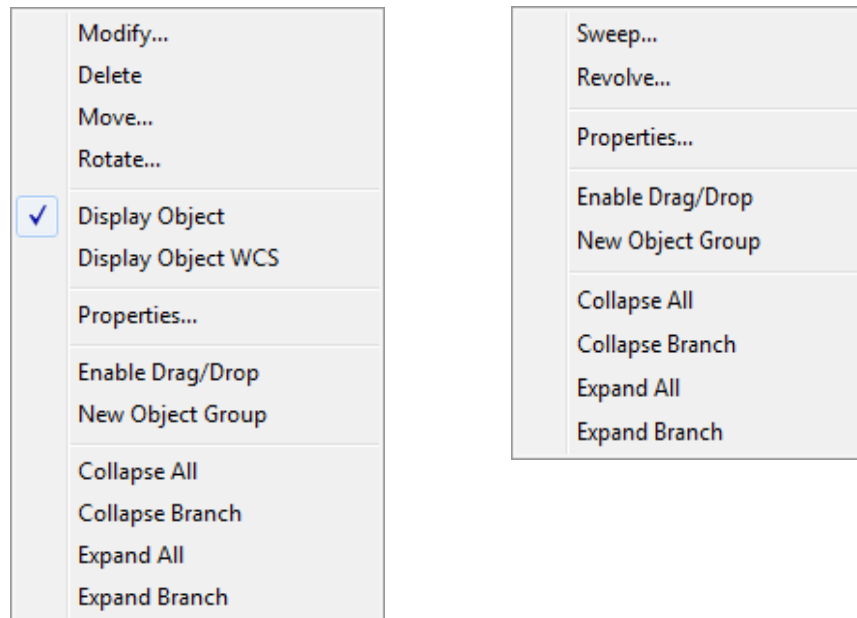

FIGURE 1.10 - System tree menus for Object and Surface Selection.

User Defaults

User Defaults store the initial dialog entries into a file named *tpdefs.ini*. Raytrace and Analysis dialogs contain the *Set Defaults* button used to store the dialog data. Pressing *Set Defaults* is equivalent to pressing the *Apply* button. Once the defaults are updated, TracePro will use the new values the next time the program is started. To return to the factory defaults, select **View|Options|Reset Defaults**, and reset any or all default values, as desired.

Objects and Surfaces

Changing the Names

In order to better organize your model, you should apply names to objects and surfaces to replace the default names like “Object 1” and “Surface 1.” As with renaming most items in the Microsoft Windows environment, simply select the default name in the system tree with one click and click it again (or press **F2** on your keyboard) to enable name editing.

To change the default name “Object 1” to “First Lens,” for example, select Object 1 in the System Tree and click it again. As you click the words “Object 1” a second time, the name is highlighted and you enter name editing mode. Type in the new name to replace the default one. The name is not a unique identifier—be careful! Any number of objects or surfaces can be given the same name.

When an object is created from a TracePro dialog box, an entry is provided to set the name of the object. A default name is provided based on the type of object created and the number of objects of the given type plus one. For example the first block entered would be named “Block 1”. You can enter any name you wish and names do not have to be unique.

Selecting Objects and Surfaces

Via the System Tree

To select an object via the System Tree, simply click on the name of the object. To choose a particular surface in your model, first make sure that the appropriate object is expanded (see the section “System Tree Window” on page 1.6), and then click on the desired surface name. Remember that the names in the System Tree can be changed and that when you choose a surface or object in the System Tree, the corresponding item is highlighted in the Model Window. An edge cannot be selected from the System Tree.

You can select several objects by extending the selection with the Shift or Ctrl keys. To use the Shift key, select the first item and then select the second item while holding down the Shift key (this is known as a Shift Select). All of the objects between the first and second selections will be added to the current selection set. If you use the Ctrl key with the second selection, only the first and second items will be added. You can use the Ctrl Select method to add several items to the selection set.

Note: The Shift Select method will work only when selecting the same type of item. If the first selection is an Object and the Shift selection is a surface, only the surface item will be selected.

Via the Model Window



To select an object, first press the Select Object toolbar button or select the **Edi t | Sel ect Obj ect** menu item, then click on the object in the Model Window. You can also use the selection tool in rubberband mode. Click the mouse button down on one corner of a region, drag the cursor to the opposite corner and release, and all the objects in the region are selected. Selected objects are highlighted.



To select a surface, first press the Select Surface toolbar button or select the **Edi t | Sel ect Surface** menu item, then click on the surface. You can also use the selection tool in rubberband mode. Click the mouse button down on one corner of a region, drag the cursor to the opposite corner and release, and all the surfaces in the region are selected. Selected surfaces are highlighted in the highlight color.

The rubberband selection tool has two modes:

- **Drag left to right:** Any surface that has any part inside the rectangle is included in the selection.
- **Drag right to left:** Any surface that is completely enclosed inside the rectangle is included in the selection. This can also be accomplished by **Shift-drag-left-to-right**.

Advanced Selection Dialog

Surfaces and Objects can also be selected by type and property using the Advanced Selection Dialog. For example, if the mirrors in a TracePro Model currently have the Surface Property “Perfect Mirror” applied, but the accuracy of the model now necessitates that a more detailed property be substituted that includes some scatter and absorption, the Advanced Selection feature can be used to select all surfaces in the model that are currently have “Perfect Mirror” applied, so they can all be changed to the new mirror property in one step.

Select **Edi t | Sel ect | Advanced** to open the Advanced Selection dialog.

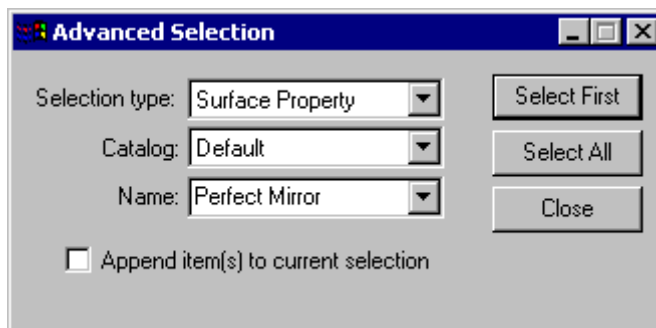

FIGURE 1.11 - Advanced Selection Dialog.

The dialog has the following options and functions.

Selection Type – The selection types are as follows:

- Material Property
- Surface Property
- Bulk Scattering Property
- Gradient Index Property

- RepTile Property
- Surface Source
- TracePro Lens (geometry recognized as originating from Insert Lens Element dialog)
- TracePro Reflector (geometry recognized as originating from Insert Reflector dialog)
- Class and User data

Catalog – the name of the Property Catalog (corresponding to the Property Editor)

Name - the Property Name (corresponding to the Property Editor)

Select First – This button selects only the first object and/or surface meeting the criteria of the Selection Type, Catalog, and Name fields. Once Select First has been activated, the button changes to **Select Next**, and can be used multiple times to select subsequent objects and/or surfaces that meet the selection criteria.

Select All – selects all objects and/or surfaces meeting the criteria of the Selection Type, Catalog, and Name fields

Close – closes the Advanced Selection dialog

Append item(s) to current selection – With this box checked, the action of the Select First or Select All button will be to append the new selection to any previous selection of objects and/or surfaces. If this box is left unchecked, the action of the Select First or Select All button will be to replace any previous selection of objects and/or surfaces.

Moving Objects and Other Manipulations

Manipulating objects starts by making a selection as described above. To add more objects to the selection, hold down the Ctrl key on the keyboard and click the objects with the mouse.



To move the selected object(s), press the Translate toolbar button or select the **Edi t | Obj ect | Transl ate** menu item, and simply drag them to a new location using the mouse while pressing the left mouse button.

You can drag a copy of the selection by holding down the Ctrl key while you drag with the mouse. These are all standard Windows editing features.

You can also move the objects to a numerically precise location by using the **Edi t | Obj ect | Move** dialog box, and rotate objects using the **Edi t | Obj ect | Rotate** dialog box.

You can Cut, Copy, and Paste solid objects using the standard Windows editing controls.

Finally, you can create arrays of objects by clicking the Copy button in the **Edi t | Obj ect | Move** and **Edi t | Obj ect | Rotate** dialog boxes.

Interactive Viewing and Editing

Using the controls on the View and Edit menus, you control the view using the mouse and move and rotate objects or groups of objects. For example, you can zoom in or out, zoom to a rectangle drawn with the mouse, and rotate the view.

The coordinates of the mouse are always displayed on the status bar at the bottom of the TracePro application window. The set of coordinates on the right shows the current cursor position. The values shown on the left display the coordinates of the last mouse click. See “Changing the Model View” on page 2.50.

Normal and Up Vectors

TracePro uses a three-dimensional coordinate system with a global origin and X, Y, Z vectors to indicate directions. Often a plane must be defined to establish how the model will be viewed or how data will be displayed. The orientation of this plane is defined in terms of two direction vectors, the Normal and Up vectors.

The Normal vector is simply the direction Normal to the plane. You can think of planes as your computer screen or a piece of paper in a book laid out flat on a table. The direction perpendicular to the screen or paper is the normal vector.

The Up vector generally is used to arbitrarily reference the direction which is considered up or the Y direction. A rectangular plane, for example, has a height and a width which differ in size. Defining the Up vector along the long edge would define the height to be the long dimension and the width to be the short dimension. The reverse is equally valid.

TracePro does not make any assumptions about how the model is defined in space and thus requires you to intervene by defining these vectors. For optical engineers and lens designers the Image Plane would have a Normal vector equal to X=0, Y=0, and Z=1 with an Up vector or X=0, Y=1, and Z=0. Lighting designers who typically consider lights above the target often think of this target plane to correspond to a Normal vector of X=0, Y=-1, and Z=0 with an Up vector defining the direction of the zero azimuthal angle in the XZ plane depending on the Model orientation.

The Normal and Up Vectors are defined as Unit Vectors that TracePro will normalize to have a unit length of 1.0. Each value is scaled as shown

$$t = \sqrt{X^2 + Y^2 + Z^2} \quad (1.1)$$

$$X_n = \frac{X}{t} \quad (1.2)$$

$$Y_n = \frac{Y}{t} \quad (1.3)$$

$$Z_n = \frac{Z}{t} \quad (1.4)$$

where t is the scaling factor. The normalized values of X, Y and Z are given by X_n , Y_n , and Z_n .

The concept of planes oriented with the Normal and Up vectors provides a flexible environment to build and analyze models but may take some practice to become comfortable with its use in TracePro.

Modeling Properties

TracePro includes a database of property data for modeling optical and mechanical material properties and surface properties. In addition to the data that is already available within TracePro, you can customize properties by entering measured data.

- Object properties are applied to objects and affect the entire volume of the object. These include the material property which specifies the index of refraction and absorption coefficient of the bulk material, temperature, bulk scattering, and fluorescence.
- Surfaces define the boundaries of objects. The surface properties specify parameters that apply to a surface of an object such as the surface property (absorptance, specular reflectance, specular transmittance, BRDF and BTDF), surface source property, and surface temperature.
- The surface source property specifies how a surface emits light. Other properties are used to identify special characteristics of a surface or object.

The details of how these properties are defined and how they can be changed are described in Chapter 3.

Applying Properties

In order for a TracePro model to behave properly when doing any type of ray tracing or analyses with your model, you will need to apply optical, mechanical and source properties to the appropriate objects and surfaces. A good way to get a quick preview of how properties are applied is to click on the **Define | Apply Properties** menu item. The Apply Properties dialog box will open with multiple panes accessible by clicking on the list at the left. In Chapter 4 you will learn how to apply these properties.

Modeless Dialog Boxes

Many TracePro operations are performed using dialog boxes. Many TracePro dialog boxes are *modeless*. A modeless dialog box means that you can do other tasks while the dialog box is open.

Modeless dialog boxes let you have several dialog boxes open at one time. For example, if you open the *Apply Properties* dialog box, a modeless dialog box, you can then press the *Select Surface* toolbar button. You can then go back to the *Apply Properties* dialog box and select the *Surface Properties* tab.

Now go to the Model window and click a surface to which you plan to apply surface properties. You can go back to the dialog box, select the properties to apply, then press the Apply button to apply them to the surface.

Expression Evaluator

In many dialog boxes within TracePro, you will encounter numerical data entry fields that have a yellow background color. This color indicates that the field has a built-in expression evaluator. (See “Background colors” on page 2.58.) You can enter a mathematical expression in these fields that evaluates to the number you desire. Mathematical operators that you can use include +, -, *, /, and trigonometric functions. In order for the expression evaluator to interpret the field entry as a mathematical expression, the expression must start with the equal sign

(=). The result of the expression evaluator will not be shown in the field box, but the appropriate value will be used in the model in place of the expression.

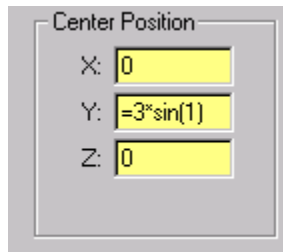

FIGURE 1.12 - Portion of a dialog box showing an example of the Expression Evaluator. The Expression Evaluator can be used in any numerical data entry field which has a yellow (default) background.

For a complete list of valid input for expression see Table 1.1

Table 1.1: Expression Evaluator Commands

	Name	Example	Result
Operators			
U	Unary Minus	=-6	-6
+	Add	=12 + 2	14
-	Subtract	=12 - 2	10
*	Multiply	=12 * 2	24
/	Divide	= 12 / 2	6
^	Power	= 12 ^ 2	144
%	Modulus	=12%6	0
		=12%5	2
Constants			
PI	pi	=PI	3.14159
E	e	=E	2.71828
Functions			
SIN	Sin (Radians)	=sin(PI/4)	0.707107
COS	Cosine (Radians)	=cos(PI/4)	0.707107
TAN	Tangent (Radians)	=tan(PI/4)	1.0
SIND	Sin (Degrees)	=sind(45)	0.707107
COSD	Cosine (Degrees)	=cosd(45)	0.707107
TAND	Tangent (Degrees)	=tand(45)	1.0
ASIN	ArcSin (Radians)	=asin(0.707107)	0.785398
ACOS	ArcCos (Radians)	=acos(0.707107)	0.785398
ATAN	ArcTan (Radians)	=atan(1)	0.785398

Table 1.1: Expression Evaluator Commands

ASIND	ArcSin (Degrees)	=asind(0.707107)	45
ACOSD	ArcCos (Degrees)	=acosd(0.707107)	45
ATAND	ArcTan (Degrees)	=atand(1)	45
ABS	Absolute Value	=abs(-12)	12
MAX	Maximum Value	=max(1.2,3.4)	3.4
MIN	Minimum Value	=min(1.2,3.4)	1.2
LOG	Log base 10	=log(12.3)	1.08991
LN	Natural Log	=ln(12.3)	2.5096
EXP	Exponential	=exp(2.03)	7.61409
SQRT	Square Root	=sqrt(144)	12
RAN	Random Number 0.0 - 1.0	=ran	.3801
STEP	Step Function	=step(2)	1
DELTA	Delta Function	=delta(-2)	0
SQRWV	Square Wave (x, period, phase)	=sqrwv(2,3,1)	1

Context Sensitive OnLine Help



TracePro has context sensitive online help. Help is available on features in the program by using the Help toolbar button, or pressing the Shift + F1 key. This is a standard Windows feature. Press the Help Button, then select the menu item or dialog box, or press the toolbar button for which you want help. You can also press F1 while the cursor is highlighting a menu item to get help regarding that selection.

There is also reference material available in TracePro. Use the **Hel p Topi cs** menu or **Macro Reference** menu to obtain reference material.

Command Line Arguments

TracePro is normally started from Windows like any other application. However, TracePro can also be started from the command line, Run dialog or have command line options appended to a TracePro shortcut in Windows. These methods are described within the Windows documentation.

The following lists the syntax and parameters for the TracePro command line options.

```
TracePro
  [/m] [/nologo] [/SNxxxx]
  [scheme_file]
  ["(scheme command)"]
  [/d] [/h heap_size] [/tnn]
```

Example:

```
TracePro /nologo g:/test.scm "(test2 123)"
```

The arguments are as follows:

- Setting **/m** will start TracePro in a minimized mode.
- Setting **/nologo** will inhibit the display of the TracePro Splash Screen.
- Setting **/SNxxxx** will make "xxxx" the DDE service name which is TRACEPRO by default. This is used so multiple instances of TracePro can be accessed by DDE.
- **Standard** **Expert** The **scheme_file** is an ASCII file ending in the SCM extension which contains the TracePro macro commands to load and optionally execute.
- **Standard** **Expert** The **scheme command** is any set of valid macro commands with or without optional arguments contained between two double quotes. The left and right parentheses are required. The command can be a function contained in a file loaded from the command line or from the Auto Load macro.
- **Standard** **Expert** Setting **/d** suppresses the Auto Load macro defined in the **View|Customize** dialog.
- **Standard** **Expert** Setting **/h** specifies scheme heap size in kilobytes. The default is 32768 for x86 systems and 16384 for x64 systems. You may need to increase this if you are loading large Scheme programs.
- Setting **/t** specifies the maximum number of threads TracePro will use. For example, to specify no more than 2 threads, use **/t2**.

Note: the forward slash, "/", is equivalent to the hyphen, "-", to delineate command line arguments. The forward slash is equivalent to the backward slash, "\", when entering the location and path for a file.

```
TracePro /nologo g:/test.scm "(test2 123)"
```

is equivalent to

```
TracePro -nologo g:\test.scm "(test2 123)"
```

Using a Language other than English

TracePro can be used in any of several languages other than English, including Chinese (simplified) Chinese (traditional), Japanese, Korean, Italian, and Spanish. After you install TracePro and start it for the first time, the language will be set to English. To set it to another language, Select **Tools | Change Language** and select the language you wish to use. You must close TracePro and re-open it to see the menus in the new language. On-line help is in English regardless of the language setting.

Introduction to Solid Modeling

Solid modeling is a technique for constructing computer models using “solid” pieces of virtual material, just as you build real hardware out of real material. In a solid model, objects are three dimensional entities defined to be bounded by surfaces. By using solid modeling, you inherently obtain a consistency of modeling that avoids many modeling errors. You can be confident that you are modeling something that is physically realizable.

There are many ways to define and manipulate objects in solid modeling; it is a field in its own right. TracePro offers several ways to create and manipulate solid objects:

- Import data from a solid modeling program,
- Import data from a lens design program - TracePro creates a solid model automatically,
- Create primitive solid objects including blocks, cylinders and cones, spheres, tori, and thin sheets,
- Create solid objects needed for optomechanical systems including optical elements, reflectors and concentrators, Fresnel lenses, tubes, and baffle vanes,
- Create complex solid objects from primitive solids using Boolean operators: Intersect, Subtract, and Unite, and
- Modify solid objects by using the Sweep and Revolve commands.

Model Units

TracePro Models may be constructed and viewed in several units of measure. The dialogs described in this chapter and throughout the manual refer to Model Units. The Model Units are set as a preference and stored with the Model data in the TracePro OML file. See “General” on page 2.57.

Internally TracePro stores geometry data and performs calculations in units of millimeters (mm). The Model Units are used to scale dialog inputs and display outputs from millimeters to the desired dimensional units.

Position and Rotation

Many of the dialogs provide options for position and rotation. During construction TracePro will build the object at the global origin and change the orientation (position and rotation) based on the input data. An object’s position is set by the object’s Working Coordinate System (WCS) from the global origin. TracePro provides an option to display the object’s WCS which may be centered or coincident with a surface vertex. See “Display Object WCS” on page 2.54. Rotation is performed relative to the object WCS using Euler Angles. This is similar to rotating surfaces in lens design programs. The rotations are performed first about the x-axis, then about the y-axis and then about the z-axis. The resulting orientation is not necessarily unique. For instance rotating an object by 90 degrees about the x-axis and then the z-axis will be the same as rotating the

object by 90 degrees about the y-axis and then performing a second rotation of 90 degrees about the x-axis. A translation of the object's center position is performed after the rotations.

Defining Primitive Solid Objects

Simple or primitive solid objects are created in TracePro using the **Geometry | Primitive Solid** menu item and the dialog box it opens. It is a tabbed dialog box, with tabs for Block, Cylinder/Cone, Torus, Sphere, and Thin Sheet.

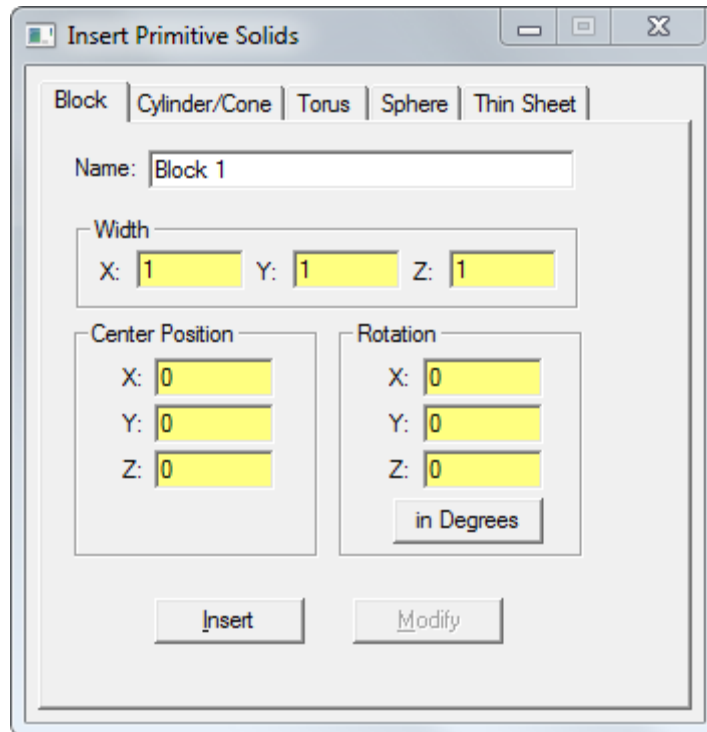

FIGURE 2.1 - Insert Primitive Solid dialog box

The Block, Cylinder/Cone and Torus tabs let you specify rotation angles for the solid. Each of these angles are rotations about the coordinate axes. When you select the Insert button, the solid is created at the origin, then rotated first about the x-axis, then about the y-axis, then about the z-axis, and finally moved to the position you have entered.

Many of the objects created within TracePro can be modified with the same dialog that created them--note the *Modify* button in Figure 2.1. You can select an existing primitive object and then use the **Geometry | Primitive Solid** dialog box to access and change the data by pressing the *Modify* button. Note that the *Modify* button will be disabled if you don't have an appropriate primitive solid selected in the model window.

Block

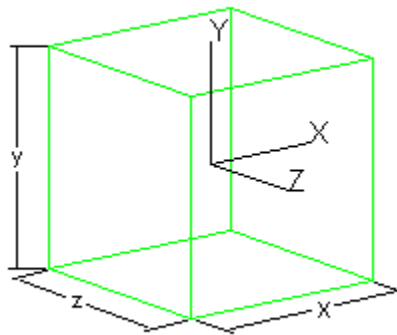

FIGURE 2.2 - Block primitive object

To create a block:

1. Select the Block tab of the **I n s e r t P r i m i t i v e S o l i d s** dialog box.
2. Enter the X, Y, Z width dimensions of the block.
3. Enter the X, Y, Z coordinates of the center of the block under Center Position.
4. If you wish to rotate the block, enter the X, Y, Z coordinate rotation angles.
5. Press the *I n s e r t* button to create the block.

If it is not visible in the current view, it is either too small to be seen, or it is outside the view. You can either **Z o o m W i n d o w** (if it's too small), **Z o o m A l l** (if it's too large or outside the view) or **Z o o m S e l e c t i o n** to make it visible.

Cylinder/Cone

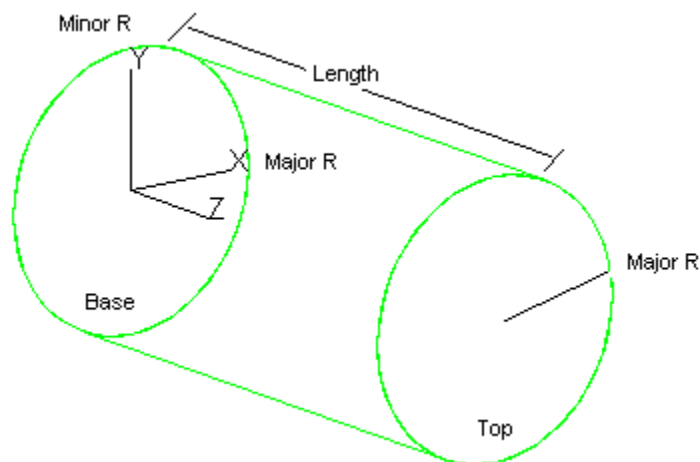

FIGURE 2.3 - Cylinder primitive object

To create a Cylinder:

1. Select the Cylinder/Cone tab of the **I n s e r t P r i m i t i v e S o l i d s** dialog box.
2. Select the Cylinder radio button.

3. Enter the X, Y, Z position of the base of the cylinder.
4. Enter the radius of the cylinder.
5. Enter the length of the cylinder.
6. If you wish to rotate the cylinder, enter the X, Y, Z coordinate rotation angles. An unrotated cylinder has its axis along the z-axis.
7. Press the *Insert* button to create the cylinder.

If you want an elliptical cylinder, check the Elliptical box and enter the Minor Radius.

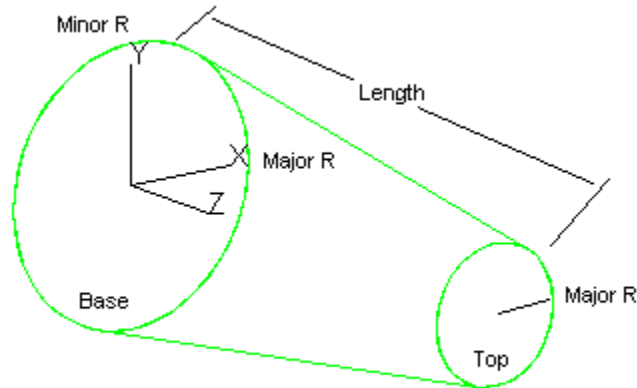

FIGURE 2.4 - Cone primitive object

To create a Cone:

1. Select the Cylinder/Cone tab of the **Insert Primitive Solids** dialog box.
2. Select the Cone radio button.
3. Enter the X, Y, Z position of the base of the cone.
4. Enter the base radius of the cone.
5. Enter the length of the cone.
6. Enter the top radius of the cone.
7. If you wish to rotate the cone, enter the X, Y, Z coordinate rotation angles. An unrotated cone has its axis along the z-axis.
8. Press the *Insert* button to create the cone.

If you want an elliptical cone, place a check mark in the Elliptical check box and enter the Base Minor Radius.

If it is not visible in the current view, it is either too small to be seen, or it is outside the view. You can either **Zoom Window** (if it's too small), **Zoom All** (if it's too large, too small, or outside the view) or **Zoom Selection** to make it visible.

Torus

A torus is a doughnut-shaped object. The major radius and the minor radius are indicated in Figure 2.5.

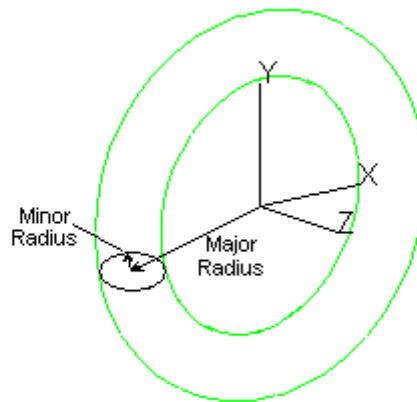

FIGURE 2.5 - Torus primitive object showing major and minor radii

To create a torus:

1. Select the Torus tab of the **Geometry|Primitive Solids** dialog box.
2. Enter the Major Radius and Minor Radius.
3. Enter the X, Y, Z coordinates of the center of the torus under Center Position.
4. If you wish to rotate the torus, enter the X, Y, Z coordinate rotation angles. An unrotated torus has its axis along the z-axis.
5. Click the *Insert* button to create the torus.

If it is not visible in the current view, it is too small to be seen or it is outside the view. You can select **Zoom Window** (if it's too small), **Zoom All** (if it's too large or outside the view) or **Zoom Selection** to make it visible.

Sphere

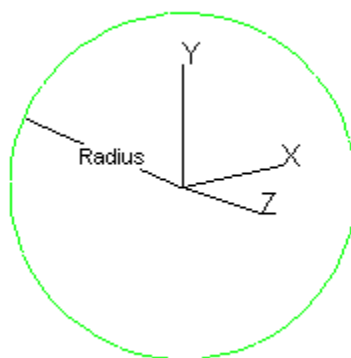

FIGURE 2.6 - Sphere primitive object

To create a sphere:

1. Select the Sphere tab of the **Geometry|Primitive Solids** dialog box.
2. Enter the radius of the sphere.

3. Enter the X, Y, Z coordinates of the center of the sphere under Center Position.
4. Click the *Insert* button to create the sphere.

If it is not visible in the current view, it is either too small to be seen, or it is outside the view. You can either select **Zoom Window** (if it's too small), **Zoom All** (if it's too large or outside the view) or **Zoom Selection** to make it visible.

Thin Sheet

A thin sheet is a solid object that has only one planar surface, and therefore no thickness or volume. It is useful for “catching rays” or as a starting plane for sweeping or revolving to create a true solid object. A thin sheet object may be defined with one of several possible boundary shapes:

- Circle
- Ellipse
- Rectangle
- Regular Polygon
- Irregular Polygon

Except for the irregular polygon, the boundary is specified by:

- Dimensions
- Center position
- Rotation angles

Creating a thin sheet object with no rotation angles results in a surface with its normal along the +Z direction, unless it's an irregular polygon. Any subsequent sweep or revolve operation along the surface normal will thus be in the +Z direction.

A regular polygon is one with equal length sides and equal angles, e.g. equilateral triangle, square, pentagon, hexagon, etc. The radius is measured from the center to a vertex, i.e. the radius of a circumscribed circle.

An irregular polygon is specified using at least three different positions consisting of X, Y and Z values. All the positions must lie in the same plane. X, Y and Z are in the current Model Units. The positions are connected by linear edges, with the last point being connected to the first point to close the boundary. This closed loop is then covered with a surface and made double-sided. **Note:** *The surface normal of an irregular polygon thin sheet follows the right-hand rule using the "curl" of the sequence of positions.*

Thin sheets may be used as reflectors or reference surfaces, and may be Extruded (Swept) or Revolved to create regular thick objects.

Thin sheets can also be used as “observation” surfaces available for viewing by an Irradiance Map as rays propagate through the model, such as reference planes within a lightpipe.

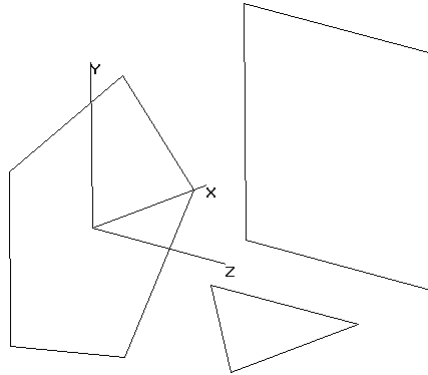

FIGURE 2.7 - Thin Sheet primitive objects

To create a new thin sheet, first select the **Primitive Solid** command from the **Geometry menu**. Then click on the **Thin Sheet** tab and enter the appropriate data. Finally, click Insert, and the **Thin Sheet** will be created.

If the thin sheet is not visible in the current view, it is either too small to be seen, or it is outside the view. You can either select **Zoom Window** (if it's too small), **Zoom All** (if it's too large or outside the view) or **Zoom Selection** to make it visible.

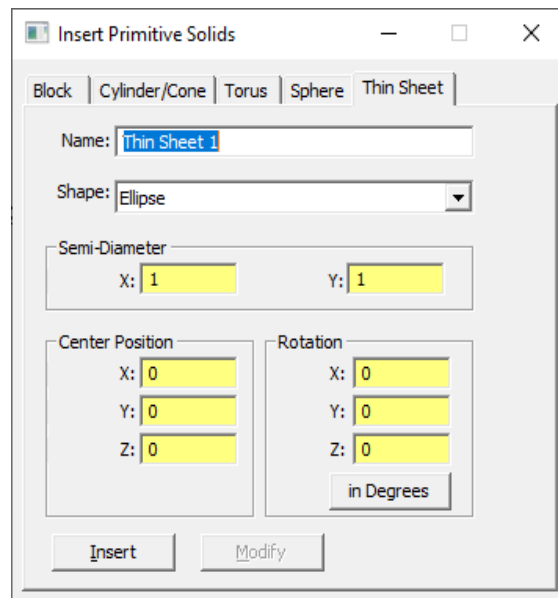

FIGURE 2.8 - Insert Primitive Solids dialog box: Thin Sheet tab

Name	Enter a name for the object
Shape	Choose the shape as either Circle, Ellipse, Rectangle, Regular Polygon, or Irregular Polygon
Dimension(s)	Enter radii or widths depending on the shape choice (except for Irregular Polygon)
Center Position	Enter the center position with X, Y and Z values (except for Irregular Polygon)
Rotation	Enter the rotation angles about the X, Y and Z axes (except for Irregular Polygon)
Points	Enter each vertex point with X, Y and Z values (Irregular Polygon only).
Insert	Create a new thin sheet object
Modify	Modify a previously created thin sheet object
Clear Grid	Erases all data from the cells

Limitations:

The thin sheet boundary must be closed. No part of the boundary is allowed to overlap another part of the boundary. TracePro closes the boundary by connecting the last point to the first point.

The thin sheet is ordinarily defined as a plane. If you define boundary points that do not lie in a plane, TracePro will create a spline surface to fill the polygon.

Since the thin sheet has no thickness or volume, applying material properties to the thin sheet can lead to misleading errors during a raytrace. For this reason application of the following property types to thin sheets is prevented: Material, Mueller Matrix, Gradient Index, Bulk Scatter, and RepTile.

Rubberband Primitives

In addition to the dialogs described above, some primitive solids may be defined interactively using rubberband tools. Spheres, Cylinders, Cones, and Blocks have rubberband tools.



To create a sphere:

1. Select the Sphere Tool.
2. Hold down the left mouse button and drag to define the radius of the sphere.
3. Release the mouse to display the object.



To define a Cylinder:

1. Select the Cylinder tool.
2. Hold down the left mouse button and drag up or down to define the base radius of the cylinder. The base radius is defined along the vertical axis of the screen.
3. Release the mouse button and drag left or right to define the length. The length is defined along the horizontal axis of the screen.
4. Click the left mouse button to complete the cylinder.



To define a Cone:

1. Select the Cone tool.
2. Hold down the left mouse button and drag up or down to define the base radius. The base radius is defined along the vertical axis of the screen.
3. Release the mouse button and drag left or right to define the apex of the cone. The length is defined along the horizontal axis of the screen.
4. Click the left mouse button to complete the cone.



To define a Block:

1. Select the Block tool.
2. Hold down the left mouse button and drag left or right to define the length of the block's square base. The length is defined along the horizontal axis of the screen.
3. Release the mouse button and drag up or down to define the height. The height is defined along the vertical axis of the screen.
4. Click the left mouse button to complete the block.

Defining TracePro Solids

TracePro allows you to define objects that are commonly used in optomechanical systems, namely a lens element, Fresnel lens, reflector, tube or baffle vane.

Lens Element



The **Geometry | Lens Element** menu or Insert Lens toolbar button opens a tabbed dialog box that allows you to specify completely a lens element including curvatures (or radii); thickness; material; aperture and obstruction shape and dimensions; and position and orientation of the element. You can make a mirror using **Geometry | Lens Element** by creating the mirror with the desired shape, then applying a reflective coating to it.

Note: An obstruction is a common term from lens design. An obstruction in TracePro creates a hole in the lens.

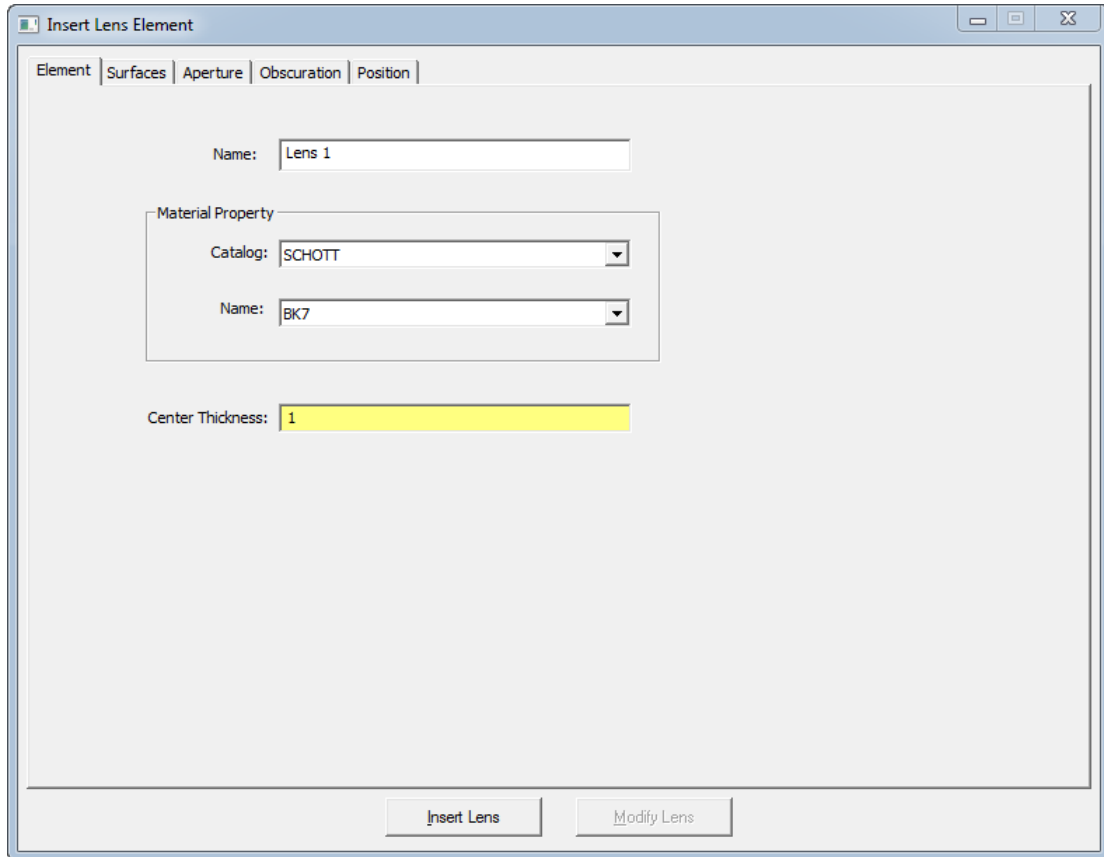

FIGURE 2.9 - Insert Lens Element dialog box: Element tab

After you have entered all the data to specify the element, click *Insert Lens* at the bottom of the dialog box to create the element. You can create as many elements as you wish. Simply edit the data for the new element and click *Insert Lens* again. To close the dialog box, click the close button on the top bar of the dialog box, or press the Esc Key on your keyboard.

The **Geometry|Lens Element** dialog box is a modeless dialog box, so you can leave it open while you do other things like inserting other solid objects, moving objects, changing the view, or applying properties.

Note the *Modify Lens* button in Figure 2.9. You can select an existing Lens object and then use the **Geometry|Lens Element** dialog box to access and change the data by clicking the *Modify Lens* button. Note that the Modify button will be disabled if you don't have an appropriate Lens selected in the model window.

An example of inserting a lens developed in the OSLO lens design software is shown in "Anisotropic Surface Property" on page 9.41

Element tab

Using the Element tab you can enter

1. Name of the element
2. Center thickness, the center-to-center distance between the two surfaces.

3. Material Catalog

4. Material Name

The default glass is SCHOTT BK7.

To edit a lens element: select the element, change entries, and click the Modify button in the **Geometry|Lens Element** dialog box. The Modify button lets you make a series of sequential edits.

Here are the steps to modify a lens element:

1. Select the lens object in the model window or on the system tree.
2. Select **Geometry|Lens Element**.
3. Edit the data and click *Modify Lens* in the dialog box.

TracePro applies your changes.

If you use another tool to edit a lens element—selecting one of the Boolean operations, for example—TracePro no longer recognizes that the lens element is still a “lens element.” For example, if you subtract a cylinder from a lens by the means of a Boolean operation, TracePro sees the result as a generic object rather than a lens object. You can use the “obstruction” tabbed dialog to accomplish the same step as long as the cylinder is aligned along the axis of the lens, and in this case the lens object status is retained.

Altering a lens element is best done by using *Modify Lens* from the **Geometry|Lens Element** dialog box. Editing the lens element in this way lets you go back as often as you want to make further changes.

Surfaces tab

The Surfaces tab defines the shape of each surface (for First Surface and Second Surface). Each surface has its own sag formula that is used to define the surface shape of the lens surface relative to the local surface center or vertex. The Base Sphere selection at the top of the dialog box determines whether you enter Radius or Curvature for surface types that require such an entry.

The following surface types are available for creating lens elements:

- Plane
- Sphere
- Conic
- Q-type asphere (Qcon)
- Q-type asphere (Qbfs)
- Rotationally symmetric asphere
- Asymmetric asphere
- Asymmetric general asphere
- Cylinder
- Torus
- Biconic
- ISO X-Toric
- ISO Y-Toric
- Symmetric cone

- Asymmetric cone
- Asymmetric Zernike
- Anamorphic
- Odd Cosine
- Superconic
- Radial Spline

The Plane surface type requires no data. The Sphere surface type requires only the radius (or curvature) of the spherical surface. The remaining surface types require more. Each surface type is described in the sections that follow.

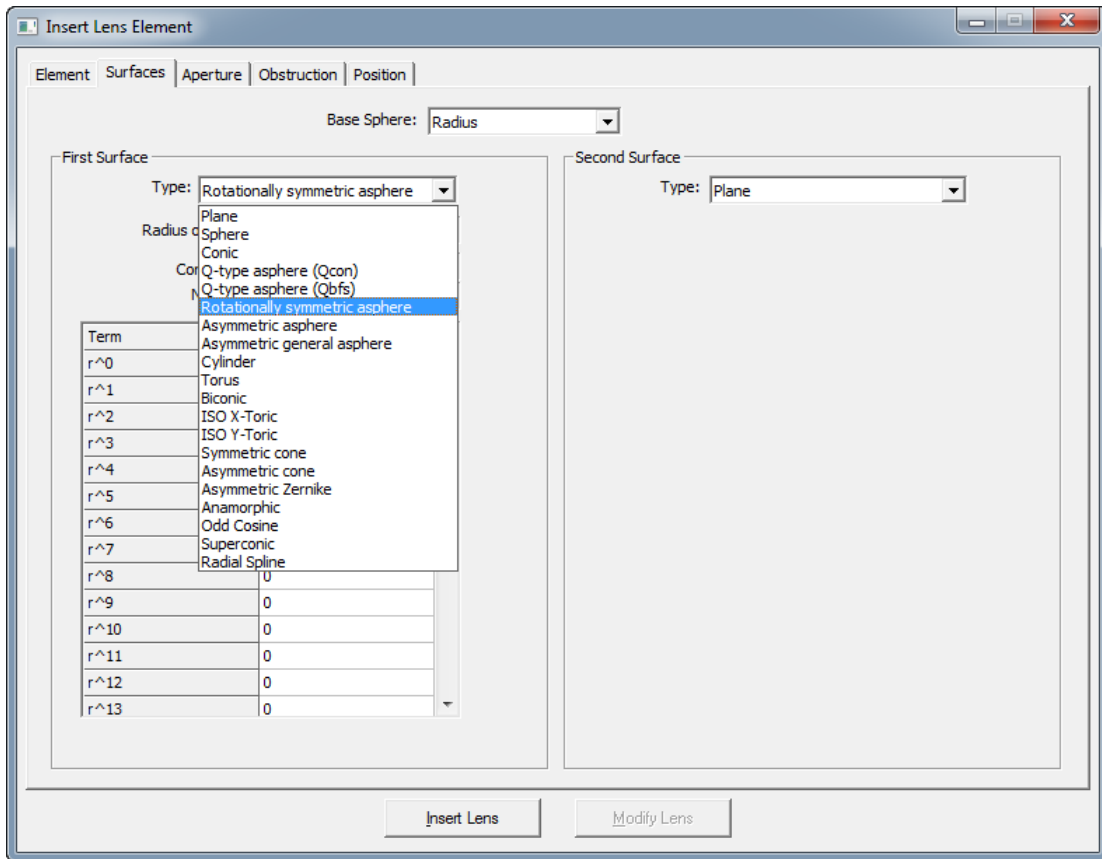

FIGURE 2.10 - Surfaces Tab in Insert Lens dialog

Conic

The conic surface is a conic section curve revolved to make a surface, and has the sag

$$z(x,y) = \frac{cr^2}{1 + \sqrt{1 - (1+k)c^2r^2}}$$

where c is the vertex curvature, k is the conic constant, and r is radial distance from the axis of symmetry. The meaning of different values of the conic constant is shown in Table 2.1.

TABLE 2.1. Conic Constant Values

K (Conic Constant)	Conic Type
$K < -1$	hyperboloid
$K = -1$	paraboloid
$-1 < K < 0$	ellipsoid (prolate spheroid)
$K = 0$	spheroid
$K > 0$	oblate spheroid

Q-type asphere (Qcon)

The Q-type asphere (Qcon), developed by Greg Forbes, consists of a base conic plus a series of radially symmetric orthogonal polynomials. The polynomials are a function of normalized radius u , where $u = r/r_0$, and r_0 is the normalization radius. The sag equation for a Qcon polynomial surface is

$$z(r) = \frac{cr^2}{1 + \sqrt{1 - (1+k)c^2r^2}} + u^4 \sum_{i=0}^N a_i Q_i^{con}(u^2)$$

where c is the vertex curvature, k is the conic constant, and r is radial distance from the axis of symmetry. The Qcon polynomials are best evaluated recursively. Nevertheless, here are the first few Qcon polynomials presented explicitly:

$$Q_0^{con}(x) = 1$$

$$Q_1^{con}(x) = -(5 - 6x)$$

$$Q_2^{con}(x) = 15 - 14x(3 - 2x)$$

$$Q_3^{con}(x) = -\{35 - 12x[14 - x(21 - 10x)]\}$$

$$Q_4^{con}(x) = 70 - 3x\{168 - 5x[84 - 11x(8 - 3x)]\}$$

Q-type asphere (Qbfs)

The Q-type asphere (Qbfs), developed by Greg Forbes, consists of a best-fit sphere plus a series of radially symmetric orthogonal polynomials. The polynomials are a function of normalized radius u , where $u = r/r_0$, and r_0 is the normalization radius. The sag equation for a Qbfs polynomial surface is

$$z(r) = \frac{cr^2}{1 + \sqrt{1 - c^2r^2}} + \frac{u^2(1 - u^2)}{1 + \sqrt{1 - c^2r_0^2u^2}} \sum_{i=0}^N a_i Q_i^{bfs}(u^2)$$

where c is the curvature of the best-fit sphere and r is radial distance from the axis of symmetry. The Qbfs polynomials are best evaluated recursively. Nevertheless, here are the first few Qbfs polynomials presented explicitly:

$$Q_0^{bfs}(x) = 1$$

$$Q_1^{bfs}(x) = \frac{1}{\sqrt{19}}(13 - 6x)$$

$$Q_2^{bfs}(x) = \sqrt{\frac{2}{95}}[29 - 4x(25 - 19x)]$$

$$Q_3^{bfs}(x) = \sqrt{\frac{2}{2545}}\{207 - 4x[315 - x(577 - 320x)]\}$$

$$Q_4^{bfs}(x) = \frac{1}{3\sqrt{131831}}(7737 - 16x\{4653 - 2x[7381 - 8x(1168 - 509x)]\})$$

Rotationally symmetric asphere

The Rotationally Symmetric Asphere surface consists of a conic plus a series of radial monomials. The sag equation is

$$z(x, y) = \frac{cr^2}{1 + \sqrt{1 - (1 + k)c^2r^2}} + \sum_{i=0}^N a_i r^i$$

To specify a rotationally symmetric asphere, enter the data for the base conic, the number of terms desired, and the coefficient of each term.

Asymmetric asphere

The Asymmetric Asphere surface consists of a conic plus a series of monomials of the form $|x|^j|y|^k$. The sag equation is

$$z(x, y) = \frac{cr^2}{1 + \sqrt{1 - (1 + k)c^2r^2}} + \sum_{i=0}^N a_i |x|^j |y|^k$$

where

$$i = \frac{1}{2}[(j + k)^2 + j + 3k]$$

The powers j and k can be determined from i using

$$o = \text{floor}\left(\frac{\sqrt{1+8i}-1}{2}\right)$$

$$k = i - o(o+1)/2$$

$$j = o - k$$

Asymmetric general asphere

The Asymmetric General Asphere surface consists of a conic plus a series of monomials of the form $x^j y^k$. The sag equation is

$$z(x, y) = \frac{cr^2}{1 + \sqrt{1 - (1+k)c^2r^2}} + \sum_{i=0}^N a_i x^j y^k$$

where

$$i = \frac{1}{2}[(j+k)^2 + j + 3k]$$

The powers j and k can be determined from i using

$$o = \text{floor}\left(\frac{\sqrt{1+8i}-1}{2}\right)$$

$$k = i - o(o+1)/2$$

$$j = o - k$$

Cylinder

The cylinder surface is a profile extruded nominally along the x axis, with profile equal to a conic section. The cylinder is specified by its radius (or curvature) and conic constant. The cylinder can be rotated away from the x axis using the Gamma rotation angle in degrees.

Torus

The torus surface is a profile swept along a circle nominally lying in the x-z plane, with profile equal to a conic section. The torus is specified by its radius (or curvature), conic constant, and sweep radius (or curvature). The sweep circle of the torus can be rotated away from the x-z plane using the Gamma rotation angle in degrees.

Biconic

The biconic surface has a conic section profile in both the x and y meridians, but generally with different radii and conic constants. In addition, series of monomials in $|x|$ and $|y|$ may be added to the base biconic. The general biconic surface has the sag equation

$$z(x,y) = \frac{c_x x^2 + c_y y^2}{1 + \sqrt{1 - (1 + k_x)c_x^2 x^2 - (1 + k_y)c_y^2 y^2}} + \sum_{i=3}^N a_i |x|^i + \sum_{j=3}^M b_j |y|^j$$

where c_x and c_y are x and y curvatures, and k_x and k_y are x and y conic constants. The biconic surface can be rotated about the z axis using the Gamma rotation angle in degrees.

ISO X-Toric

The ISO X-Toric surface is a profile in the x-z plane swept along a circle nominally lying in the y-z plane. The profile is a conic section plus monomial series in $|x|$. The torus is specified by its radius (or curvature), conic constant, sweep radius (or curvature), and monomial coefficients. The sweep circle of the torus can be rotated away from the y-z plane using the Gamma rotation angle in degrees. The sag equation of the ISO X-Toric surface is

$$z(x,y) = \frac{c_y(y^2 - g^2(x)) + 2g(x)}{1 + \sqrt{1 - c_y(c_y(y^2 - g^2(x)) + 2g(x))}}$$

where

$$g(x) = \frac{c_x x^2}{1 + \sqrt{1 - (1 + k_x)c_x^2 x^2}} + \sum_{i=0}^N a_i |x|^i$$

and c_x and c_y are x and y curvatures, and k_x is the x conic constant. The ISO X-Toric surface can be rotated about the z axis using the Gamma rotation angle in degrees.

ISO Y-Toric

The ISO Y-Toric surface is a profile in the y-z plane swept along a circle nominally lying in the x-z plane. The profile is a conic section plus monomial series in $|y|$. The torus is specified by its radius (or curvature), conic constant, sweep radius (or curvature), and monomial coefficients. The sweep circle of the torus can be rotated away from the x-z plane using the Gamma rotation angle in degrees. The sag equation of the ISO Y-Toric surface is

$$z(x,y) = \frac{c_x(x^2 - g^2(y)) + 2g(y)}{1 + \sqrt{1 - c_x(c_x(x^2 - g^2(y)) + 2g(y))}}$$

where

$$g(y) = \frac{c_y y^2}{1 + \sqrt{1 - (1 + k_y)c_y^2 y^2}} + \sum_{j=0}^M b_j |y|^j$$

and c_x and c_y are x and y curvatures, and k_y is the y conic constant. The ISO Y-Toric surface can be rotated about the z axis using the Gamma rotation angle in degrees.

Symmetric cone

The Symmetric Cone surface is comprised of a circular cone plus a series of radial monomials. The sag equation of the symmetric cone is

$$z(x, y) = c\sqrt{x^2 + y^2} + \sum_{i=3}^N a_i r^i$$

where the cone constant $c = 1/\tan(\theta)$, and θ is the half-angle of the cone.

Asymmetric cone

The Asymmetric Cone surface is comprised of an elliptical cone plus series of monomials in $|x|$ and $|y|$. The sag equation of the asymmetric cone is

$$z(x, y) = c_s \sqrt{\frac{x^2}{c_x^2} + \frac{y^2}{c_y^2}} + \sum_{i=3}^N a_i |x|^i + \sum_{j=3}^M b_j |y|^j$$

The asymmetric cone surface can be rotated about the z axis using the Gamma rotation angle in degrees.

Asymmetric Zernike

The Asymmetric Zernike surface consists of a base conic plus a series of Zernike polynomials. The sag equation of the asymmetric Zernike surface is

$$z(r, \theta) = \frac{cr^2}{1 + \sqrt{1 - (1+k)c^2r^2}} + \sum_{i=0}^N a_i Z_i(r, \theta)$$

where the Z_i are Zernike polynomials. The Zernike polynomials are separable in r and θ and are expressed in terms of orders n and m ,

$$Z_n^m(r, \theta) = R_n^m(r) \cos(m\theta)$$

$$Z_n^{-m}(r, \theta) = R_n^m(r) \sin(m\theta)$$

The Zernike Polynomials in TracePro are ordered by $n = 0, 1, 2, \dots$ and within each order n , by $m = -n, -n+2, \dots n$. The highest power of r in a given polynomial is equal to n . The number of Zernike polynomials used is controlled by setting the maximum value of n . The Zernike polynomials are evaluated recursively. Table 2.2 shows the numbering for the first few Zernike polynomials.

The Zernike polynomials are used with a normalized radius, $r' = r/r_0$. The asymmetric Zernike surface can be rotated about the z axis using the Gamma rotation angle in degrees.

TABLE 2.2. Zernike polynomial numbering

i	n	m	Zernike polynomial
0	0	0	1
1	1	-1	$r \sin \theta$
2	1	1	$r \cos \theta$
3	2	-2	$r^2 \sin 2\theta$

TABLE 2.2. Zernike polynomial numbering

i	n	m	Zernike polynomial
4	2	0	$2r^2-1$
5	2	2	$r^2\cos2\theta$

Anamorphic

The Anamorphic surface type is similar to the biconic surface type, but with a different series of extra terms. The sag of the anamorphic surface type is

$$z(x,y) = \frac{c_x x^2 + c_y y^2}{1 + \sqrt{1 - (1 + k_x)c_x^2 x^2 - (1 + k_y)c_y^2 y^2}}$$

$$+ a_0[(1 - a_1)x^2 + (1 + a_1)y^2]^2 + a_2[(1 - a_3)x^2 + (1 + a_3)y^2]^3 + a_4[(1 - a_5)x^2 + (1 + a_5)y^2]^4 + \dots$$

where c_x and c_y are x and y curvatures, and k_x and k_y are x and y conic constants. The anamorphic surface can be rotated about the z axis using the Gamma rotation angle in degrees.

Odd Cosine

The Odd Cosine surface type consists of a base conic plus a series of radial monomials, plus a series of radial-times-cosine terms with settable radial exponent, amplitude, frequency, and phase. The sag of the odd cosine surface is

$$z(x,y) = \frac{cr^2}{1 + \sqrt{1 - (1 + k)c^2 r^2}} + \sum_{i=1}^N a_i r^i + \sum_{i=1}^M A_i u^{P_i} \cos(B_i \theta + C_i)$$

where $u = r/r_0$ is normalized radius, r_0 is the normalization radius, c is the vertex curvature, k is the conic constant, and r is radial distance from the axis of symmetry. The odd cosine surface can be rotated about the z axis using the Gamma rotation angle in degrees.

Superconic

The superconic surface type is defined in terms of the radius from the vertex to a point on the surface rather than a cylindrical radius. The superconic is defined by the equation

$$Az^2 - 2Bz + C = 0$$

where

$$A = ck$$

$$B = 1 + \sum_{i=1}^N U_i r^{2i}$$

$$C = cr^2 + \sum_{i=1}^M V_i r^{2(i+1)}$$

$$r^2 = x^2 + y^2 + z^2$$

and c is the vertex curvature and k is the conic constant. These coefficients plus A , B , C , U_j and V_j are used to define a superconic surface.

Radial Spline

A Radial Spline surface is a cubic spline curve along a meridian that is revolved to create a surface. The curve is created by specifying slope values of the curve at different radii along the meridian. The sag of the surface between points $i-1$ and i is determined by

$$z = \frac{1}{6} c_{i-1} \frac{(h_i - r)^3}{h_i - h_{i-1}} + \frac{1}{6} c_{i-1} \frac{(r - h_{i-1})^3}{h_i - h_{i-1}} + \left[s_i - \frac{1}{2} c_i (h_i - h_{i-1}) \right] (r - h_i) + Z_{i-1} - \frac{1}{6} c_{i-1} (h_i - h_{i-1})$$

where h_i is the height along the meridian at point i , s_i is the slope, and c_i is the curvature. The curvature and sag values at each point are determined from the recursion relations

$$c_i = \frac{2(s_i - s_{i-1})}{h_i - h_{i-1}} - c_{i-1}$$

$$Z_i = \left[s_i - \frac{1}{6} (h_i - h_{i-1})(c_{i-1} + 2c_i) \right] (h_i - h_{i-1}) + Z_{i-1}$$

Aperture tab

Using the Aperture tab (see Figure 2.11) you set:

1. Aperture shape: defines the cross-sectional shape of the lens orthogonal to the axis. It can be Circle, Rectangle, Ellipse, Rounded Rectangle, or Polygon;
2. Aperture semi-diameters: the radii of the lens aperture in the X and Y directions in the model units. Note that the Y dimension is not allowed for a circle shape;
3. Aperture Decenters: the decenter of the lens in the X and Y directions in the model units;
4. Corner Radius: applies when a Rounded Rectangle aperture shape is selected;
5. Aperture gamma: the orientation of the lens aperture with respect to the optical axis, with X denoting the local horizontal axis and Y the local vertical axis. The value, either in Degrees or in Radians denotes the rotation of the lens aperture around the local Z (i.e., optical) axis; and

- Aperture second surface semi-diameter: allows for the second surface of a single lens to have a different semi-diameter than that of the first surface. Prescriptions from lens design codes (e.g., OSLO) often have this situation; therefore, the inclusion of this additional parameter ensures there is no loss of aperture data when clicking on the *Modify Lens* button;
- X Point and Y Point: allows entry of polygon vertices when Polygon aperture shape is chosen.

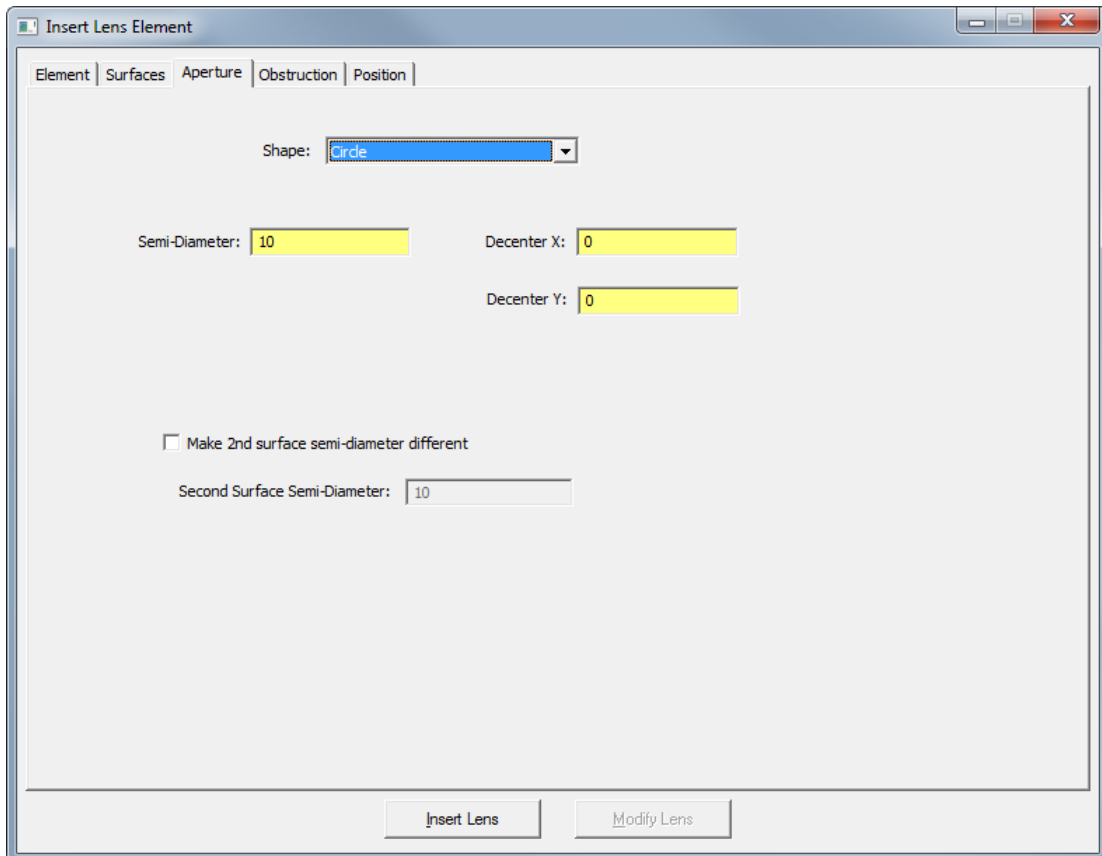

FIGURE 2.11 - Insert Lens Element dialog box: Aperture tab

Obstruction tab

The obstruction used by TracePro refers to an opening or hole in the lens. To truly obscure a portion of the lens, insert a thin block or cylinder with an opaque Surface Property. Using the Obstruction tab (see Figure 2.12) you set:

- Obstruction shape: options are None, Circle, Rectangle, Ellipse, Rounded Rectangle, and Polygon;
- Obstruction semi-diameters: the radii or half-widths of the obstruction in the local X and Y directions in the model units;
- Obstruction decenters: the decenters from the local optical axis of the obstruction in the local X and Y directions in the model units;
- Corner Radius: specifies the radius of corners for the Rounded rectangle shape;

5. Obstruction gamma: the orientation of the obstruction with respect to the optical axis, with X denoting the local horizontal axis and Y the local vertical axis. The value, either in Degrees or in Radians denotes the rotation of the obstruction around the local Z (i.e., optical) axis; and
6. X Point and Y Point pairs: allow entry of polygon vertices of the obstruction when Polygon shape is selected.

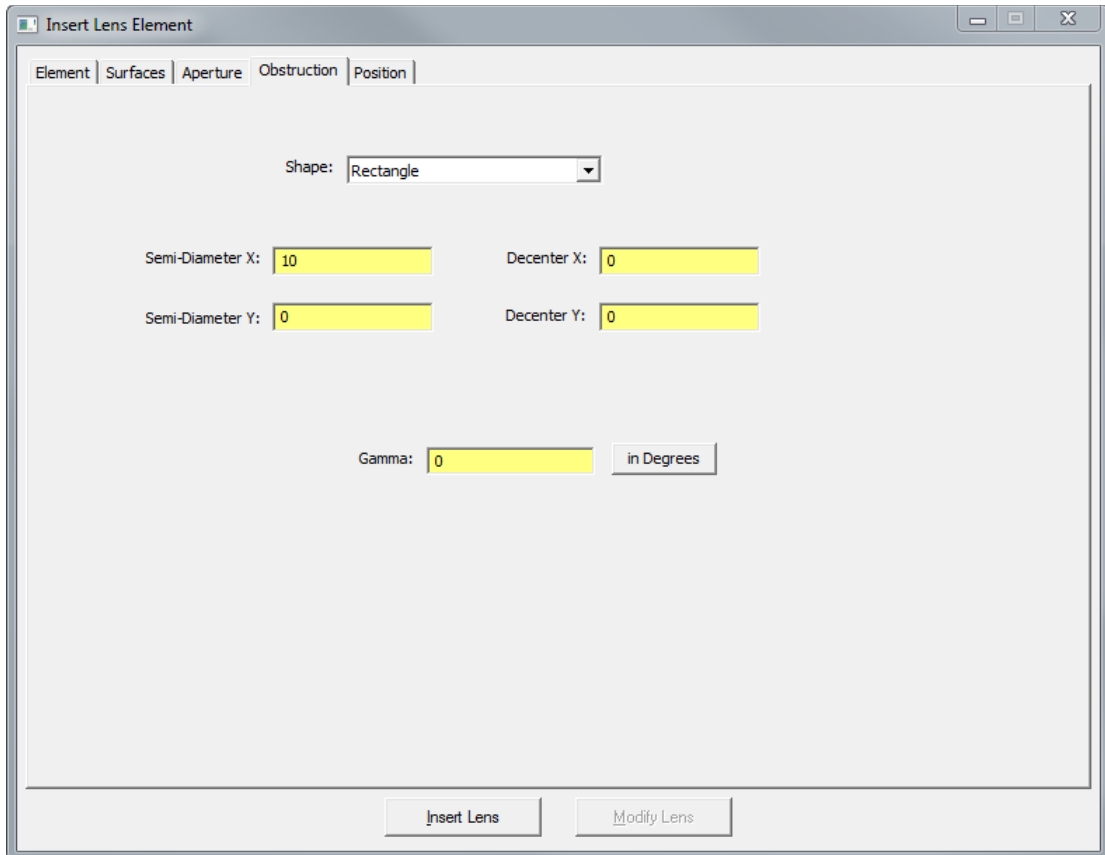

FIGURE 2.12 - Insert Lens Element dialog box: Obstruction tab with Rectangle obstruction selected.

Position tab

Using the Position tab (see Figure 2.13) you set:

1. The X, Y, Z coordinates of the vertex of the first surface of the element, in global coordinates;
2. The X, Y, Z rotation angles (tilt) of the first surface or entire element;
3. The X, Y, Z decenters of the second surface with respect to the first surface (i.e., these are local offsets with respect to item (1) above); and
4. The X, Y, A rotation angles (tilt) of the second surface of the element with respect to the first surface (i.e., these are local offsets with respect to item (2) above).

If you enter rotation angles, the surface/element is first rotated about the x-axis, then about the y-axis, and finally about the z-axis. Note that the first two rows in

this dialog box are in global coordinates, while the last two rows are in local coordinates with respect to the first two rows. If the latter two rows have no offsets, then the offsets are as globally indicated for the first surface Center and Tilt.

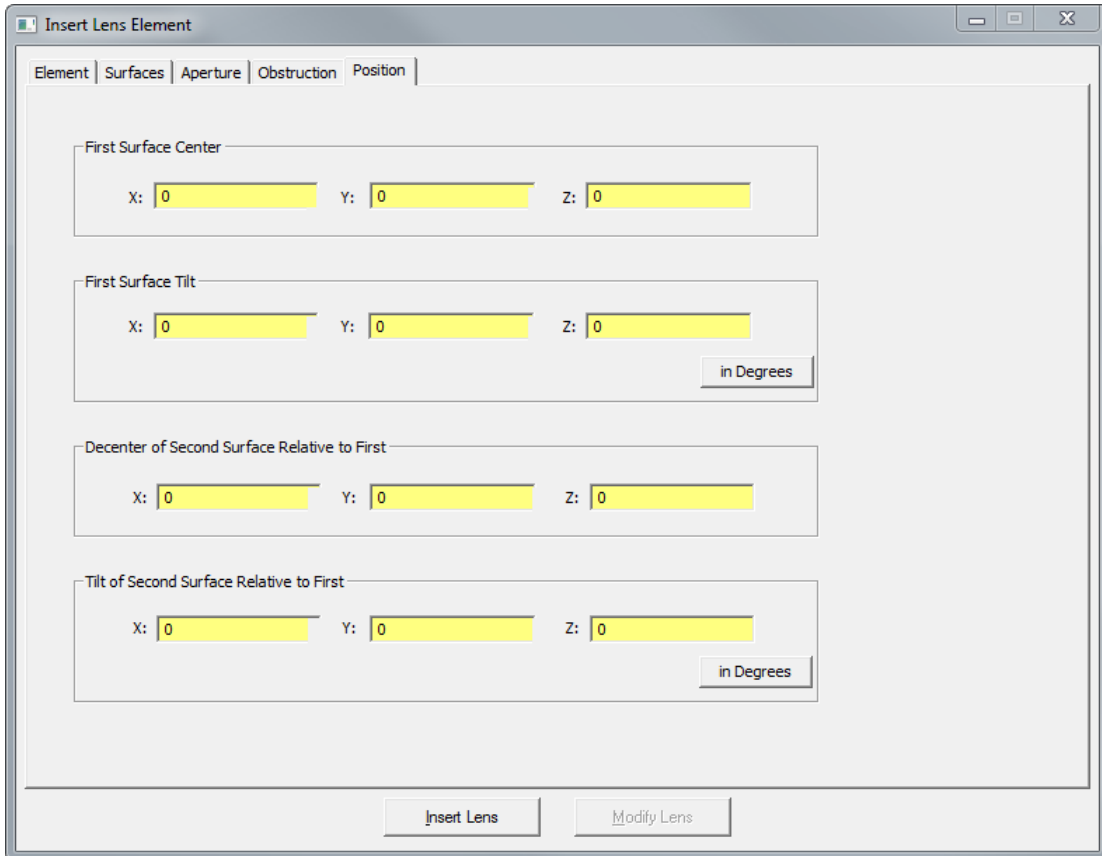

FIGURE 2.13 - Insert Lens Element dialog box: Position tab

Fresnel Lens

The **Geometry|Fresnel Lens** menu item opens a modeless dialog box that allows you to specify a Fresnel lens based on the material and the object and image distances. The dialog box allows you to enter:

1. Ring width or lines/unit length
2. Thickness of the substrate
3. Radius of the lens substrate
4. Material catalog, name, and design wavelength
5. Object distance
6. Image distance
7. Origin or location of the center of the part
8. Rotation angles specifying the orientation

TracePro interprets an object or image distance equal to zero as an infinite distance. Negative distances can also be entered for the case of a virtual object and/or image.

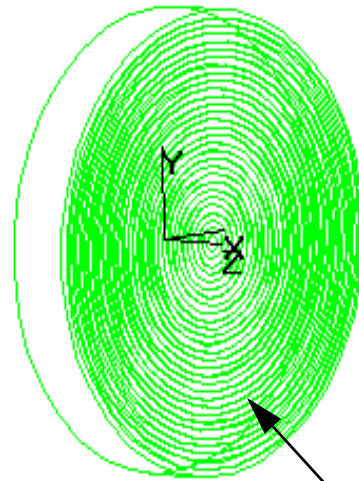
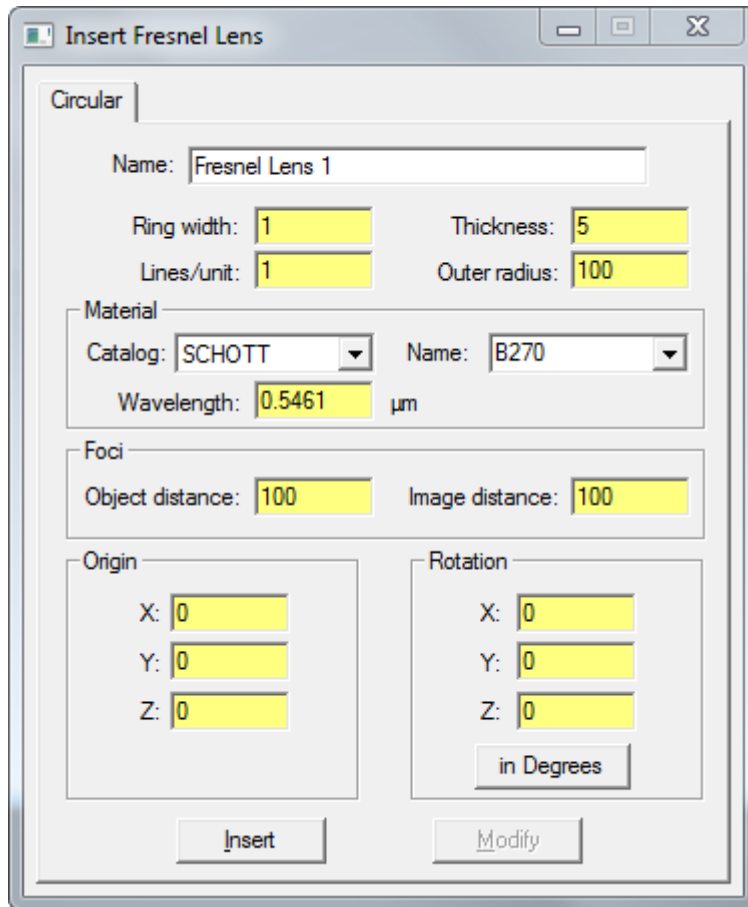

The Fresnel grooves are on the back surface of the element as drawn.

FIGURE 2.14 - Insert Fresnel Lens dialog box and resulting Fresnel Lens

The ring width specifies the width of the individual rings in the Fresnel lens, while the lines/unit length specifies the inverse of the ring width: the number of rings per unit length (e.g. 50 lines/inch). You can specify either one of these quantities, and the other will be updated.

The object and image distances specify point-to-point imaging. After entering all the data for the Fresnel lens, TracePro will build a Fresnel lens with conical facets that provide the requested imaging. The facet angles will be chosen so that light from a point on the left side of the lens at a distance equal to the object distance is imaged optimally into a point at a distance equal to the image distance on the right side of the lens, for the selected material and wavelength.

The formula for calculating the facet angles on the Fresnel lens is

$$\tan \beta = \frac{\sin \theta_1 + \sin \theta_2}{\sqrt{(n^2 - \sin^2 \theta_1) - \cos \theta_2}} \quad (2.1)$$

where θ_1 is the incident angle of light on the Fresnel lens, θ_2 is the angle of light leaving the Fresnel lens, n is the index of refraction of the material, and β is the facet angle. This formula produces an optimized or “aspheric” Fresnel lens, and is not equivalent to collapsing segments of a sphere onto a flat substrate.

Reflector



The **Geometry|Reflector** menu or Insert Reflector toolbar button opens a modeless dialog box that allows you to specify a reflector such as for a lamp or concentrator. The Insert Reflector dialog is a tabbed dialog box with six tabs for entering six different classes of reflectors and concentrators:

- Conic
- 3D Compound
- Trough (Cylinder)
- Compound Trough
- Rectangular Concentrator
- Facetted Rim Ray

A reflector consists of a curved piece of material with the thickness and shape specified in the dialog box. The sections below describe each class of reflector.

Conic

A conic reflector is a conic section of revolution, i.e., one of the following:

- Spherical
- Parabolic
- Elliptical
- Hyperbolic

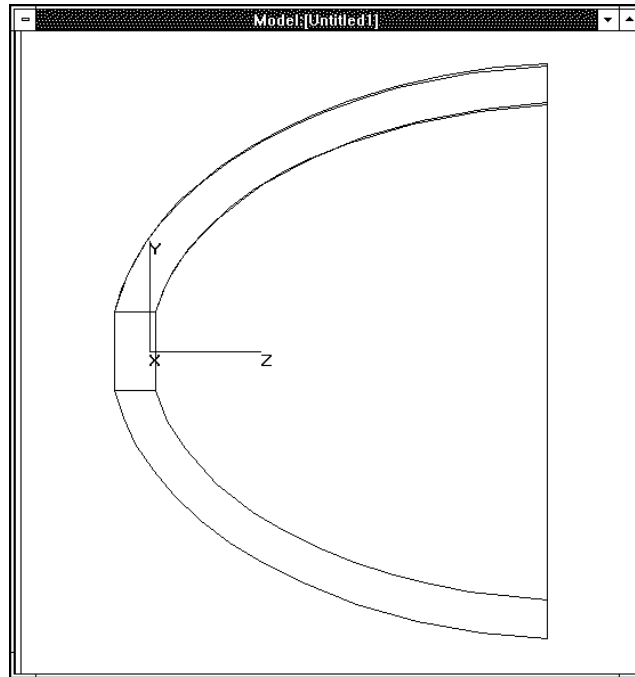

FIGURE 2.15 - Elliptical reflector with a hole at (0,0,0)

This dialog box allows you to specify the basic shape of the reflector (one of the above choices) as well as the focal length(s) or radius, as appropriate. You also specify the thickness, radius of a hole at the vertex, and the location and orientation of the reflector. A reflector specified with no rotation will be created in the orientation shown in Figure 2.15, with its axis of symmetry parallel to the z-axis, and the open end facing along the +z-axis.

Figure 2.15 shows an elliptical reflector with a hole at the vertex and located at the origin. The X, Y and Z coordinates of the origin serve to locate the vertex of the reflector. If you do not need a hole at the vertex, leave the hole radius set to zero.

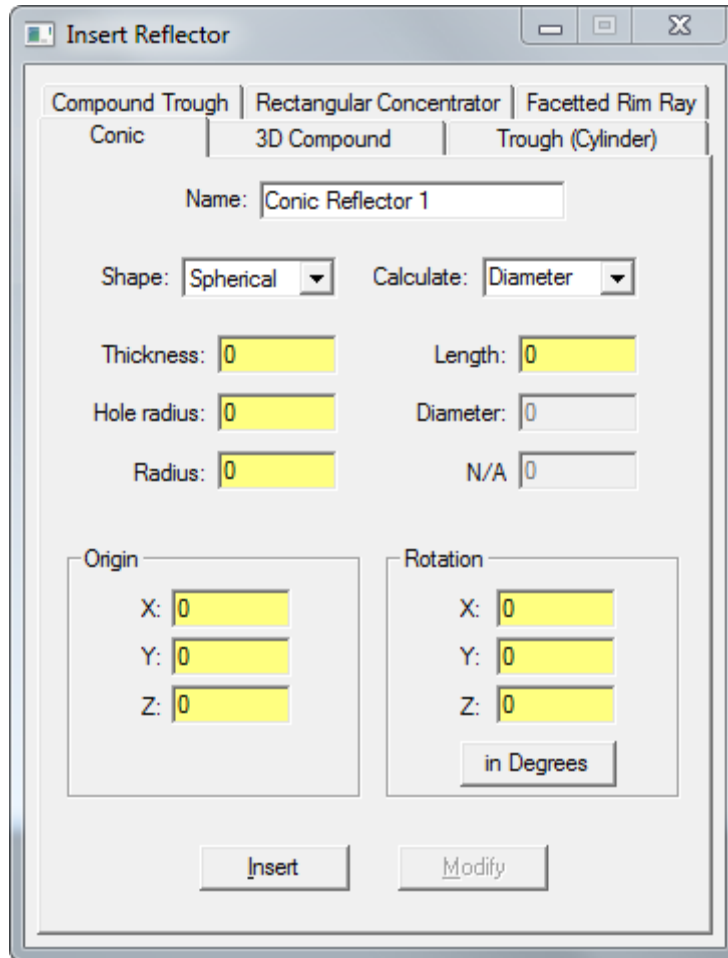

FIGURE 2.16 - Insert Conic Reflector Dialog

The parameters necessary to specify a conic reflector are:

- Shape (e.g. circular, elliptical, etc.)
- Length (the distance from the vertex to the end of the reflector)
- Diameter
- Radius of curvature (spherical)
- Focal length(s) (non spherical)
- Thickness
- Hole radius (radius of an optional hole at the vertex)
- Origin (X, Y, Z coordinates of the vertex)
- Rotation (X, Y, Z rotation angles about the vertex)

The length, diameter and radius/focal length(s) are related and you can select one value to be calculated using the Calculate drop down list and enter the others. For example, if you need a parabolic reflector to fit inside a known volume you can enter the length and diameter. Similarly, if you know the diameter and focal length you can calculate the length.

3D Compound

A 3D Compound reflector is a 3D compound concentrator. You can use this tab to make a:

- CPC (Compound Parabolic Concentrator),
- CEC (Compound Elliptical Concentrator)

This dialog tab actually allows you to make toroids formed by revolving parabolas and ellipses, special cases of which are CPCs and CECs. You enter the axis tilt, lateral shift, and length of the concentrator independently, so that you can create shapes other than ideal CPCs and CECs. To create ideal CPCs and CECs, you must solve for one of these parameters in terms of the others yourself, then enter the result in the dialog.

You can choose to make a solid or hollow concentrator by choosing the shape from the list in the dialog box.

The parameters necessary to specify a 3D Compound Reflector are:

- Shape (Hollow or Solid) and (Elliptical or Parabolic)
- Front length (the distance from the focal point to the entrance port end of the concentrator)
- Back length (the distance from the focal point to the exit port end of the concentrator)
- Lateral focal shift (equal to the exit port radius for a textbook concentrator)
- Thickness
- Axis tilt (equal to the acceptance angle for a textbook concentrator)
- Focal length(s)
- Origin (X, Y, Z coordinates of the center of the exit port)
- Rotation (X, Y, Z rotation angles about the center of the exit port)

Note: A Conic Reflector is a special case of a 3D Compound Reflector. You could make a Conic Reflector by setting the *Axis tilt* and the *Lateral focal shift* to zero in the 3D Compound Reflector dialog tab.

For more information on concentrators, see the textbook: [High Collection Nonimaging Optics](#), W.T. Welford and R. Winston, Academic Press, New York, 1989, ISBN 0-12-742885-2.

Parabolic Concentrators

A Compound Parabolic Concentrator (CPC) can be thought of as a parabolic toroid, i.e. a parabola revolved about an axis other than its axis of symmetry. A parabolic concentrator can be constructed by starting with a parabola, tilting it (about its focal point), displacing it laterally, then revolving it about its original axis of symmetry to form a surface.

A CPC is the best theoretical shape for concentration of light from a distant source when the parameters are chosen as described in Welford and Winston. TracePro also allows you to enter a CPC that is not an optimal concentrator surface.

In TracePro, the shape of a CPC is described by the Front length, the Back length, the Lateral focal shift, and the Axis tilt of the surface. The Origin and Rotation angles serve to locate and orient the CPC axis. The Back length allows you to

further depart from the textbook CPC. A textbook CPC has a Back length equal to zero. Increasing the Back Length grows the CPC lengthwise at the exit port end, while decreasing it makes the overall length shorter, this is called a truncated CPC. Both the Front length and the Back length are measured from the focal point of the parabola to either end of the CPC.

The parameters described are shown in Figure 2.17:

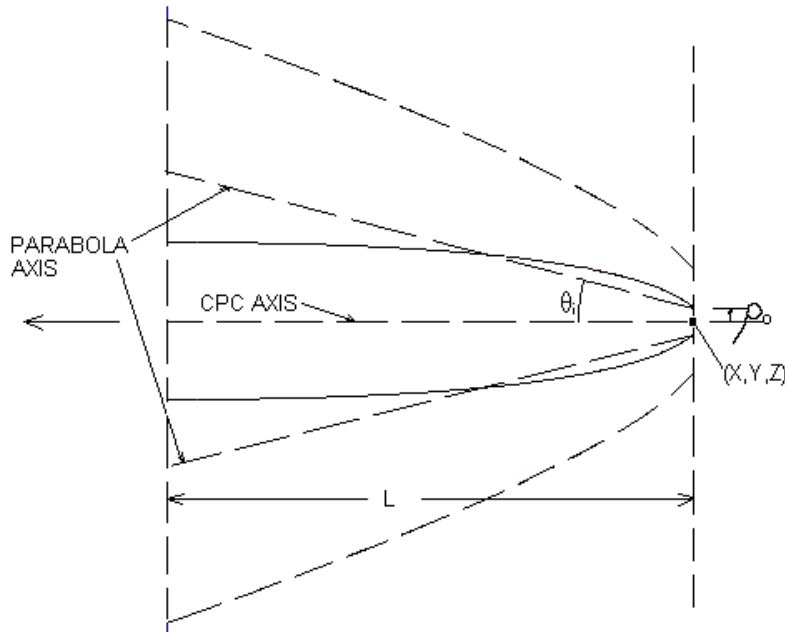

FIGURE 2.17 - Compound Parabolic Concentrator

The Origin is represented by the (X, Y, Z) coordinates, L is the Front length, θ_i is the angle Axis tilt, and ρ_0 is the Lateral focal shift.

To make a textbook, or optimal CPC, you can pick the acceptance angle (equal to the axis tilt angle) and the exit port radius, then solve for the focal length and the overall length of the concentrator. The focal length f is found from

$$f = a(1 + \sin\theta_i), \quad (2.2)$$

where a is the exit port radius and θ_i is the acceptance angle, and the overall length L is found from

$$L = \frac{a(1 + \sin\theta_i)\cos\theta_i}{\sin^2\theta_i} = \frac{f\cos\theta_i}{\sin^2\theta_i}, \quad (2.3)$$

You could also choose any two of these four parameters and solve for the other two using these two equations.

To enter this optimal CPC into TracePro, you would set the *Front length* equal to L, the *Back length* equal to zero, the *Axis tilt* equal to θ_i , and the *Lateral focal shift* equal to a. The lateral focal shift is equal to the radius of the exit aperture. For a solid CPC, the acceptance angle θ_i' is increased by the index of refraction n, i.e.

$\sin(\theta_i') = n \cdot \sin(\theta_i)$. See Welford and Winston for further discussion on 3D compound concentrators.

If you enter rotation angles, the concentrator is first rotated about the x-axis, then about the y-axis, and finally about the z-axis.

Trough (Cylinder)

A trough or cylinder reflector is a conic section that has been extruded to form a reflector that is uniform in cross-section and generally cylindrical in shape. Trough shapes that can be defined in TracePro are:

- Circular cylinder (an ordinary cylinder)
- Parabolic cylinder
- Elliptical cylinder
- Hyperbolic cylinder

A trough reflector can also have an optional slit along the length, at the vertex of the trough. To include more complex hole structure(s) in this and other reflector types, use the Boolean operations with bounding objects. Note that these Boolean operations will preclude the use of the Modify button on this menu because the object will no longer be seen a Reflector Object.

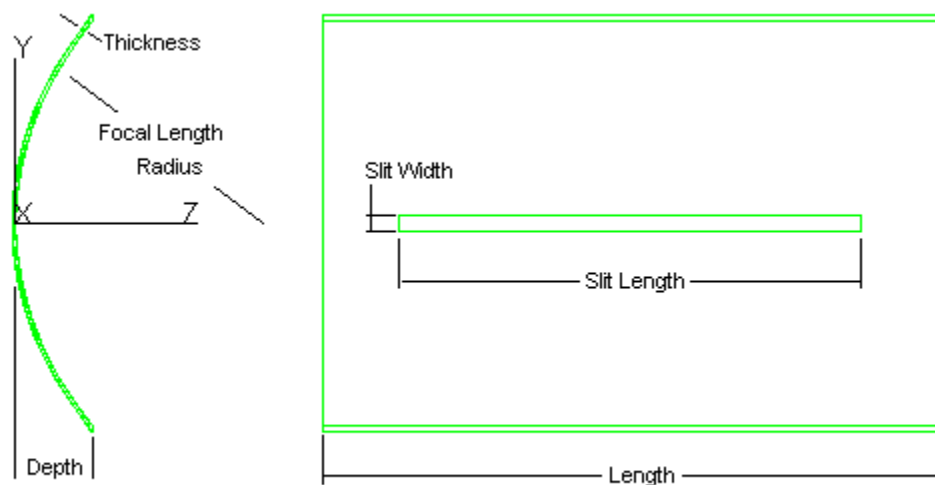

FIGURE 2.18 - Elliptical Trough with Slit

The parameters necessary to specify a trough reflector are:

- Shape (Circular, Elliptical, Parabolic, or Hyperbolic)
- Length (the length along the cylinder axis)
- Thickness
- Depth (distance from the vertex to the outer edge of the reflector)
- Slit width
- Slit length

- Focal length(s) (or radius for a circular reflector)
- Origin (X, Y, Z coordinates of the vertex)
- Rotation (X, Y, Z rotation angles about the vertex)

Compound Trough

A compound trough reflector is similar to a 3D compound reflector, except that the compound shape is extruded to form a trough instead of being revolved. The discussion for the 3D compound reflectors holds here, except that you must also specify the length of the trough (along the extrusion axis).

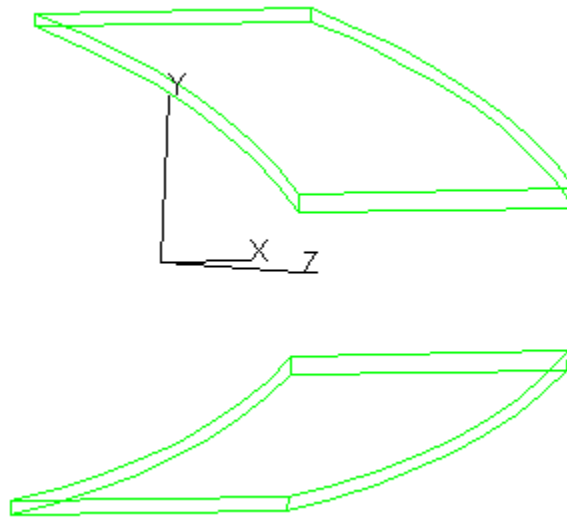

FIGURE 2.19 - Compound Trough Reflector

The parameters necessary to specify a Compound Trough Reflector are:

- Shape (Hollow or Solid) and (Elliptical or Parabolic)
- Front depth (the distance from the focal points to the entrance port end of the concentrator)
- Back depth (the distance from the focal points to the exit port end of the concentrator)
- Lateral focal shift (equal to the exit port radius for a textbook concentrator)
- Thickness
- Length (along the extrusion axis)
- Axis tilt (equal to the acceptance angle for a textbook concentrator)
- Focal length(s)
- Origin (X, Y, Z coordinates of the center of the exit port)
- Rotation (X, Y, Z rotation angles about the center of the exit port)

Rectangular Concentrator

A rectangular concentrator is comprised of two Compound Trough reflectors oriented at right angles to one another. This produces a concentrator that is a compound conic in either the x-z or y-z cross section, and is rectangular in any x-y cross section. In the Rectangular Concentrator dialog tab, there are inputs for two compound conics as well as the normal reflector parameters that are needed.

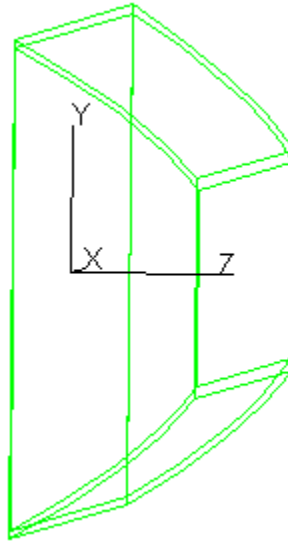

FIGURE 2.20 - Rectangular Concentrator Reflector

The parameters necessary to specify a Rectangular Concentrator Reflector are:

- Shape (Hollow or Solid) and (Elliptical or Parabolic)
- Front depth (the distance from the focal points to the entrance port end of the concentrator)
- Back depth (the distance from the focal points to the exit port end of the concentrator)
- Lateral focal shifts in X and Y (equal to the exit port radii for a textbook concentrator)
- Thickness
- Axis tilts in X and Y (equal to the acceptance angles for a textbook concentrator)
- Focal length(s) in X and Y
- Origin (X, Y, Z coordinates of the center of the exit port)
- Rotation (X, Y, Z rotation angles about the center of the exit port)

Facetted Rim Ray

Facetted reflectors are often used to produce a uniform irradiance distribution for an extended source. The facets provide smoothing of the reflector's output by perturbing the imaging qualities of the object. The Facetted Rim Ray in TracePro is an optimized reflector for a given source, package (or enclosure), and

irradiance plane. The package is defined by the dimension of the desired object enclosing the reflector.

To specify the reflector, start by locating the package Height, Y_p , and Depth Position (Location), Z_p , as shown in Figure 2.21. Enter the size of the source, Source Height, and distance from the vertex of the reflector, Source Location. TracePro will trace a ray from the top of the source to the package position (Y_p, Z_p), to the top of the target. The law of reflection will be used to determine the angle of the facet edge. TracePro will then extend the facet edge so a ray can be traced from the bottom of the source, to the bottom of the facet edge, to the bottom of the target. This defines the first facet edge. Additional facet edges will be defined until the reflector vertex is crossed. The profile will be revolved in steps based on the #Facets/Row to create the solid reflector.

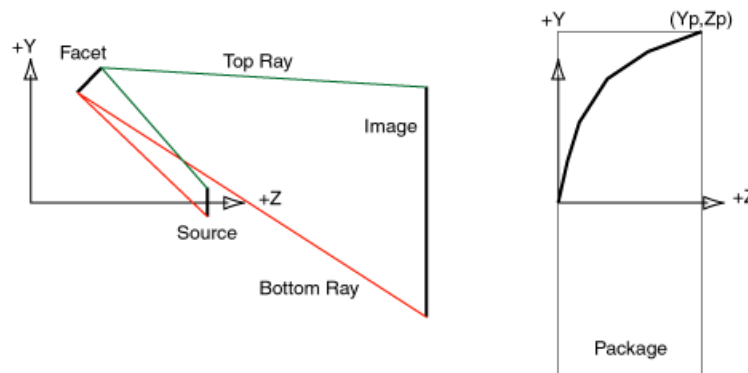

FIGURE 2.21 - Left: top and bottom rim rays traced for a single facet edge; Right: package and facet edges

Note: The rays shown in Figure 2.21 are used to define the edge of the first facet. The edge is then swept to create the first facet, and swept repeatedly to create all facets. Therefore, for a Circular Rim Ray Reflector, a ray traced to the final reflector will not produce the raytrace shown in Figure 2.21 as it is used for construction only.

The parameters necessary to specify a Facetted Rim Ray Reflector are:

- Thickness
- # Facets/Row (this is the number of facets created when the profile is sweep about the Z axis, for a circular reflector)
- Length (for a Trough reflector)
- Height (semi height of the package)
- Location (Z distance from the reflector vertex defining the depth of the package)
- Source Height (semi diameter of the source extent along the Y axis)
- Source Location (origin of the source as a Z distance from the reflector vertex)
- Target Height (semi diameter of the target extent along the Y axis)
- Target Location (origin of the target as a Z distance from the reflector vertex)
- Origin (X, Y, Z coordinates of the reflector's vertex)
- Rotation (X, Y, Z rotation angles about the reflector's vertex)

Tube



The **Geometry | Tube** menu or Insert Tube toolbar button opens a modeless dialog box that allows you to specify a tube such as might be used for a lens barrel or sunshade. You can create a tube with either an elliptical or rectangular cross-sectional shape. Cylindrical tubes have the same width or radius at each end of the tube, while conical tubes have different widths or radii at the two ends. Rectangular tubes can have different width and height dimensions at the two ends forming a Tapered Rectangular tube.

Using the Tube dialog you set:

- Wall thickness
- Length of the tube
- Cross-sectional shape, either elliptical or rectangular
- Inside radius of the base and top of an elliptical tube
- X half width and Y half width of a rectangular tube.
- Position of the base of the tube
- Rotation angles of the axis of the tube
- If the Base or Top is closed

If you enter rotation angles, the tube is first tilted about the x-axis, then about the y-axis, and finally about the z-axis. An unrotated tube has its axis along the z-axis.

The Tube dialog box is a modeless dialog box, so you can leave it open while you do other things like inserting other solid objects, moving objects, changing the view, or applying properties.

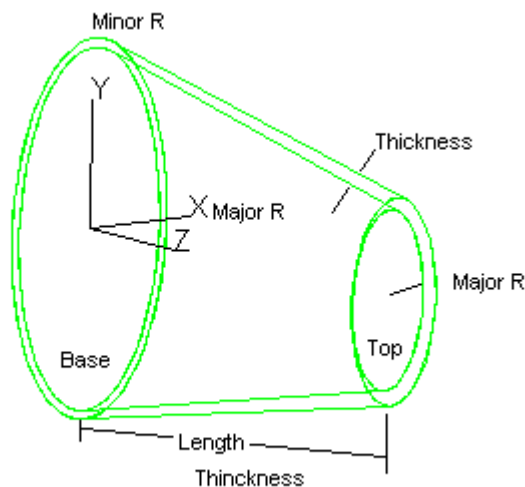

FIGURE 2.22 - Elliptical Tube

Baffle Vane

A baffle vane is usually made from a flat or conical sheet of metal in which a hole is cut, as shown in Figure 2.23. The edge of the hole normally comes to a point on

one side (i.e., like a chisel) to reduce scattering from the edge. However, the edge is never perfectly sharp due to manufacturing realities. The finite radius of the knife edge is modeled by a rounded cross-section or fillet, where this shape within TracePro is developed from a section of a torus. The outer edge of the baffle vane is cylindrical to be placed inside a cylindrical tube or lens barrel. Figure 2.23 shows a cross-sectional view of a baffle vane located with position (0,0,0) and rotation (0,0,0)

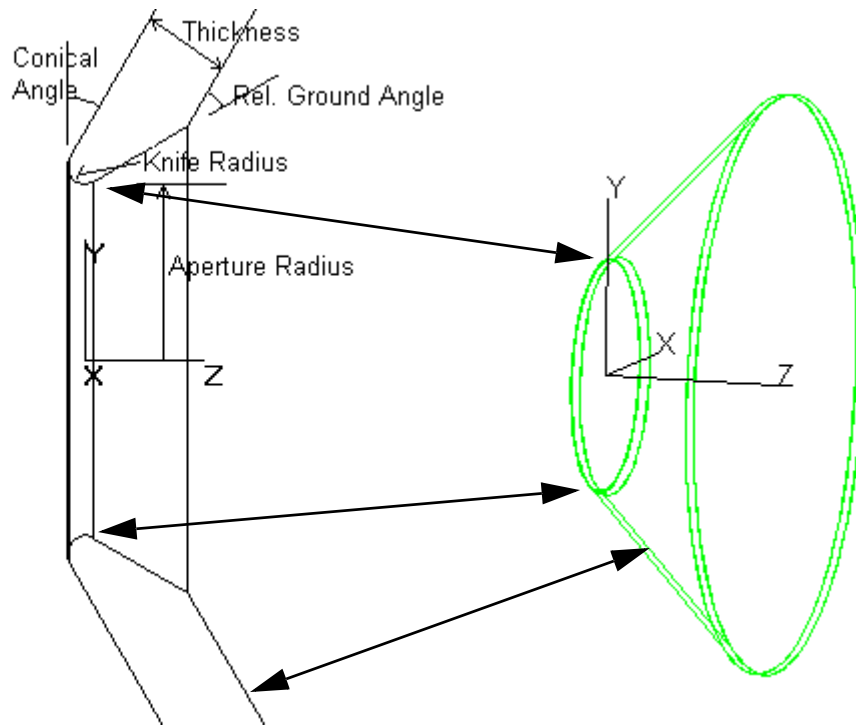

FIGURE 2.23 - Baffle Vane



Select **Geometry|Baffle Vane** or press the Baffle Vane toolbar button to open the Baffle Vane dialog. All of the dimensions necessary to specify a baffle vane are displayed:

- Aperture Radius - the radius of the hole in the baffle vane.
- Tube Radius - the outer radius of the vane. You should set this equal to the radius of the tube in which the vane fits.
- Thickness - the thickness of the sheet metal used to make the baffle vane.
- Knife Radius - the finite radius of the cross-section of the knife edge.
- Conical Angle - the half-angle of the cone from which the baffle vane is cut - equal to zero for a flat baffle vane.
- Relative Ground Angle - the angle at which the knife edge is sharpened relative to the surface of the sheet metal.
- Position - (X, Y, Z) coordinates of the center of the baffle vane aperture.
- Rotation - with no rotation, the axis of symmetry of the baffle vane is along the z-axis.

If you enter rotation angles, the baffle vane is first rotated about the x-axis, then about the y-axis, and finally about the z-axis.

The Baffle Vane dialog box is a modeless dialog box, so you can leave it open while you do other things like inserting other solid objects, moving objects, changing the view, or applying properties.

Boolean Operations

A common way to manipulate solid objects in a solid modeling program is to use Boolean operations. Boolean operations let you create complicated shapes from simple shapes. Boolean operations can also change the properties of an object. Therefore, they require care and planning in their use.

All three of the Boolean operators (Intersect, Subtract and Union) used in TracePro take two or more selections or operands, like arithmetic operators. The first selection represents the material and the second represents the tool. For example, to “drill” a hole in a block, you could position a cylinder inside a block, select the block and then the cylinder and then select **Edi t | Bool ean | Subtract**. The block would have a hole where the cylinder was subtracted from the block. In TracePro you can perform several operations on one object by selecting a first object for the material and several additional objects as tools, using a Shift (or Ctrl) Select selection. When selecting the tools, hold down the Shift (or Ctrl) key when pressing the left mouse button.

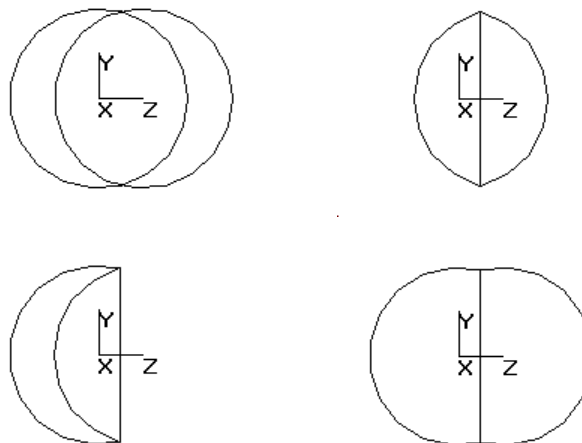

FIGURE 2.24 - Boolean Operations: Two Spheres, Intersection of Two Spheres, Subtraction of Two Spheres, and Union of Two Spheres

Perform Boolean operations before you assign property values (Material Properties, Surface Properties, and Source Properties).

Note: when you perform a Boolean operation, the choice of existing properties to apply to the resulting object is often ambiguous. TracePro may delete some properties during a Boolean operation.

Intersect

The Intersect operator takes two or more objects and produces the overlapping volume of the solid objects. If the objects do not overlap, the result of the intersection is to delete the objects.

For example, you can create a biconvex lens element by creating two spheres that overlap a small amount, then use the Intersect operator to create the intersection of the two spheres. Since the space that is inside both spheres is in the shape of a biconvex lens, the result of the Intersect operation is to produce a lens.

To use the Intersect operator select two or more objects, you must do a multiple selection in TracePro using the Shift or the Ctrl Key. For example, to intersect four objects:



1. Select **Edit | Select | Object** or click the Select Object toolbar button.
2. Select the first object. You may click on the object in the model window or use the system tree.
3. Press and hold the Shift (or Ctrl) key and select the second, third and fourth objects.



4. Press **Edit | Boolean | Intersect** or click on the Intersect toolbar button to complete the intersection operation.
5. The resulting object is the overlapping volume of all four objects.

Note: when you perform a Boolean operation, the choice of existing properties to apply to the resulting object is often ambiguous. TracePro may delete some properties during a Boolean operation.

Subtract

The Subtract operator takes two or more objects and subtracts the overlapping volume of each secondary object from the first object. If none of the secondary objects overlaps the first object, nothing happens. If any objects completely enclose the first object, the result of the subtraction is to delete all the objects.

Note: The result of Boolean Subtraction is highly dependant on the order in which the objects are selected.

For example, if you wish to subtract objects B, C, D, and E from object A, you can do this by first selecting objects A, B, C, D and E in a multiple selection, then select the Subtract operator to complete the operation. The result is

$$\text{result} = A - B - C - D - E$$

You can create a mirror with a hole in the center by first creating a mirror, then a cylinder that protrudes through the center of the mirror. Then use the subtract operator to subtract the cylinder from the mirror and thereby create the hole. An analogy with a machining operation helps: think of the first object as a part and the second object as a tool. The subtraction operation is like the tool cutting the part.

To use the Subtract operator select two or more objects, you must do a multiple selection in TracePro using the Shift or the Ctrl Key. For example, to subtract three subsequent objects from a “base” object:



1. Select **Edit | Select | Object** or click the Select Object toolbar button.
2. Select the first object. You may click on the object in the model window or use the system tree.

3. Press and hold the Shift (or Ctrl) key and select the second, third and fourth objects.



4. Press **Edi t | Bool ean | Subt ract** or click on the Subtract toolbar button to complete the intersection operation.
5. The resulting object will be the successive subtraction of each of the other three objects from the first object.

Note: when you perform a Boolean operation, the choice of existing properties to apply to the resulting object is often ambiguous. TracePro may delete some properties during a Boolean operation.

Unite

The Unite operator takes two or more objects and unites the total volume of the objects to form one single object. If the objects do not overlap, they are still united, in effect tied together. If one object completely encloses another, the result of the unite operation is to effectively delete the smaller object.

You can create a lollipop shape by creating a sphere and a narrow cylinder (a rod) that sticks into the sphere. Then use the unite operator to unite the sphere and the cylinder. After the operation, one object remains which is in the shape of a lollipop.

You can also use the unite operator to attach a baffle vane to a tube. Select **Edi t | Sel ect | Obj ect** or press the Select Object toolbar button, select the tube, shift+select the baffle vane, and then select **Edi t | Bool ean | Uni te** or press the Unite toolbar button. Remember that once the vane is united with the tube, there is no way to unattach it, unless you do it right away using **Edi t | Undo**.

To use the Unite operator select two or more objects, you must do a multiple selection in TracePro using the Shift or the Ctrl Key. For example, to unite four objects:



1. Select **Edi t | Sel ect | Obj ect** or click the Select Object toolbar button.
2. Select the first object. You may click on the object in the model window or use the system tree.
3. Press and hold the Shift (or Ctrl) key and select the second, third and fourth objects.



4. Press **Edi t | Bool ean | Uni te** or click on the Unite toolbar button to complete the intersection operation.
5. The resulting object is the total volume of all four objects.

Note: when you perform a Boolean operation, the choice of existing properties to apply to the resulting object is often ambiguous. TracePro may delete some properties during a Boolean operation.

Moving, Rotating, and Scaling Objects

You can move, rotate, and scale an object or group of objects using the **Edi t | Obj ect | Transl ate**, **Edi t | Obj ect | Move**, **Edi t | Obj ect | Rotate**, and **Edi t | Obj ect | Scal e** menu items, respectively. Any number of objects can be manipulated as a group. Simply select an object or objects with the mouse, then select the desired menu item. To select an object, click on it with the mouse. To select additional objects, hold down the Ctrl Key and click on them with the

mouse, or use the selection tool in rubberband mode to enclose a group of objects in the rubberband rectangle.

All of the dialog boxes are modeless, so you can leave them open to select new objects for moving, rotating, scaling, or to perform other operations. You can rotate, move, or scale object(s) in small increments by leaving the dialog box open, setting the parameters to small values, and repeatedly pressing *Apply*.

For an example using Move and Rotate to create arrays of objects see the example “Using Copy with Move/Rotate” on page 9.38.

Translate



To move a group of one or more objects interactively, select the objects with the mouse, then select **Edi t | Obj ect | Transl ate** or click on the Translate toolbar button. Using the mouse, press the left mouse button and drag the selection to a new location. Translate moves the object(s) along the plane of the screen, keeping the current depth coordinate - whatever it happens to be in 3D space. The Translate tool will be active until a new tool is selected.

Translate Copy

You can copy the selection by pressing the Ctrl key during the mouse dragging. When the left mouse button is released, new objects will be made from the selected objects and placed at the translated position.

Move

To move a group of one or more objects, select the objects with the mouse, then select **Edi t | Obj ect | Move** to open the Move Selection dialog box. The dialog box contains buttons to choose either Relative, Absolute or Distance along with X, Y, and Z values. You can use the Relative option to move the object relative to its own center, while the Absolute option places the object at the given global coordinates. For example, to move a selected object by 2 units along the z-axis, use Relative movement and set the values as follows:

X Center	0
Y Center	0
Z Center	2

Then press *Apply*, and the objects move by 2 along the z-axis.

When you select the Absolute option, the dialog will be updated to show the current location of the first object in the selection.

You can also move the selection a desired distance along a vector by selecting the Distance option, with a direction in (X,Y,Z) and distance entered in model units. This is similar to the relative move such that the distance is relative to the objects original position.

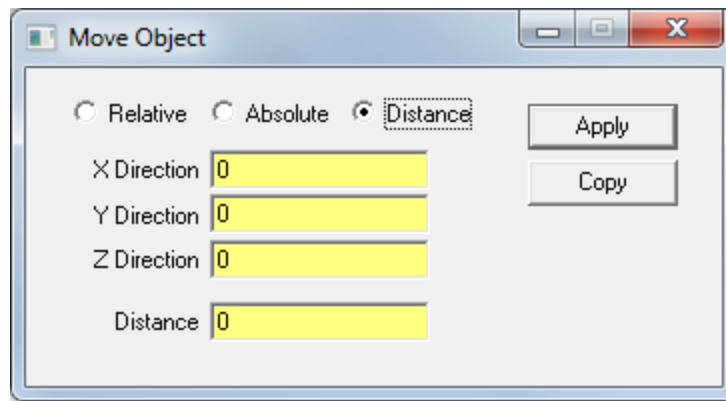

FIGURE 2.25 - Move dialog with the distance option selected

When more than one object is selected, the first object selected is moved to the location specified, while the other objects maintain their position relative to the first object.

Move Copy

Move Copy allows you to make a copy of an object and move it in one operation. This is much more convenient than manually copying the object, where the copied object is superimposed over the original. Move Copy is also a powerful tool for creating arrays of objects, using Move Copy Relative. This is because Move Copy makes a copy of the selected object(s), then moves the original to the coordinates specified. Once you have the X, Y, Z values defined and the object selected, you can repeatedly press the Copy button to make a row of objects, one for each button press. Once the row is completed, you can make an array by selecting the whole row of objects, then pressing Copy again, but with a different direction entered for the X, Y, Z values.

Note: If you apply surface and material properties **before** you do the Move Copy, the properties will be copied as well, saving you some effort later on.

Rotate

To rotate a group of one or more objects, select the objects with the mouse, then select **Edit | Object | Rotate** to open the Rotate Object dialog box. The dialog box contains a rotation angle, an axis about which to rotate and X, Y and Z values to specify a rotation point. A text box allows you to enter a number specifying the angle of rotation. Next to it is a button that enables you to specify whether the units for that angle are in degrees or radians. Rotations follow the right-hand rule.

The default units for rotations are degrees. If you prefer to use radians, press the button labeled *in Degrees* and it changes to *in Radians*. The rotation angle will be applied in radians.

Once you have entered the rotation angle, axis for rotation, and the rotation point, press Apply, and the selections are rotated.

Axis and Center of Rotation

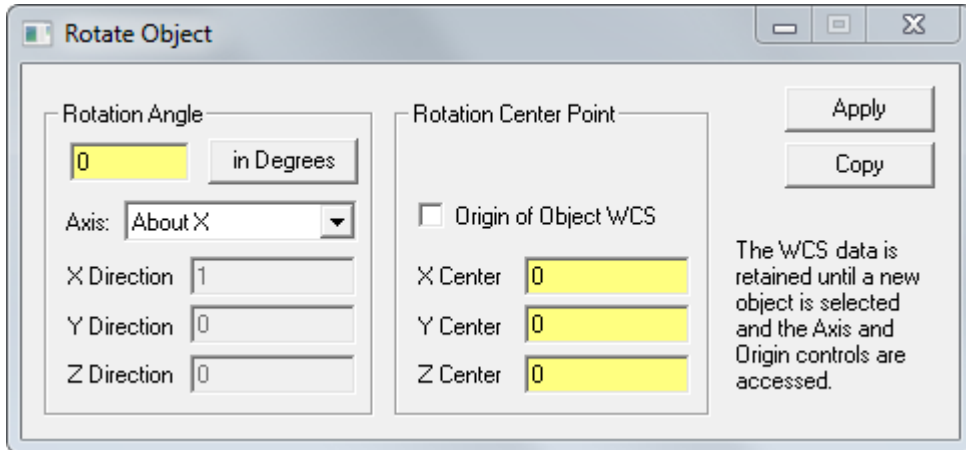

FIGURE 2.26 - Rotate Object Dialog Box

The *Axis* combo box has 7 choices to select the axis about which the rotation will take place:

- | | |
|----------------|---|
| About X | This is the global x-axis, the vector (1.0, 0.0, 0.0) |
| About Y | This is the global y-axis, the vector (0.0, 1.0, 0.0) |
| About Z | This is the global z-axis, the vector (0.0, 0.0, 1.0) |
| About Object X | This is the object's local x-axis, the vector (1.0, 0.0, 0.0)
Use View Display Object WCS |
| About Object Y | This is the object's local y-axis, the vector (0.0, 1.0, 0.0)
Use View Display Object WCS |
| About Object Z | This is the object's local z-axis, the vector (0.0, 0.0, 1.0)
Use View Display Object WCS |
| Customize | This allows any vector in global coordinates to be used for the axis of rotation |

The first 3 choices are rotations about the Global axis. The next 3 choices are rotations about the object's WCS axis. If more than one object is selected the first object in the selection is used. If *Customize* is selected, you can specify an arbitrary axis by input *X Direction*, *Y Direction*, and *Z Direction*. Every time you make a selection in the axis combo box the selected axis information is updated in *X Direction*, *Y Direction*, and *Z Direction* edit boxes.

You can either enter the center point or check *Origin of Object WCS* which means using the origin of the first selected object's WCS as the center point. At the time you check *Origin of Object WCS* the origin coordinates of the first selected object are displayed in *X Center*, *Y Center*, and *Z Center* edit boxes. If you wish to use global coordinates, enter numbers specifying the rotation center point. This will be the point around which the selected object will rotate after you click the *Apply* button in the dialog box.

Rotate Copy

Rotate Copy allows you to make a copy of an object and rotate it in one operation. This is much more convenient than manually copying the object, where the copied object gets superimposed on top of the original. Rotate Copy is also a powerful tool for creating arrays of objects. This is because Rotate Copy makes a copy of the selected object(s), then rotates the original by the values specified. Once you have the rotation values defined and the object(s) selected, you can repeatedly press the Copy button to make a curved row of objects, one object for each button press.

Note: If you apply surface and material properties **before** you do the Rotate Copy, the properties are copied, saving you some effort later on.

Scale

To scale a group of one or more objects, select the objects with the mouse, then select **Edit | Object | Scale** to open the Scale Selection dialog box. The dialog box contains a scale factor to specify the magnitude of the scaling. A scale factor greater than one enlarges the selection, while a scale factor less than one makes the object(s) smaller.

All scaling is done relative to the object's origin, so all points within an object (other than the origin) appear to shift when a scaling operation occurs. You can also scale the selection's position by checking the scale position box. This is useful for scaling groups of objects that must fit together.

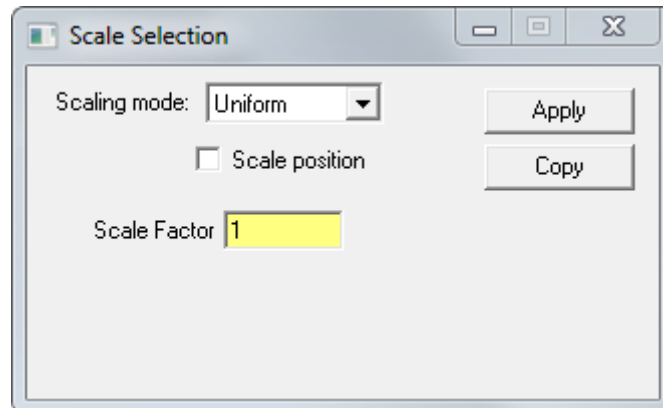

FIGURE 2.27 - Scale Selection Dialog Box

Scaling can be Uniform with X, Y, and Z directions having the same scaling factor, or Non-Uniform using different scaling factors. For example, you can scale a sphere into an ellipsoid by setting one scale factor to be different from the other two.

The non-uniform scaling option includes *Local WCS* and *Global WCS* selections. The scaling is performed in the three directions but can be made relative to the global coordinate system or to the object's coordinate system.

Once you have typed in the scale factor, press Apply, and the objects will be scaled.

Figure 2.28 shows the result of non-uniform scaling using Local and Global options. Two square blocks were created with a 45 degree rotation about the x-

axis and scaled with a *Y Scale Factor* of 2. The left block was scaled to the Global WCS and the Right was scaled to the block's Local WCS.

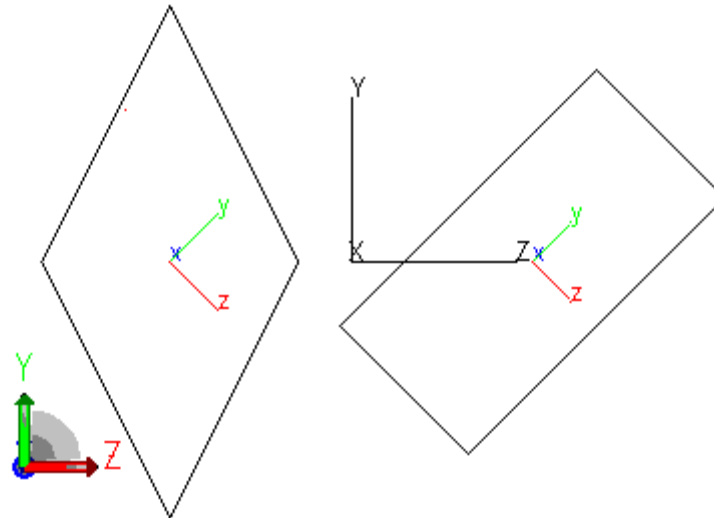

FIGURE 2.28 - Two blocks after non-uniform scaling

Scale Copy

Scale Copy allows you to make a copy of an object and scale it in one operation. This is much more convenient than manually copying the object, where the copied object will be superimposed on top of the original. Scale Copy is also a powerful tool for creating arrays of concentric or tapered objects. This is because Scale Copy makes a copy of the selected object(s), then scales the original relative to the origin by the specified scale factor. Once you have the scale factor defined and the object(s) selected, you can repeatedly press the Copy button to make a concentric set of objects (if the object is centered on the origin) or a tapered set of objects (if the original is not centered on the origin).

Note: If you apply surface and material properties **before** you do the Scale Copy, the properties will be copied as well, saving you some effort later on.

Orientation

Select **Edit | Object | Orientation** to display the position and Euler angle rotations of a selected object. The data is referenced from the object's Transformation Matrix. The Center Position column displays the center of the object in the current model units, while the Euler column displays the Euler rotations of the object. Rotations are performed in TracePro first about X, and then about Y and finally about Z. The Object's Orientation can be modified by entering a new position and/or Euler angles and pressing the *Apply* button.

Sweeping and Revolving Surfaces

Using the **Edit | Surface** menu selection, you can sweep and revolve surfaces in TracePro. Sweeping and revolving are ways of extending surfaces to create new shapes of objects. For example, if you create a solid cylinder, you can lengthen it by selecting one of the planar end surfaces, and using **Edit | Surface | Sweep** to

sweep it along the axis of the cylinder. You can make a corner on the end of the cylinder by sweeping the end face in a different direction. You can make a conical extension on the end of the cylinder by sweeping with a draft angle. Finally, you can make a bend on the end of the cylinder by revolving the end face.

Sweep

To sweep a surface:

1. Select the surface you wish to sweep by clicking on it with your mouse or selecting it in the system tree.
2. Select **Edit** | **Surface** | **Sweep** to open the Sweep Surface Selection dialog box.
3. Type in the Distance and Draft angle.
4. Now you must choose to sweep along the surface normal or manually enter a sweep direction using X, Y, and Z vectors.
5. Finally, press Apply to sweep the surface.

An example of the Sweep command is located in "Sweep Surface Example" on page 9.33.

Revolve

You can revolve a surface using the Revolve Surface Selection dialog box by selecting **Edit** | **Surface** | **Revolve**. Revolve is restricted to planar surfaces.

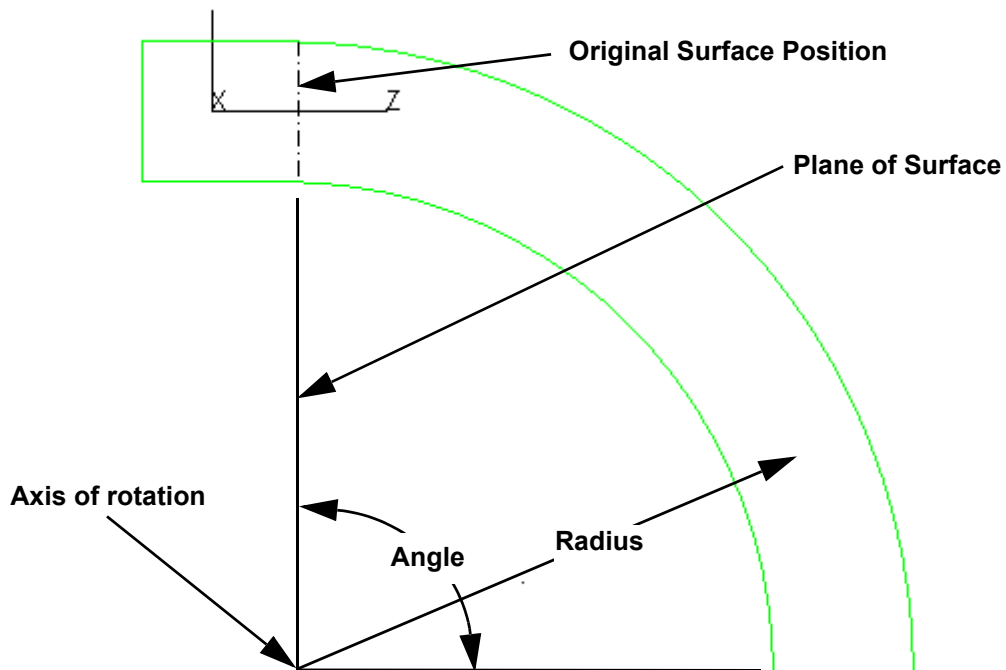

FIGURE 2.29 - Surface Revolve parameters.

To revolve a surface:

1. Select a planar surface

2. Select **Edit | Surface | Revolve** to open the Revolve Surface Selection dialog box.
3. Enter the Angle, Draft angle, Radius, and Steps.
4. Enter the axis direction data.
5. Choose a point about which to rotate. You can either: a) Type in the x,y,z values of the point directly, b) click a position in the Model Window and then click *Get Position from last mouse click*, or c) click *Calculate a Position using selected surface*. Option c will choose a point that is coplanar with the surface and one "radius" away from the center of the surface. The direction of the point is determined by the right-hand rule, i.e. it is along the direction of the cross product of the rotation axis with the surface normal.
6. Click Apply to revolve the surface. TracePro calculates the point about which the face will be revolved and displays it as the Position in a "grayed-out" display. The values in the dialog box have the following meanings.

Angle	Angle through which the surface will be revolved.
Draft Angle	Angle by which the revolved surface will be tapered.
Radius	Radius from the center of the surface to the axis of rotation.
Steps	=0: creates a continuous bend >0: creates a stepwise bend (a sequence of N+1 mitered sweeps)

An example of the Sweep command is located in "Revolve Surface Example" on page 9.36.

Notes Editor

The Notes Editor provides a text window to store information with a TracePro Model like a notebook where the comments are stored in the OML file. The editor includes common text formatting functions to highlight points, make lists and change text colors. All data is saved in Rich Text Format (RTF) to retain text formatting.

Open the Notes Editor with **Edit | Notes** or use the Notes Toolbar icon, .

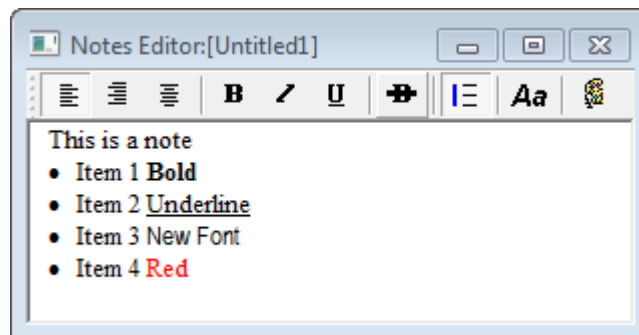











Figure 2 Notes Editor

The editor toolbar includes the following commands:

-  Left Align Text
-  Right Align Text
-  Center Align Text
-  Bold Text
-  Italicize Text
-  Underline Text
-  Strikeout Text
-  Bullet Text
-  Set Text Font
-  Set Text Color

Notes are saved with the TracePro Model by pressing the **File|Save** menu.

Importing and Exporting Files

TracePro can import files from many popular CAD formats.

To import a CAD file, open it in TracePro using **File|Open**, and select “Files of Type” to match the file type you wish to import. To export a CAD file, select **File|Save As**.

TracePro can import and export files via the IGES (*.igs, *.iges) and STEP (*.stp, *.step) interchange standards, and import files from popular lens design applications.

CAD Translators

The following CAD translators are accessible from the **File|Open** and **File|Save As** dialogs, by selecting the corresponding “Files of Type” or “Save As Type”: As of the date of this manual, the following are supported.

TABLE 2.3. Translators and file extensions

File Type	Read Versions	Write Versions
ACIS	*.sat	*.sat
AutoCAD	*.dwg, *.dxf	
Catia V4	*.exp, *.mod, *.model	
Catia V5	*.catpart, *.catproduct	
IGES	*.igs, *.iges	*.igs, *.iges
Inventor	*.ipt	
NX	*.prt	
Creo/ProE	*.prt, *.prt *, *.asm, *.asm.*	
SolidEdge	*.par, *.psm, *.asm	
SOLIDWORKS	*.sldprt, *.sldasm	
STEP	*.stp, *.step	*.stp, *.step

Plot formats for model files

A picture of the model window can be saved into bitmap (BMP) and Windows Enhanced Metafile (EMF) formats. Use the **File | Save As** dialog and the corresponding “Save As Type”.

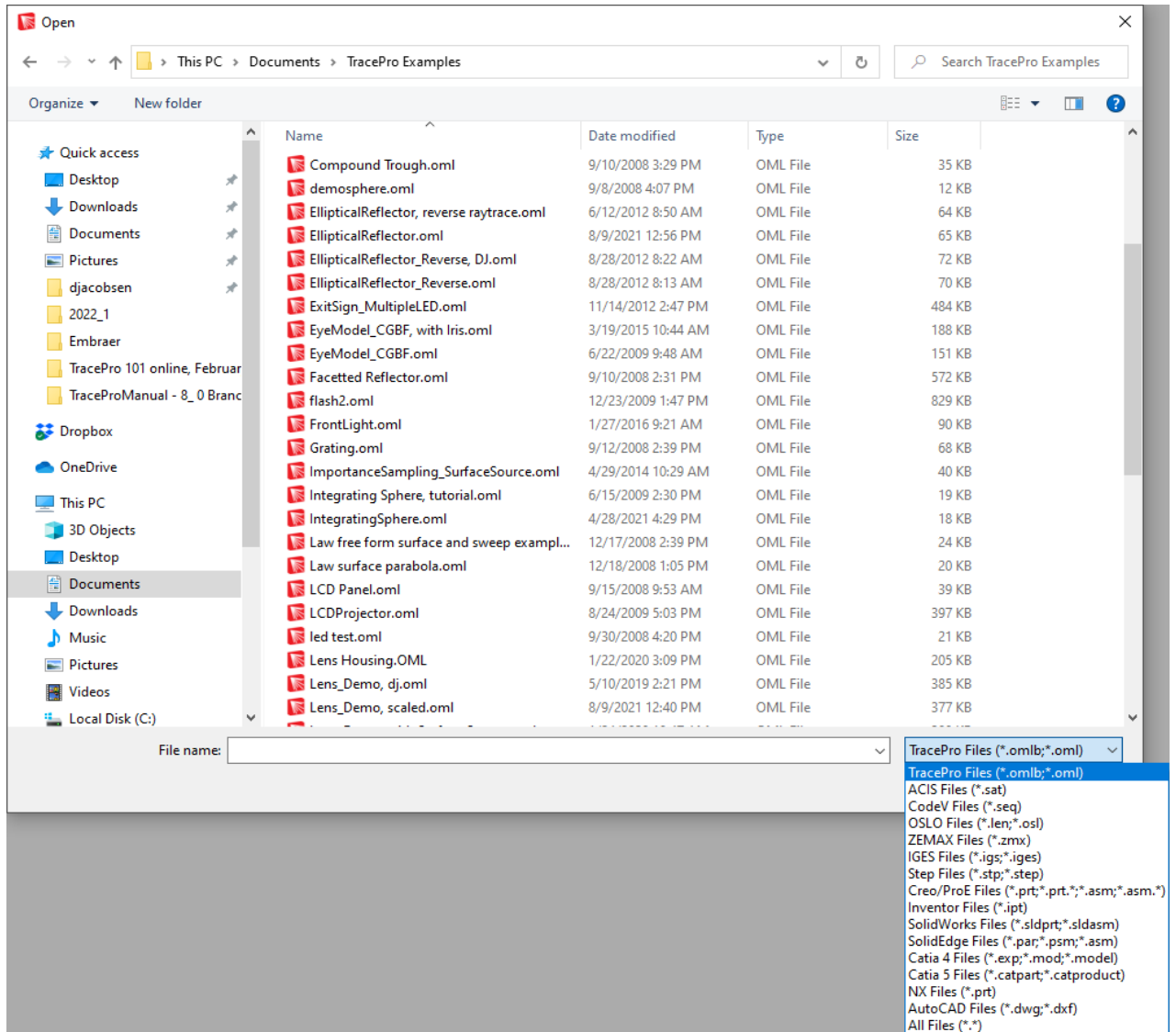

FIGURE 2.30 - File|Open dialog displaying selection of “Files of type”

Lens Design Files

You can import lens design data into TracePro from popular lens design programs, including Code V, OSLO, and Zemax. You can open the lens design data file as you would any other file, by selecting **File|Open**. TracePro automatically creates a solid model of the lens design using the curvature, thickness, material, and clear aperture data and saves it as an OML file. During the translation, TracePro converts the lens design materials to the equivalent TracePro materials. If clear aperture data are not present in the lens design file, TracePro may create grossly oversized clear apertures. You will probably find it easier to define the clear apertures in the lens design program before opening the file in TracePro.

Once the file is imported, you can apply Surface Properties in the usual way, just as if the model had been created in TracePro. TracePro reads and understands the material names in the lens design file and applies the appropriate Material Properties. If some material properties are not applied correctly, you can apply them manually in the usual way. You can check this quickly by using the System Tree and expanding the objects to see the material assigned to them. If an object has a material name but no catalog name, it will not be found when a raytrace is performed. You must look up the material using the drop-down lists in the Apply Properties dialog and apply the correct property.

A file is identified with a lens design program by the extension of the file as shown in Table 2.4. These are the only supported file types for the respective programs.

TABLE 2.4. File Extensions

Extension	Lens Design Program
SEQ	Code V Sequence file
LEN	OSLO file
OSL	OSLO file
ZMX	ZEMAX file

In the **File | Open** dialog box, there is a separate choice for each file format, in the *List Files of Type*: drop-down list at the bottom of the dialog box.

TracePro supports the following features in lens design files (please note that not all lens design programs offer all features):

- Radius or curvature input
- Conic constant (conic surfaces of revolution)
- Aspheric surfaces of revolution (up to r^{30})
- Global coordinate input
- Specification of material by glass name and manufacturer
- Surface tilts
- Decentered surfaces
- Decenter and return (Code V)
- Bend optical axis (Code V and OSLO)
- Reverse tilt/decenter (Code V)
- Circular, elliptical and rectangular clear apertures
- Decentered clear aperture
- Clear aperture rotations
- Circular, elliptical and rectangular obstructions
- Decentered obstruction
- Obstruction rotations
- Surface pickups (radius, thickness, material, aperture, obstruction, aspheric coefficients)
- Dummy surfaces as thin sheet with “No Trace” flag set
- Surface labels and notes

Note: Files containing prisms are difficult for TracePro to import. Most files are imported into TracePro correctly. Prisms are a notable exception. Simple wedges may import correctly, but complex prisms will often appear as overlapping objects. It is necessary to manually construct the prisms within TracePro.

Merging Files

Often when merging lens design data with data from a CAD program, the coordinate systems do not coincide. The **File|Merge** dialog box gives you a way to resolve the differences in the coordinate systems by converting one of the files to the coordinate system of the other.

In mechanical CAD programs, it is customary to build models with the x-axis pointing to the right and the y-axis or z-axis pointing up. In most optics programs, including TracePro, the z-axis points to the right and the y-axis points up, leaving the x-axis pointing into the screen.

To use Merge, you must have one of the two models open in a TracePro window. Then you can merge the second file with the open one using Merge.

With one of the models open, select **File|Merge** to open the Merge dialog. You can manually enter the rotation angles and translation of the second model relative to the first, or you can use default rotation angles. When you press one of the Default Model Rotations buttons, TracePro fills in the *Rotation Angles for New Model* entries according to the conventions outlined above. Use the *To CAD* button if the open model is in a CAD coordinate system and you are merging an optical design. Use the *To Optics* button if you have a lens design open and you are merging a CAD solid model. Optionally enter any coordinate shift between the two in the Translation for New Model fields. Finally, press *Merge* and the *File Open* dialog appears. Select the file you wish to merge and press OK.

Rotations are Euler rotations according to the right-hand rule. You can remember this using the mnemonic y-z-x. All rotations can be remembered using this rule, where the axes are always in the order x-y-z-x-y-z. Then an x rotation is y into z, and a z rotation is x into y.

Inserting Files

You can insert one model into another by using the **Geometry|Insert Part** menu item. You can keep files of standard parts on disk and insert them into existing models. Choosing the **Geometry|Insert Part** menu item opens the *Open File* dialog, but the model in the file is inserted into the currently open model instead of going into a new window.

Update from RayViz

The menu selection **Geometry|Update from RayViz** allows you to update your TracePro model from SOLIDWORKS via RayViz. If you are using SOLIDWORKS with the RayViz add-in, simply export the updated model from SOLIDWORKS using RayViz. Then, in TracePro, select **Geometry|Update from RayViz** to insert the model into your current TracePro model. TracePro remembers which objects came from SOLIDWORKS, and will replace them with the new objects in the RayViz exported model. Any objects that were changed in TracePro will not be affected.

Geometry Toolbar button available for Update from RayViz

Changing the Model View

TracePro allows you complete flexibility in changing the view of the model. You can have as many windows on each model open at one time as you wish. The view in each window is changed by using menu items on the **View** menu. Many of these are available on the *View* toolbar as well.

There are four types of views available in TracePro: Silhouette, Wireframe, and Render. Silhouette is the default view, the one that is active when you open TracePro or a new model. Wireframe view puts a wire grid on top of the surfaces to give a 3D impression of their shape. Render view makes the objects appear solid with shading based on the angle of incidence of an external, fictitious light source. The Render view assumes that the light source is located at the eye position of the viewer. *All of the functions of TracePro can be carried out in any type of view.* For example, you can select objects or Boolean operations in Silhouette, Render, or Wireframe.

Figure 2.31 shows an example of a model viewed in Render mode.

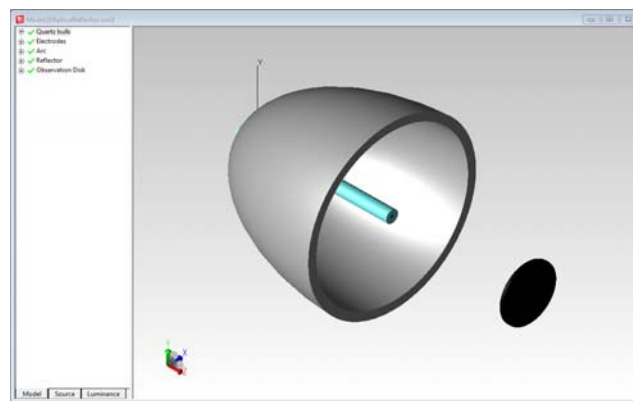

FIGURE 2.31 - Render view of the Elliptical Reflector

The **View | Set View** dialog box shows the underlying philosophy behind setting the view in TracePro. This dialog box lets you set:

- Eye position
- Target Position
- Up Vector
- Perspective View On/Off

The eye position, target position and up vector can be set by entering numbers in this dialog box, or by manipulating the view interactively as described in the following sections.

The eye position is a point in 3D space from which the geometry is viewed. The target position is a point in 3D space that the eye is looking toward. When you set the target position, TracePro sets the current model window so that the target position is at the center of the window.

Sometimes the view may become clipped in TracePro, causing parts of the model to disappear or be cut off. This happens when the eye point is inside the model – parts of the model that are behind the eye point are not displayed. You can ameliorate this problem by changing the coordinates of the eye point so that they are outside the model using **View|Set View**, or by selecting **View|Zoom All**.

The Up vector is a vector in 3D space that determines the orientation of the view. When you set the up vector, TracePro rotates the view until the up vector lies in the plane of the screen pointing in the up direction.

The perspective check-box allows you to turn perspective viewing on or off to aid in visualizing the model.

Once you have entered the numbers you desire for controlling the view, click *Apply* to see the resulting view. However, you will probably find it more convenient to use the interactive viewing controls.

Zooming

TracePro provides many different ways of zooming the window view in and out:



- Zoom In — Zooms in by a preset factor, the zoom factor is set in **View|Options|View**



- Zoom Out — Zooms out by a preset factor, the zoom factor is set in **View|Options|View**



- Zoom Ratio (no icon) — Opens a dialog box to type in a zoom factor



- Zoom Cursor — Zooms in as you hold down the left mouse button and move the mouse up in the TracePro model window, OR —Zooms out as you hold down the left mouse button and move the mouse down in the TracePro model window, OR if you have a wheel mouse, you can use the wheel to zoom in or zoom out, OR with a Shift-middle mouse button click.



- Zoom Window — Zooms to fit the rectangle formed by dragging a rubberband rectangle with the cursor. This can also be activated with a Ctrl-middle mouse button click.



- Zoom All — Zooms in or out until all the objects in the model are visible in the window, with a margin of 10% around the edge.



- Zoom Selection — Zooms in or out until all the objects in current selection are visible in the window.

The preset factors for Zoom In and Zoom Out can be changed using the Zoom tab of the **View|Options|View** dialog box. The factory preset values are 2.0 and 0.5, respectively. A separate value, which is 1.1 by default, is used for the wheel mouse zooming.

Choosing *Single-use zoom window* means that after you complete a Zoom Window command, the Zoom Window mode is exited, and the toolbar button becomes unpressed. The default mode, in which the *Single-use zoom window* box is unchecked, means that Zoom Window remains in effect until you disable it by either clicking the Zoom Window toolbar button to toggle it, or by choosing another zoom or selection tool.

The Zoom In, Zoom Out, Zoom Window, Zoom Cursor, Zoom Selection, and Zoom All commands are available on the View toolbar.

Panning

The **View|Pan** menu item, also available on the View toolbar, allows you to move the view side to side and up and down. First choose the **View|Pan** menu item or press the Pan toolbar button to enter panning mode. Then, while holding down the mouse button, drag the mouse cursor around in the view. It is as though you are dragging the objects in the window, but you are really dragging the view. The Pan tool can be activated by pressing Ctrl-right mouse button.

Panning is equivalent to moving the eye position and the target position in unison, keeping the target position in a plane perpendicular to the line between the two points.

Rotating the View

There are many different ways to rotate the view. Two of them are accessed from menu items:

- **View|Profile**
- **View|Rotate**

View|Profile lets you choose from five preset viewing angles: three orthogonal views and two oblique views. They can be chosen from the toolbar as well as the **View|Profile** menu. On the menu, the orthogonal views are listed as XY, XZ, and YZ, according to the axes that are visible in each view. The oblique or isometric views are illustrated by their buttons on the toolbar. The first, Iso 1, has the y-axis pointing up, the z-axis pointing to the right and toward you, and the x-axis to the right and away from you. The second, Iso 2, has the y-axis pointing up, the z-axis pointing to the right and away from you, and the x-axis to the left and away from you. The Rotate tool can be activated by pressing SHIFT-right mouse button.

You can also use the arrow keys on your keyboard to rotate the view.

Named Views



Named Views are accessed by selecting **View|Named Views**. The Named Views dialog is displayed, as shown below. The five default view orientations are listed and can be activated from the View menu, View Toolbar or Named Views dialog. These views will not change the Zoom factor of the Model Window. A new default view, Normal To, will change the view orientation to the surface normal of a selected planar surface. If the selection is invalid a message will be displayed. Any view can be saved by entering a View Name in the dialog box and pressing **Save View**. The Zoom and View data including rotation and pan will be stored and

available for future recall. The new views are added to the listing in the dialog and are saved in the model's OML file.

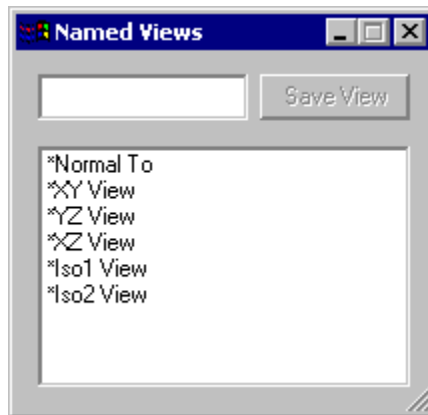

FIGURE 2.32 - Named Views dialog

Previous View



The View History will store the previous 10 views. Selecting **View | Previous View** or the Previous View tool will change to the view.

All-mouse Mode

This command allows you to move the view of the model in the model window using your mouse. When All-mouse mode is active, use the left mouse button to orbit the view, the right mouse button to zoom the view (like Zoom Cursor), and both mouse buttons to pan the view.

Controlling the Appearance of Objects

Display Object

You can control the display of each object independently using the **View | Display Object** option. The default for all objects is to be displayed (i.e. visible) in all Model windows. When a selected object is displayed, a check mark appears next to the Display Object command under the edit menu. You hide an object by first selecting the object either in the model window or the System Tree, then select **View | Display Object** or select Display Object from the pop-up menu, available by clicking the right mouse button in the model view or the System Tree. The object is no longer displayed and the check mark next to Display Object will disappear. The Display Object control affects the normal silhouette view, the rendered view, and the wireframe views.

To display an object that has been hidden, you must select the object using the System Tree. You can't use the model window because the object is hidden! After the object is selected, choose **View | Display Object** to redisplay the object. To turn on the display of all objects, use the **View | Display All** command, described below.

Display All

All objects can be made visible using **View|Display All**. This function will recalculate the silhouettes for the model view and redisplay the object in either the normal or rendered views.

Display Object WCS

All TracePro Objects use a working (local) coordinate system (WCS) which in turn is transformed from the Global Origin, displayed by the X,Y,Z axis. When moving the object, the Absolute position is defined relative to the Global Origin. The WCS display is enabled by selecting an Object and selecting the **View|Display Object WCS** menu.

Figure 2.33 shows a Reflector, Lens and Primitive Sphere with their respective WCSs displayed. The Reflector has its WCS origin at the vertex of the reflecting surface, the Lens has its WCS origin at the vertex of the first surface and the sphere has its WCS origin at the sphere's center.

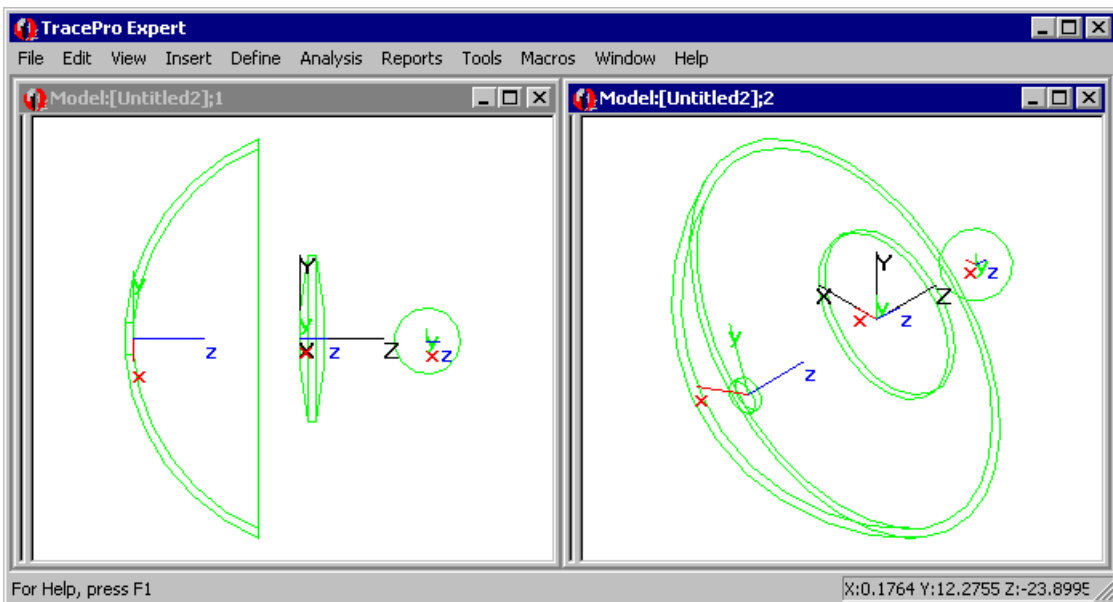

FIGURE 2.33 - WCS of three TracePro objects

Display RepTile Expert

The RepTile display option draws the virtual RepTile Geometry in the model window. To see the corresponding RepTile Geometry select **View|Display RepTile**. The boundary of the RepTiles as defined in the Apply Properties dialog is displayed along with the individual tile boundaries and geometry. See "RepTile Examples" on page 9.1. Textured RepTile is also viewed with this option. When RepTile Boundary Type: Use Surface Bounds is selected, there is no display of the RepTile boundary.

Figure 2.34 shows a block with a prism type RepTile surface. The RepTile property was applied with a Perfect Absorber surface property. A fan of rays is shown absorbed by the RepTile features in the central portion of the surface and leaving the block outside of the RepTile boundary.

NOTE: If the RepTile has a large number of tiles or features, the display may take a long time. You can interrupt the display of RepTile features by using the Esc key.

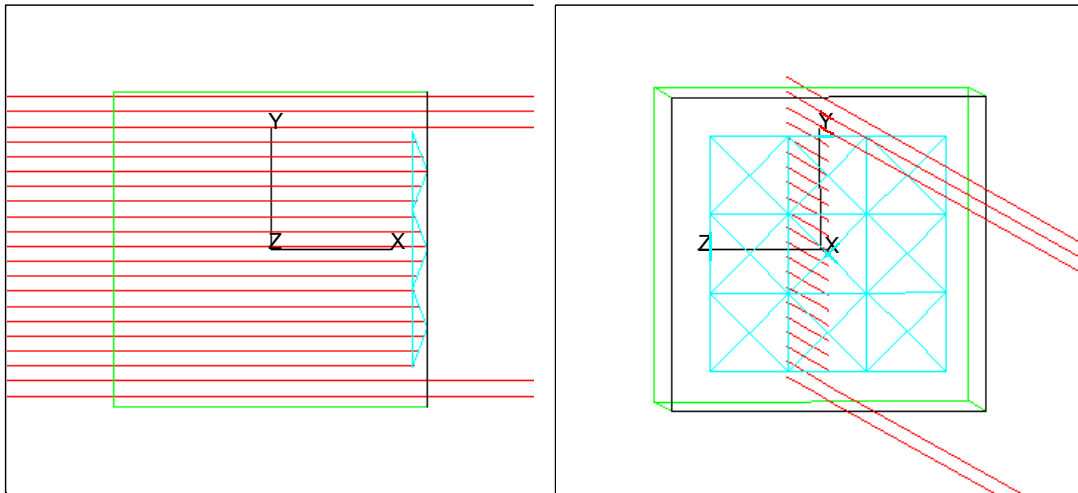

FIGURE 2.34 - Block with Prism RepTile surface displayed

Boundary Only

The **Display RepTile | Boundary Only** option is available for the instances when you wish to see only the boundary of the RepTile region without any of the feature information.

When RepTile Boundary Type: Use Surface Bounds is selected, this command has no effect.

Display voxels

Once either an audit or a raytrace has been performed on a model, the Voxels can be displayed by selecting **View | Display Voxels**. The Voxel Display can be turned OFF by reselecting this menu item to remove the checkmark.

Voxelization is a method of “allocating” the geometry in the model to specific zones to improve raytrace speed. Increasing the number of voxels improves raytrace speed at the expense of Audit speed and memory usage. Voxel settings are selected under **Analysis | Raytrace Options | Advanced**.

Display Importance Standard Expert

TracePro provides an option to display the size, orientation and location of surface and source Importance Targets in the model window. The display is enabled via the **View | Importance Targets** menu item. See “Importance Sampling” on page 7.2.

Figure 2.35 shows a lens with a single importance target displayed with IT at the target’s origin. One set of rays converges to the lens’s focus. Another set of rays converges to the importance target and are the importance sampled rays. Other rays are random scatter rays.

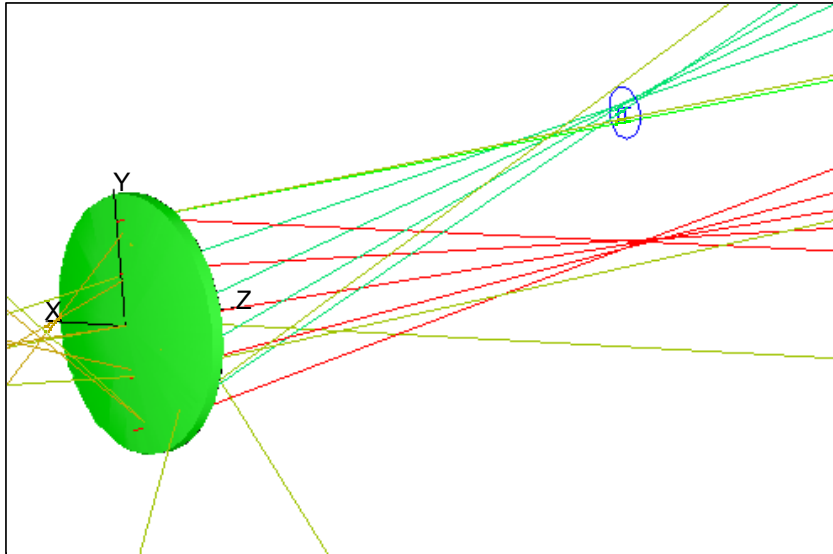

FIGURE 2.35 - Lens showing rays and importance target.

View Options

You can customize the operation of TracePro and change default settings using the **View|Options** menu selection, which opens a dialog box for changing the settings. See also “User Defaults” on page 1.11 about saving the default values used in dialogs.

General

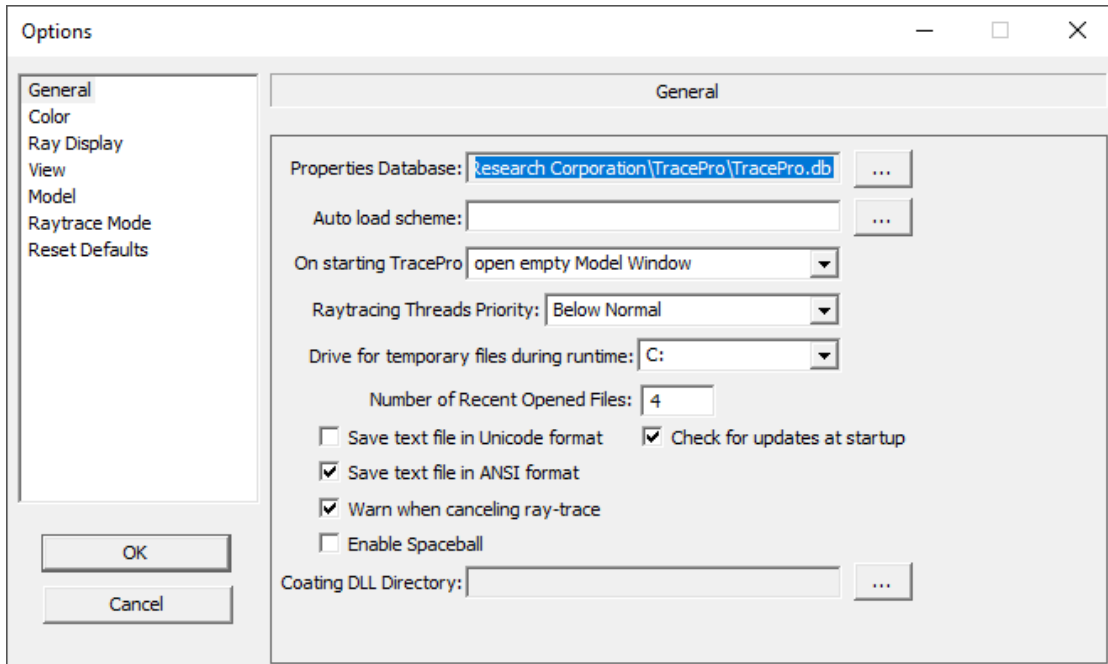

FIGURE 2.36 - View|Options, General tab.

Properties Database

This entry sets the location of the properties database file. You can set this by either typing in a new path and filename, or using the Browse feature to locate the database file. Properties are stored in a file that is initially installed with the name “TracePro.db”. You can copy the default database and build different data files with different sets of property data.

Auto load scheme

With the auto load macro you can load a file to set the options and functions you wish without calling **Macro|Execute**. See “Macro Programs” on page 8.7.

On Starting TracePro

The opening of model windows upon starting TracePro can be set to any of four options:

- Open empty model window
- Open most recently edited model
- Prompt to open most recently edited model
- Don't open any model window

Raytracing Threads Priority

You can select the priority for the TracePro process. If you need to do other tasks while TracePro is running, use the default Below Normal or Low.

Drive for temporary files during runtime

TracePro creates and uses temporary files during a Simulation Mode ray-trace. These files are saved on the C: drive and deleted after the ray-trace is finished. For a large ray-traces, the files may be very large. If you do not have enough free disk space on you C: drive, choose a drive with more free disk space.

Number of recent opened files

This selection sets the number of recent files displayed at the bottom of the File|Open dialog box.

Save Text File Format

You can save text files in one of two formats: Unicode or ANSI. Unicode format is for those who need access to the wide character set that introduces characters that are not in the Roman alphabet (e.g. from African, Asian, and Middle Eastern languages). Note that if you use only the standard ASCII character set, then you will likely prefer the ANSI format. Also, the Unicode format requires approximately twice the file size as ANSI.

Check for updates at startup

If this selection is checked, TracePro will query the Lambda Research web site for a newer release of TracePro. If your support subscription entitles you to this newer release, TracePro will invite you to let it download and install the release automatically.

Enable Spaceball

Support for Spaceball input devices is available. Do not enable the Spaceball mode without the proper device drivers.

Warn when canceling raytrace

If this selection is checked, TracePro will warn you each time you cancel a raytrace, that the raytrace cannot be resumed later.

Coating DLL Directory

This entry sets the directory that may be used when writing your own Coating DLL. You can set this by either typing in a new path and filename, or using the Browse feature to locate the directory. If you leave this entry blank, TracePro uses the Windows default directory as the Coating DLL Directory.

Color

Background colors

These items select the background colors for the Model Window, System Tree and Dialog Evaluators. Click in the color to display the Color Palette to change the selection. See "Expression Evaluator" on page 1.15.

The Model Window can have two colors defining a color gradient from the top of the window to the bottom. If both colors are the same, no color gradient is used.

Object/Surface colors

These items select the colors used when an object is created in TracePro and when an object or surface is Highlighted after it is selected. Click in the color to display the Color Palette to change the selection.

Ray Display

Set default for menu: Analysis|Display Rays

This selection sets the default condition for the **Analysis|Display Rays** menu item in any new models that are created. After a raytrace with a large number of rays, this may take several minutes and consume too much memory, so this feature allows you to disable automatic drawing of rays. The control of whether rays are displayed for the current model is still controlled from the **Analysis|Display Rays** menu item directly.

The Display ray direction arrows

This checkbox controls whether small arrows are attached to each ray segment indicating the direction of propagation. The option is global to all active Model Windows. Checking Display ray direction arrows enables the option, as shown below.

Display non-intersecting rays

This option is the default case in TracePro and is the mode for older releases. By turning off this option, TracePro will ignore rays that do not have a surface intersection. Rays which leave a surface source, start from a ray grid or file source are considered non-intersecting if they leave the model space without hitting any surfaces.

Enable start ray drawing limit

If this option is checked, you can enter a number of starting rays to draw and TracePro will only draw segments for the rays with start ray numbers less than the number entered. If Ray Sorting is used, only rays in the Sorted set with start ray numbers less than the number entered will be drawn. Start ray numbers are displayed in the Incident Ray and Ray History tables.

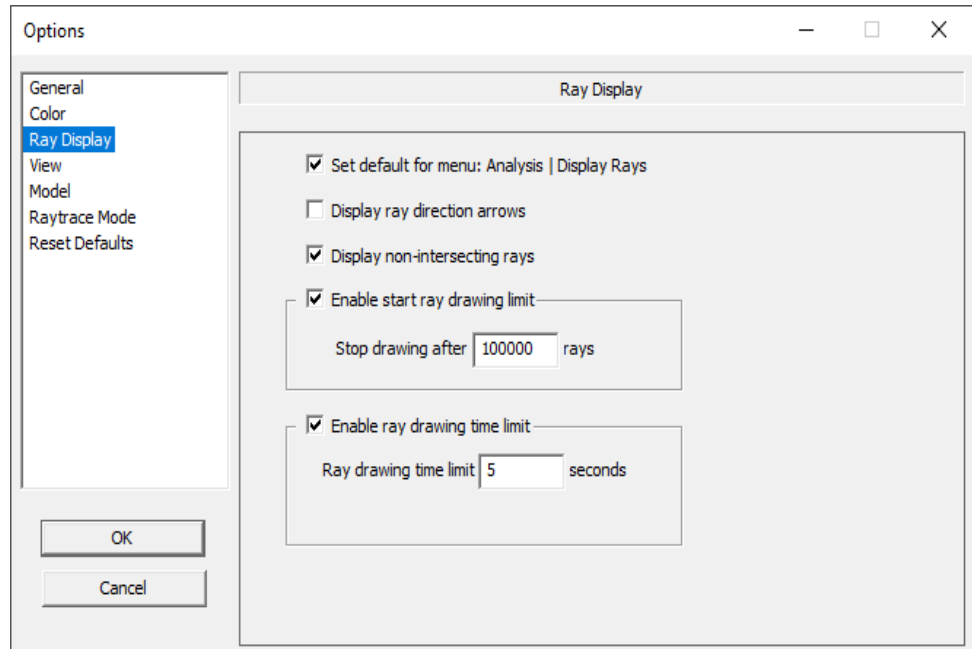

FIGURE 2.37 - Options dialog window with the Ray Display pane chosen.

Enable ray drawing time limit

When this selection is enabled, the rays in the Model Window will only be drawn for the number of seconds specified. Note that after the *Ray drawing time limit* has been changed in the **View|Options** dialog, the rays in the Model Window will not automatically redraw. In order to keep TracePro from starting a possibly time consuming procedure, **Analysis|Ray Sorting** must be updated or the Model Window must be resized in order to trigger the redrawing of rays in the Model Window.

View

Placement of System Tree

This item sets the location of the splitter window for the System Tree. It can be located either on the right or left side of each model window.

Open System with xx% of the Model Window

The *Open System tree* option is used to automatically display the system tree when a Model Window is opened. The value entered is a percent (0 - 100) of the Model Window size.

Prompt before entering Simulation Raytrace

The *Prompt before entering Simulation Raytrace* box, checked by default, can be unchecked to allow you to run repeated raytraces in a scheme macro without any user interaction.

Display Importance Target Labels

Display Importance Target object/surface label controls the labels when Importance Target display is on. See “Display Importance” on page 2.55. The labels can be turned off if they clutter the view. When the labels are displayed the font size can be changed to improve the visibility of the labels.

Importance Target label font size

This entry sets the font size of the Importance Target labels.

Default model view

This control sets the default view orientation when opening models or creating new models.

Zoom parameters

The Zoom parameters let you control the zooming functions. The Zoom in by: and Zoom out by: entries control the zooming factors for the **View|Zoom In** and **View|Zoom Out**, and the Zoom In and Zoom Out buttons. The Wheel zoom factor is used to control the zooming when using the mouse wheel.

Checking the *Single use zoom window* check box causes the Zoom Window mode to be turned off after one use of Zoom Window. The Zoom Window button also becomes unpressed. In order to do another Zoom Window, you must select Zoom Window again.

View rotation

The view direction in the Model Window can be rotated using the arrow keys on your keyboard. This control allows you to set the rotation angle that occurs with each keypress.

On opening models

When opening models, you can set TracePro to display all objects, or display only objects that are set as visible (i.e. not hidden).

Model

TracePro lets you choose the linear units you prefer to use with the model geometry. Available units are millimeters, centimeters, meters, and inches. Select **View|Options** and choose the Model pane of the dialog box. Select your preferred units via the drop-down list and click *Apply*. The model dimensions are translated into the selected units. The selection applies to the current model. The program default is that new models are created in millimeters. See “Model Units” on page 2.1.

Getting a Model into the Proper Units

When importing geometry from outside of TracePro it is important to verify that the model geometry is in the proper linear units before subsequent optical analysis is performed. Most computer programs allow you to specify these units and the data transfer into TracePro will be correct. Where this is not the case, TracePro can easily make these adjustments so you may proceed with your analysis.

Here is a recommended sequence of steps to accomplish this in TracePro:

1. After importing the model, determine which units you are currently viewing the model in. This information is available in the status bar at the bottom of the TracePro window whenever the mouse cursor is in the model view.
2. If you wish to work in units other than the ones shown, select **View|Options** and choose the Model pane of the dialog box. From the drop-down list select the linear units you desire and click Apply. (Verify that you are now viewing the model in these newly selected units.)
3. Now look at the magnitude of the numbers. Are they correct? Are they too large or too small? A scale factor needs to be determined to properly scale the entire model. (i.e. all the objects)
4. Hint: Most computer programs use millimeters, centimeters, inches, or meters to specify their geometry, so the desired scale factor is usually 10, 100, 1000, 2.54, 25.4, or the reciprocals of these numbers, as these scale factors represent the scaling between these units of measure.
5. If the dimensions of objects in the model are not correct (this can happen if the units were not specified in the imported CAD file), select all the objects in the model (See “Selecting Objects and Surfaces” on page 1.11.) and select the **Edit|Object|Scale** menu item. Enter the appropriate scale factor in the Scale Selection dialog box and click Apply.
6. Verify your work and save the file. You are now ready to proceed with your analysis.

Default Temperature Standard Expert

The Default Temperature for the current model can be specified in this dialog. This temperature is effectively applied to all objects and surfaces in the model that do not specifically have a temperature applied (**Define|Apply Properties|Temperature**). For more information on the application of Temperature Properties, See “Temperature” on page 4.36.

Environment

The Material Property and Bulk Scatter Property of the Environment can be changed. The Material Properties and Bulk Scatter Properties in the user’s database can be applied. The Environment is all of the space that is not inside of and object.

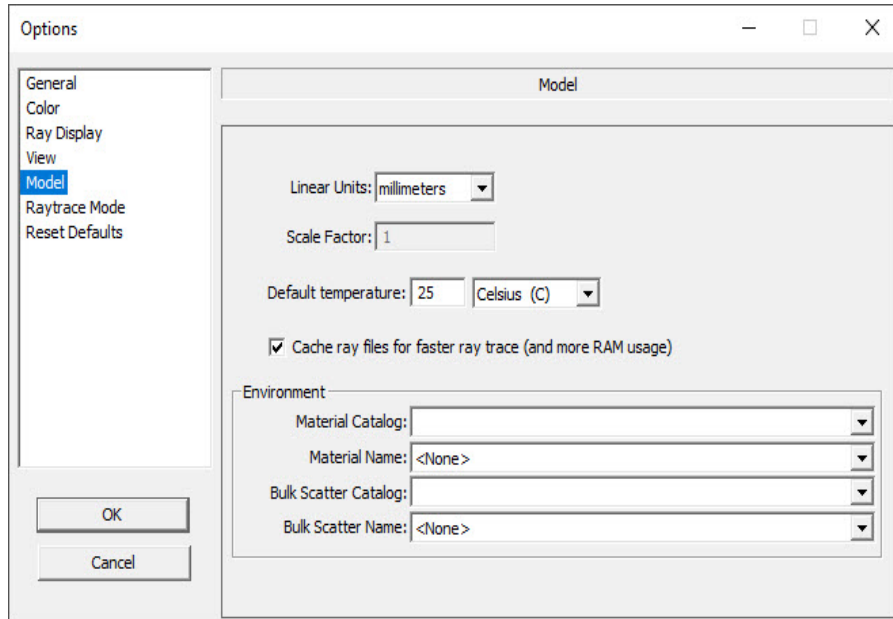

FIGURE 2.38 - Options dialog window with the Menu pane chosen.

Raytrace Mode

To change the default raytrace mode for new models, i.e. either *Analysis Mode* or *Simulation Mode*, select **View|Options|Raytrace Mode**. Here you can also control whether the prompt for *Raytrace Mode* appears before starting each raytrace.

Reset Defaults

You can reset the default values for dialog box entries using this page. Use this option if you have changed any default values using the *Set Defaults* button found in various dialog boxes, and you wish to revert to those present when TracePro was first installed. You can reset default values for each dialog box individually, or for all dialog boxes at once using the *Reset All Above Default Values* button.

Changing Colors

A color selection dialog is used to specify the default object color, model window highlight selection, window backgrounds, and dialog evaluator controls. The dialog displayed in Figure 2.39 is consistently used through TracePro.

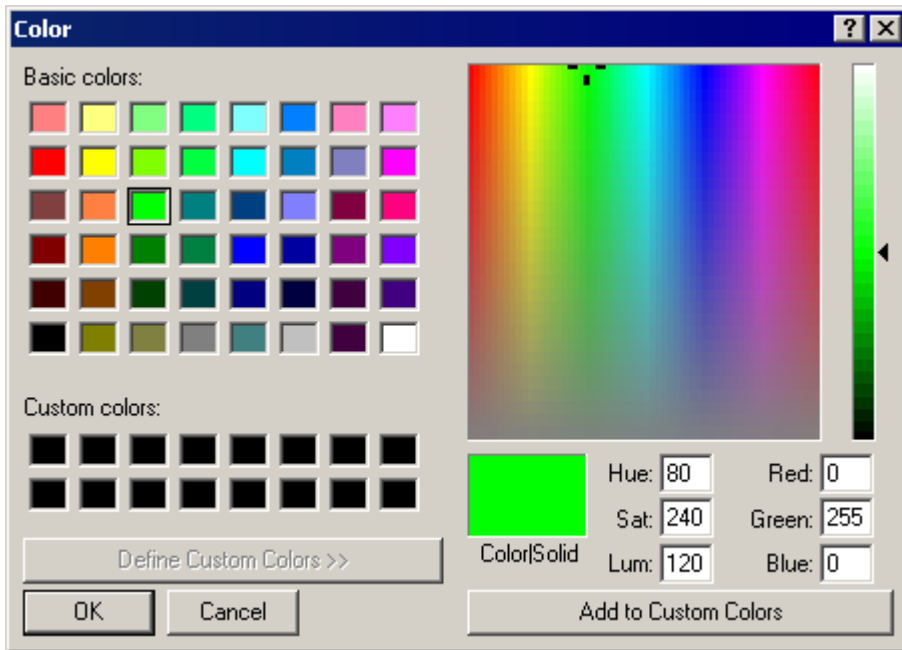

FIGURE 2.39 - Color selection dialog

Color can be selected from the palette or using the Custom Colors interface. After a custom color is selected, press *Add to Custom Colors* to store the new color definition.

Photorealistic Rendering

You can create a photorealistic rendering of your model to see how it looks with TracePro properties applied. You can see how your model looks with the surface sources you have defined, or add ambient luminance. If you just want to see what the model looks like, you can use ambient luminance only. Use Photorealistic Rendering with or without ambient luminance to get an impression of the “lit appearance” of your model, i.e. to see how it looks with lights sources turned on.

You should use Photorealistic Rendering only after completing setup of your model sufficient for tracing rays. The Photorealistic Rendering will use the TracePro properties, surface sources, and ray-trace settings you have defined for your model.

The rendering process consists of a forward ray trace, which defines a photon map, followed by a reverse ray trace to build the rendered image. The forward trace uses the photons stored in the photon map to evaluate relative luminance in the scene. When you start a rendering calculation, you will see a Progress Dialog Box for the forward ray trace, followed by another Progress Dialog Box for the reverse ray trace.

To set up and calculate your rendering, follow these steps:

1. Select **Raytrace|RayTrace Options**. On the **Thresholds** tab, set the **Flux Threshold** to 0.001 as a first guess. On the **Advanced** tab, set **Voxel Parameters** to **Fastest Raytrace**. If your model uses Octree Voxels, set the parameters for a fast ray trace.
2. Select **View|Photorealistic Rendering>Setup**, and choose **Rendering Quality = Low** as a first guess. Set **Ambient Lumiance** as you desire.
3. Set the **Model Window** to the orientation you wish to render, and set the window size relatively small for a faster rendering.
4. Select **View|Photorealistic Rendering>Render** to begin the rendering. A new window will open that is the same size as the model view, and the forward ray trace will begin, followed by the reverse ray trace. The time to finish the rendering may be minutes to hours, depending on the complexity of the model and properties, the size of the **Model View** window, the flux threshold, the **Rendering Quality** setting, and the number of processors available on the computer. You can stop the rendering at any time to see a partial result.
5. Once the rendering is completed, you can adjust the brightness, contrast, and gamma using **View|Photorealistic Rendering|Options**.
6. Adjust the flux threshold up or down to trade accuracy for speed, as you would for a normal ray trace.
7. Adjust the **Rendering Quality** setting for more rendering passes (i.e. more rays/pixel) to improve the rendering quality. Each Rendering Quality setting traces 10 times more rays/pixel than the next lower setting.

Hint: Once you have the **Model Window** set to a view that you like, use **View|Named Views** to save the view for ease in repeating the rendering at a later time.

Limitations of Photorealistic Rendering in TracePro are as follows:

1. Dispersion is not modeled. This means that, for example, separation of colors by a prism or grating is not modeled. Effective index of refraction of transparent materials is computed as the average index across the visible spectrum, weighted by the photopic efficacy. Diffraction, if specified, is computed at wavelength 0.55 μm for all colors.
2. Polarization is not modeled. If you begin a rendering with polarization on (according to the setting in **Raytrace|Raytrace Options, Options** tab) TracePro will change the polarization setting to unchecked before beginning the rendering.
3. Coating DLL surface properties are not modeled.
4. Coating Stack surface properties are not modeled.
5. Bulk Scatter DLL properties are not modeled.
6. Grid Sources are not modeled.

Photorealistic Rendering Setup

The settings in the Photorealistic Rendering Setup dialog box let you control the ambient lighting in the rendering, and trade off rendering quality with time to render. Specify these parameters before beginning a Photorealistic Rendering. Select **Photorealistic Rendering|Setup** to set these values.

Ambient Luminance

The **Ambient Luminance** setting allows you to add background light so you can better see the objects you are rendering.

Specify the **Ambient Luminance** by specifying the luminance in cd/m² (nit). You can choose from the available luminance values for **Outdoor** and **Office**, or enter your own luminance value by choosing **Custom**.

Lighting in the photorealistic rendering will be comprised of the surface sources in the model plus the ambient luminance. The source of the ambient luminance is a virtual hemisphere. The ambient luminance is effectively emitted from the inside of the hemisphere. The (X, Y, Z) values for the **Ambient Lighting Direction** specify a vector pointing towards the pole of the hemisphere. For example, if your model has the y axis as the "up" direction in your view, and you want ambient lighting coming from above, specify (0 1 0) for the (X Y Z) ambient lighting direction vector.

Rendering Quality

There are five different quality settings for the rendering:

- Low
- Medium
- High
- Extra High
- Extremely High

Each higher setting takes roughly ten times longer to render than the previous setting.

For a quick view of the rendering when some noise is acceptable, choose **Low**.

For many applications, the **High** setting will be sufficient to get a satisfactory rendering.

If the design is inefficient or otherwise difficult to simulate, you may need to use the higher settings.

Max Photons To Trace

TracePro uses the technique of Photon Mapping to compute a Photorealistic Rendering. This is comprised of a forward ray trace or photon trace (rays emitted from light sources) followed by a reverse ray trace (rays emitted from the eye point). The forward ray trace generates a photon map, which is then evaluated during the reverse ray trace to produce the rendered result. A good rendering requires adequate sampling in the photon map, followed by adequate sampling in the reverse ray trace. The sampling in the photon map is controlled by the **Max Photons To Trace** setting. In most cases you should leave this setting at 0, and let TracePro determine the optimal number of photons to trace.

Photorealistic Rendering Options

Once your rendering is completed, you can control the appearance of the rendering using Photorealistic Rendering Options. To open the Photorealistic Rendering Options dialog box shown in Figure 2.40, select

View | Photorealistic Rendering | Options, or right-click on the completed rendering and select *Photorealistic Rendering Options*. The options allow you to adjust Brightness and Contrast from 0 to 1 and Gamma from 0-3 for the rendered image.

Normalize to: has 3 options: *None*, *Highest Color*, and *Exposure Level*. Selecting *Highest Color* will normalize the displayed color value in the plot. Selecting *Exposure Level* will normalize the plot to display a saturated white color, even if the plot is monochromatic. For example, with green light the saturated values would be (0,255,0).

Saturated Color allows you to turn the Saturated Color on or off. The RGB values can range from 0-255. Saturated Color shows any pixels where any of the RGB values are 255. You can change the color for saturated pixels by clicking on the color bar.

Value mode has two options, Raw value and Integer. This setting controls the values displayed in the Status Bar when you move the mouse pointer over the map or rendering. The Raw value displays the floating-point RGB values in the Status Bar as calculated by TracePro to create the True Color image. When Integer is selected, the actual integer values used in the image (0-255 RGB) are displayed.

If Normalize to: is set to *Exposure value* and the *Calculate exposure compensation* box is checked, the *Exposure compensation* value for saturated white will be calculated automatically. If the *Calculate exposure compensation* box is not checked, an *Exposure compensation* value can be manually entered.

In Photorealistic Rendering, the approximate luminance in cd/m^2 is displayed as a fourth value in the Status Bar.

Displaying approximate luminance

You can also display the approximate luminance values as determined by the rendering algorithm. Select *Map Type: Luminance* to unlock the controls for:

- *Color Scheme* - Grayscale or Color (Rainbow)
- *Log scale* - logarithm of luminance will be displayed
- *Show Legend* - draw a legend inside the rendering window
- *Set Max* and *Set Min* - set the minimum and maximum luminance values to be displayed.

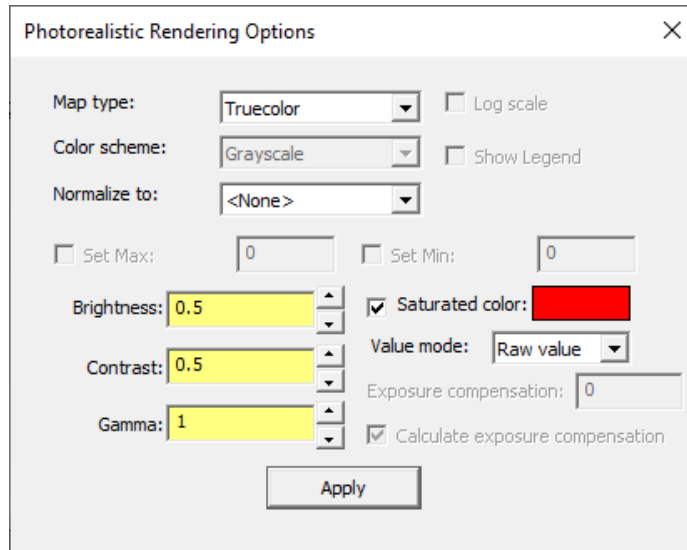

FIGURE 2.40 - Photorealistic Rendering Options

Photorealistic Rendering with Fluorescence

TracePro can perform Photorealistic Rendering using fluorescence generated File Sources. There are several steps to follow in order to accomplish this.

1. Turn Fluorescence On at **Raytrace|Raytrace Options|Options**
2. Select *Insert file source* in the same dialog box
3. Select *Generate emission source only* from the dropdown menu
4. Run the raytrace
5. Turn off Fluorescence at **Raytrace|Raytrace Options|Options**
6. Turn off the excitation light source in the Source tree
7. Run the Photorealistic Rendering as described above
8. Please note that you will need to trace a large number of rays to get a good quality result

Overview

What is a property?

Properties are modifiers to objects and/or surfaces that determine how rays will interact to these objects. Examples of properties include materials, surface finishes, temperature, light source, and transmission characteristics. There are pre-defined properties, but you may also define your own.

Define or Apply Properties

This chapter covers defining custom properties that you can use in your model. Typically, you need to “define” properties before you can “apply” them. However, in order to define properties correctly, you will need measured data for the properties you wish to define. For instance, if you have a special paint that you want to use on a given surface of your solid model, you must have the properties of that paint measured before you define TracePro properties for it.

If you plan on using only the pre-defined properties in the TracePro databases, you should just read the first few sections of this chapter and refer to Chapter 4, “Applying Properties”.

You can come back to this chapter when you need to define custom properties. The remainder of this chapter assumes that you have already read about applying properties in Chapter 4. Properties are defined using Property Editors. Selecting **Define|Edit Property Data|Material Properties**, for example, opens a new window for creating and editing material properties. All property editors work in this way.

Property Editors

TracePro property editors share common features described in this section. Each editor is comprised of a Command Panel, Information Panel and Grid Panel.

The Material Property editor is shown in Figure 3.1 with the Command Panel on the left, the Information Panel on the top and the Grid Panel on the bottom. Toolbar buttons are provided to hide editor tabs to expand the tab of interest. For Material Properties, the data tab is split between the Table view for tabular input and the Formula view for interpolation coefficients. The tool bar includes lock/unlock icons used to enable editing.

The Surface Property editor is shown in Figure 3.2 with several columns collapsed and the data context contextual popup menu displayed. In addition to the other general changes, individual rows of data in the Surface Property editor may use the Solve For function on a row by row basis from the popup menu.

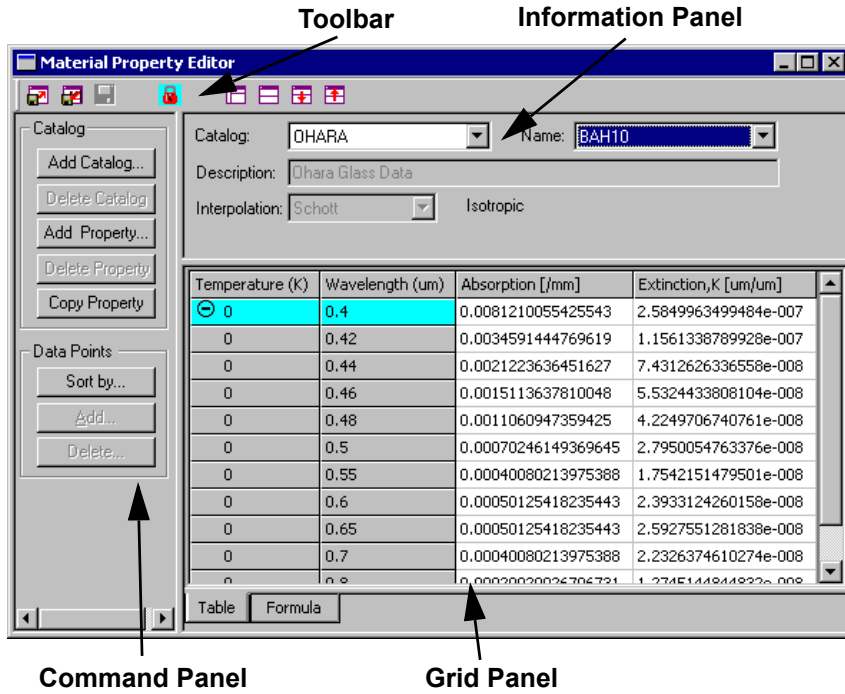

FIGURE 3.1 - Material Property Editor

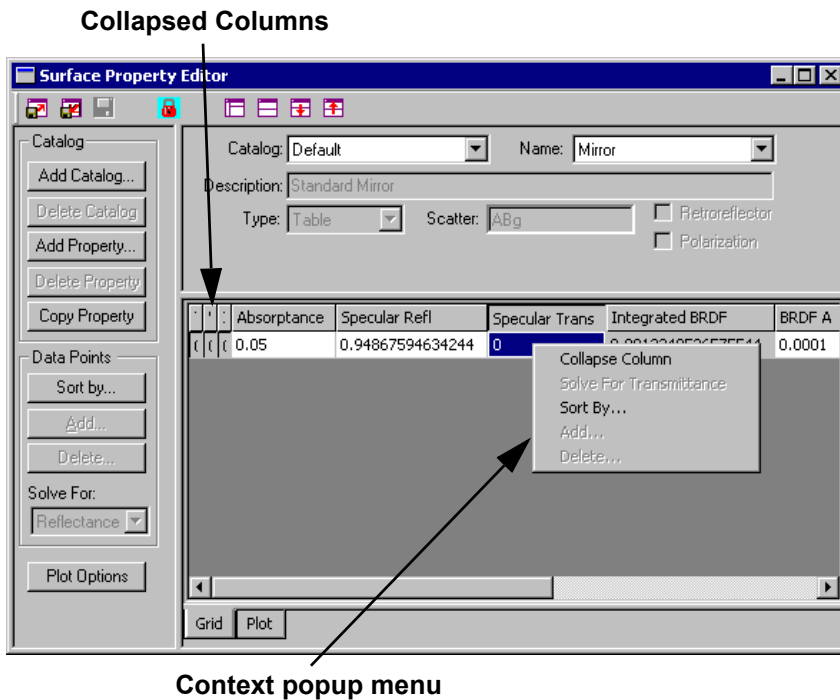

FIGURE 3.2 - Surface Property Editor with a cell popup menu

Toolbars and Menus

Each tool bar icon has a corresponding Menu item.

TABLE 3.1. Editor menu and toolbar commands

Menu	Toolbar	Description
File Import Property		Import property data from ASCII file
File Export Property		Export current property to ASCII file
File Save		Save current property data
Edit Lock Property		This icon indicates that the current property is in Edit Mode, selecting the menu or pressing on the icon will place the property in Locked mode and disable further editing
Edit Unlock Property		This icon indicates that the current property is in Locked Mode, selecting the menu or pressing on the icon will place the property in Edit mode and permit modification of the data
View All Panels		This selection exposes the three tabs or panels in the editor
View Info & Grid		This selection hides the Command tabs to maximize the width of the Information and Grid tabs
View Info Only		This selection maximizes the Information tab
View Grid Only		This selection maximizes the Grid tab
(no menu)		The Expand icon is displayed when a set of rows is collapsed. Double Clicking on the icon will restore the rows
(no menu)		The Collapse icon is displayed when the row is followed by rows with the same data value. Double Clicking on the icon will hide the subsequent rows

Command Panel

The Command Panel provides buttons to work with Catalogs, Properties and Data. The Command Panel is located on the left side of the editor in a split window tab. The width of the tab may be set by dragging the splitter bar. Some of the options will vary depending on the type of property being viewed.

TABLE 3.2. Command Panel buttons

Add Catalog	This button displays a dialog asking for the name of a new catalog. The new catalog will begin empty and become the current catalog in the editor.
Delete Catalog	This button deletes the current catalog from the TracePro database file. A Warning dialog is displayed. Once a catalog is deleted it can not be retrieved. See “Properties Database” on page 2.57.
Add Property	This button displays a dialog asking for a property name and other initial property data. The property will be added to the current catalog.
Delete Property	This button deletes the current property from the catalog. A Warning dialog is displayed. Once the property is deleted it can not be retrieved.
Copy Property	This button prompts for a new catalog and property name. The data is copied causing a new property to be added to the selected catalog.
Sort by...	This button displays the Sort Dialog. Properties with two or more dependant variables can be sorted based on a selected order of variables. For example, Material properties with tabular data may be sorted by Temperature then Wavelength or by Wavelength then Temperature.
Add...	<p>This button displays the Add Data Dialog. One or more rows of data will be added to the property for the value entered in the dialog.</p> <p>The Add function automatically creates all the necessary rows to keep each temperature, wavelength, and incident angle consistent (i.e., you need all the data for each sortable index).</p>
Delete...	This button displays the Delete Data Dialog. You can select one or more values to delete from the property and the selected rows will be highlighted. Once the data is deleted it can not be retrieved.
Solve For:	Surface Properties have an option to solve for one data value based on the the values of the other data items. The Solve For list is only visible in the Surface Property Editor and works over the entire dataset. To solve for an individual row, select the value to solve and use the popup menu. See “Using Solve for” on page 3.27.
Plot Options	Surface Properties have an Plot view in the Grid Panel. The Plot Options are used to control the data displayed in the plot. See “Surface Property Plot Tab ” on page 3.30.

Information Panel

The Information Panel is located in the top, right tab of the editor. This panel displays the Catalog and Name of the property, a description and other general property data. Some pre-defined properties are read only, and thus you cannot change them. These properties are maintained by Lambda Research. If you wish to modify a read-only property, make a copy using the Copy Property function, and modify and apply the copy.

Grid Panel

The Grid Panel, or Data Panel, is located in the lower, right tab of the editor. This panel displays tabular data and coefficients. In some cases the data is divided into two or more tabbed tabs as shown in Figure 3.1 on page 3.2. The Grid contains spreadsheet tables with context sensitive popup menus for most of the data cells. Rows and columns may be collapsed to hide some data, exposing other cells. Clicking on a column heading will collapse or un-collapse that column. Rows may also be sorted to view the data in different ways to made editing more convenient. Row sorting is accomplished by pressing the Sort by... button in the Command Panel area or by right clicking on the tabular data in the grid and selecting Sort by.

Material Properties

The material property (of an object) in TracePro specifies the index of refraction and the bulk absorption. To use a material property, select the **Define|Apply Properties** dialog box, then select the tab labeled “Material.” See “Material Properties” on page 4.4.

Material Catalogs

Several catalogs of manufacturer data come with TracePro. You can also add your own catalogs and materials. These catalogs and materials will then appear as options within the Information Panel selections.

Material Property Database

A database exists containing predefined material catalogs and materials. You can choose among them or you can add or modify user-defined materials by using the Material Property editor.

You can add or modify materials in the Property Database by selecting **Define|Edit Property Data|Material Properties**. This opens a new window in TracePro, not just a dialog box like many other features.

The Material Property editor allows you to modify the name, interpolation type, description, temperature and wavelength of certain materials. Some pre-defined material data supplied with TracePro is Read-Only and cannot be edited.

A spreadsheet-like window displays the index and absorption coefficients when interpolation is by interpolation formulae, or wavelengths and index values for tabular data. Absorption coefficient data may be entered as α in units of 1/mm, or k , which is dimensionless. See Equation 3.4 on page 3.8.

Selecting a catalog and entering a material name or selecting one from the list causes TracePro to display the data for that material in the editor window. You can add new materials and catalogs by using the respective Add buttons in the editor window Command Panel. Ten interpolation formulas are available for material property data. You must choose the interpolation type when using the Material Property editor. For example, Figure 3.3 on the next page shows the Formula tab for entering the coefficients for the Sellmeier interpolation method.

Note: The Properties editors are different from most features in TracePro because each one is a window rather than a dialog box. The menu bar displays a different set of options when you are in the editor window. If you are in the editor, you can return to the model window by selecting the model item from the Window menu.

TABLE 3.3. Fields used in the Material Property Information Panel

Catalog	Selects a Material property catalog.
Name	Material property name selection box. The name can be selected using the drop down arrow or by typing the name into the text box. If the name is found in the database its data will be displayed.
Description	The description contains notes about the Material Property.

Interpolation	Selects the interpolation method. Schott, Sellmeier, Extended Schott, Table and other interpolation methods are available. See “Material Property Interpolation” on page 7.7.
Type Expert	The type of property is displayed next to the Interpolation method. The available types are Isotropic and Uniaxial. Isotropic properties have a single refractive index and Uniaxial properties are Birefringent. The type is set in the Add Property dialog when the property is originally defined.

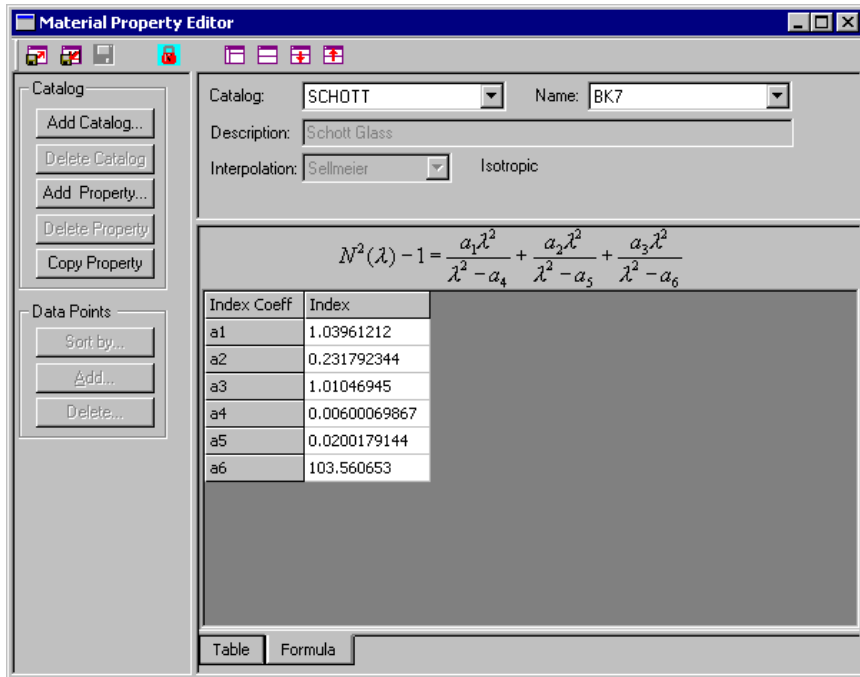

FIGURE 3.3 - The Material Property Editor

Create a new material property

The steps listed below show the method to create a new property within Material Properties.

1. Select **Define|Edit Property Data|Material Properties** to open the Material Property editor.
2. Select a catalog, using the dropdown catalog list, into which your new material property is to be added. Add the material to an existing catalog or use the *Add Catalog* button to create your own.
3. Click the *Add Property* button, enter a name for your new property and click OK. For users of TracePro Expert also select if the material is isotropic (i.e., single refractive index) or uniaxial (i.e., birefringent).
4. Select the interpolation type. If not tabular data, click on the Formula tab at the bottom of the Grid Panel area and enter the values for that equation. There is more information on this subject in “Material Property Interpolation” on page 7.7.
5. Click the Table tab and use the *Add* button to add absorption data or tabular index data at multiple wavelengths. This data is in spreadsheet-like format.



6. You can edit the values that define the property simply by selecting a cell or field and entering your numbers. Be sure, however, that the Unlock Icon is displayed in the Toolbar.
7. Select **File|Save** or close the Material Property editor and answer yes to the question, “property data has changed, save data?” Your new property is available in the database for future use the next time you access your property.

Editing an existing material property

The steps listed below show the method to edit an existing property within Material Properties.



1. Select **Define|Edit Property Data|Material Properties** to open the Material Property editor.
2. Choose a catalog from the catalog dropdown list.
3. Choose the name of your property from the name dropdown list.
4. Click the Lock icon in the Toolbar to enable editing. You cannot make changes to a property that is Read Only. Pre-defined manufacturer properties cannot be edited unless you export them to text format, change their status to user defined, and re-import them into TracePro. See “Material Property Format” on page 7.93.
5. Edit the values that define a property by selecting a cell or field and entering your data.
6. Select **File|Save** or close the Material Property editor and answer yes to the prompt, “Property has changed, save data?” The edited property is now available in the database.

Exporting a material property

The steps listed below show the method to export a property within Material Properties.

1. Select **Define|Edit Property Data|Material Properties** to open the Material Property editor.
2. Choose a catalog from the dropdown list of catalogs.
3. Choose the name of your property from the dropdown list.
4. Use the **File|Export Property** command to create a text file that contains the information for the selected property. See “Material Property Format” on page 7.93. The exported file is a tab-delimited text file that can be opened with a spreadsheet program.

Importing a Material Property

The steps listed below show the method to import a property into Material Properties.

1. Select **Define|Edit Property Data|Material Properties** to open the Material Property editor.
2. Use the **File|Import Property** command to import a text file (in the proper format) that contains the information for a material property. You will be prompted to enter the name and location of the text file. The property is saved upon importing.

Bulk Absorption

The units for the absorption coefficient are 1/mm. Rays that enter a material with non-zero absorption coefficient are attenuated according to Beer-Lambert law of transmission,

$$\Phi_T = \Phi_0 e^{-\alpha t}, \quad (3.1)$$

where Φ_T and Φ_0 are transmitted and incident flux, α is absorption coefficient, and t is the thickness of material through which the ray travels. The flux absorbed by the material is then

$$\Phi_A = \Phi_0(1 - e^{-\alpha t}). \quad (3.2)$$

Note: When entering bulk absorption for materials defined using the table interpolation type, remember that bulk absorption is in units of inverse millimeters. Table 3.4 illustrates use of Lambert's law for two samples at 1 and 2 mm thickness.

TABLE 3.4. Bulk Absorption in Inverse Millimeters

Absorption Coefficient	Transmission through 1 mm	Transmission through 2 mm
0.0001	0.9999	0.9998
0.001	0.999	0.998002
0.01	0.99005	0.980199
0.1	0.904837	0.818731
1	0.367879	0.135335

Note: Absorption data is saved in terms of α in the database. α is in units of inverse mm. You can also enter the data using the Extinction coefficient, k , which is a dimensionless quantity that comes from the complex index in Equation 3.3.

$$N = n + ik \quad (3.3)$$

k and α are related via the following:

$$\alpha = \frac{4\pi k}{\lambda}. \quad (3.4)$$

When converting k to and from α , you must be careful to use λ in millimeters.

Birefringence Expert

When a ray passes through a birefringent media, the ray is split into an ordinary and an extraordinary segment. Birefringent properties are labeled as Uniaxial and require additional information to define two sets of index and absorption data, one for the ordinary and one for the extraordinary ray.

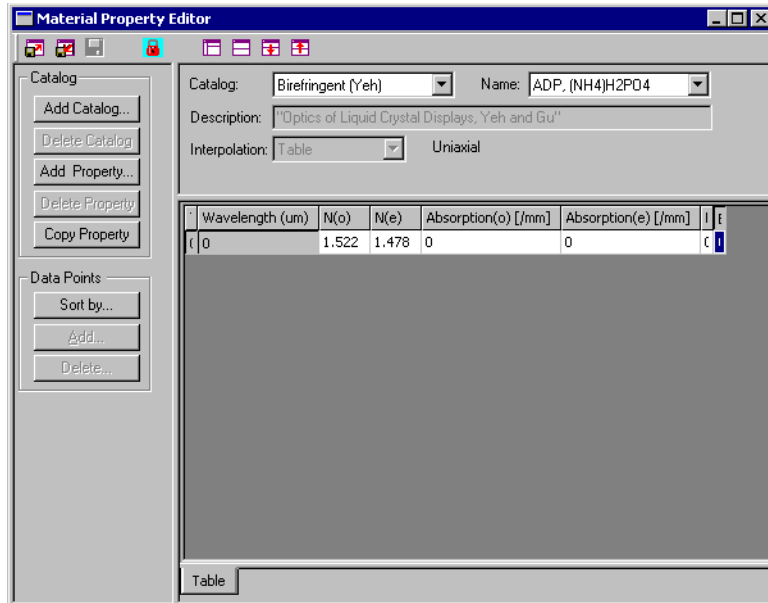

FIGURE 3.4 - Material Editor for a Birefringent Property

For information on birefringent materials see:

- M. Born and E. Wolf, “Principles of Optics”, Pergamon Press, sixth edition, chapter 14 (1980), ISBN: 008026481
- P. Yeh and C. Gu, “Optics of Liquid Crystal Displays”, John Wiley & Sons, chapter 3 (1999), ISBN: 047118201X
- E. Collett, “Polarized Light”, Marcel Dekker, Inc., chapter 23 (1993), ISBN: 0824787293

Bulk Scatter Properties Standard Expert

The Bulk Scattering Property Editor is used to:

- Edit properties that are stored in the bulk scatter property database.
- Create new properties for addition to the bulk scatter database.

One scattering distribution function (SDF) that has been implemented in TracePro is based on a paper by Jacques and Wang¹ that describes scattering in biological tissue and uses the Henyey-Greenstein model. Equation 3.5

1. S. L. Jacques and L.-H. Wang, “Monte Carlo modeling of light transport in tissues,” in Optical Thermal Response of Laser Irradiated Tissue, edited by A. J. Welch and M. J. C. van Gemert (Plenum Press, New York, 1995), pp. 73-100.

$$SDF = p(\theta) = \frac{1 - g^2}{4\pi(1 + g^2 - 2g \cos \theta)^{3/2}} \quad (3.5)$$

where g is called the anisotropy factor, and g can take on values between -1 and 1 . When g is positive, rays are scattered more in the forward direction, and when g is negative, they are scattered more in the backward direction. When g is zero, the scattering is isotropic, i.e. the same in all directions. See “Bulk Scattering” on page 7.61.

When a ray enters a scattering medium, it propagates a random distance x governed by the probability distribution

$$P(x) = e^{-\mu_s x} dx \quad (3.6)$$

where μ_s is called the scattering coefficient. The inverse of the scattering coefficient is the mean free path of the ray in the material. When a ray enters a piece of material that is thin compared to the mean free path, it is likely to pass through the material without being scattered. Conversely, if the material is thick compared to the mean free path, the ray is almost certain to scatter within the material. When a strong scattering coefficient is combined with a strong absorption coefficient, rays will be only weakly transmitted through the material.

A second SDF is available called the Gegenbauer model. The Henyey-Greenstein² is a special case of the Gegenbauer model setting α to $1/2$.

$$SDF = p(\theta) = \frac{K}{(1 + g^2 - 2g \cos \theta)^{\alpha+1}} \quad (3.7)$$

$$K = \alpha g \frac{(1 - g^2)^{2\alpha}}{\pi[(1 + g)^{2\alpha} - (1 - g^{2\alpha})]} \quad (3.8)$$

TracePro Expert provides a third option for User Defined DLL scattering. See “Using Scatter DLLs” on page 7.63.

Bulk Scatter Property Editor

The bulk scattering property editor defines and modifies scattering profiles stored in the TracePro property database. Select **Define | Edit Properties | Bulk Scatter Properties** to open the editor window.

2. A. N. Yaroslavsky, I. V. Yaroslavsky, T. Goldbach, and H.-J. Schwarzmaier, “Influence of the scattering phase function approximation on the optical properties of blood determined from the integrating sphere measurements”, *Journal of Biomedical Optics* 4(1), 47-53 (January 1999)

TABLE 3.5. Fields used in the Bulk Scattering Information Panel

Catalog	Property catalog names.
Name	Scatter Property Name dropdown box. Select the name from the drop down list or by typing the name into the text box. If the name is found in the database its data is displayed.
Description	The description contains notes about the Bulk Scatter Property.
Type	The Type displays the selected scatter model. The scatter model is defined when a New Property is added to the database. The three models available are: <i>Henye-Greenstein</i> <i>Gegenbauer</i> <i>User DLL</i> Expert

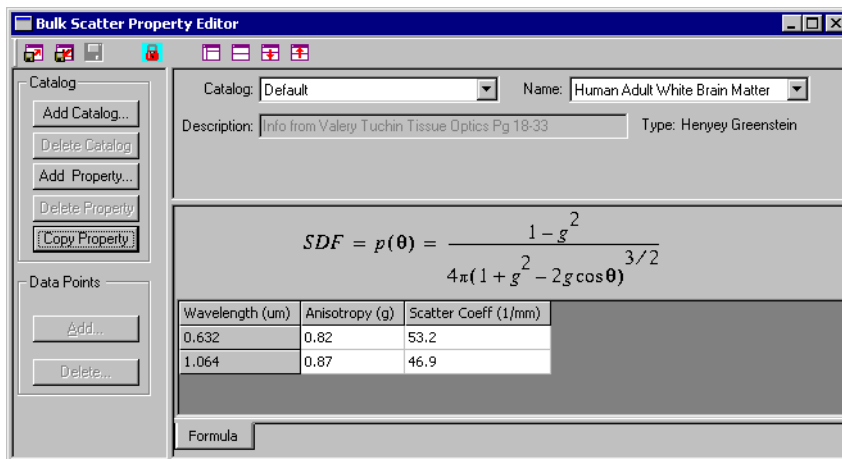
**FIGURE 3.5 - The Bulk Scatter Property Editor****TABLE 3.6. Fields used in the Bulk Scattering Grid Panel**

Anisotropy	Enter the anisotropy factor, g , for the selected wavelength. This measure describes the uneven propagation of light from +1 (forward) to -1 (backward).
Scatter Coefficient	Enter the scattering coefficient, μ_s , for the selected wavelength in units of 1/mm.
Alpha	This is displayed for the Gegenbauer scatter model.
Coeff 0-5	These columns replace the data columns when a DLL scatter model is used. The data entered is passed into the DLL and is used as variable input to alter the DLL calculations.

Expert

Import/Export

The Import/Export format is documented in “Bulk Scatter Property Format” on page 7.105. When the editor is open, the File menu displays Import Property and Export Property menus.

Scatter DLL Expert

TracePro Expert provides functionality to define phase functions for Bulk Scattering through compiled Dynamic Link Libraries (DLLs). Data from TracePro is passed into the DLL during raytrace. The DLL calculates a result, which is passed back to TracePro and used to scatter the ray. The Bulk Scatter Editor is used to select the desired DLL and to add user parameter data to control the calculations performed in the DLL. For more information about “User Defined Bulk Scatter”, see page 7.63.

Fluorescence Properties Expert

Fluorescence is modeled in TracePro through the use of a Fluorescence Property in combination with an object’s material properties. Fluorescence includes relative absorption and relative excitation normalized to the peak molar extinction coefficient, and relative emission. All of the values can be created with variation versus temperature and wavelength. Concentration of the fluorescing material can be set in the model by entering the molar concentration when applying the property to a solid object. A two stage ray trace is used when Fluorescence is enabled in the Raytrace Options. In the first stage of the ray trace, rays are traced in the excitation part of the material spectrum. A by-product of the first stage of the ray trace is that TracePro ray files are generated which contain rays emanating from sites in the fluorescent material. The second stage of the ray trace uses the ray files to trace fluorescent rays.

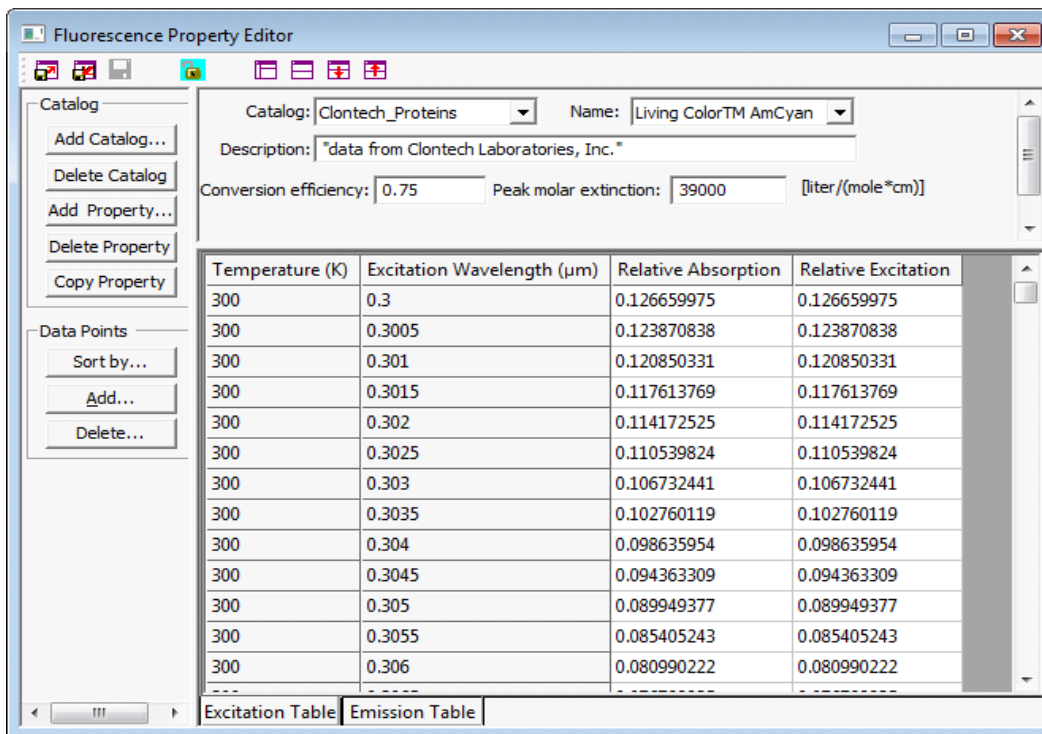

FIGURE 3.6 - Fluorescence Property Editor: Excitation Table

Defining Fluorescence Properties

Clicking on the Add Property button in the Catalog section of the Fluorescence Editor allows you to enter the data shown in the top tab of Figure 3.6:

- Descriptive text (optional)
- Conversion Efficiency
- Peak molar extinction

At this point, you can switch between entering excitation data (Figure 3.6) and emission data (Figure 3.7) by clicking on the appropriate tabs in the lower tab of the Fluorescence Property Editor.

Data to be entered in the Excitation Table:

- Temperature and Excitation Wavelength data - by clicking on the Add button in the Data Points section
- Relative Absorption during the excitation stage
- Relative Excitation during the excitation stage

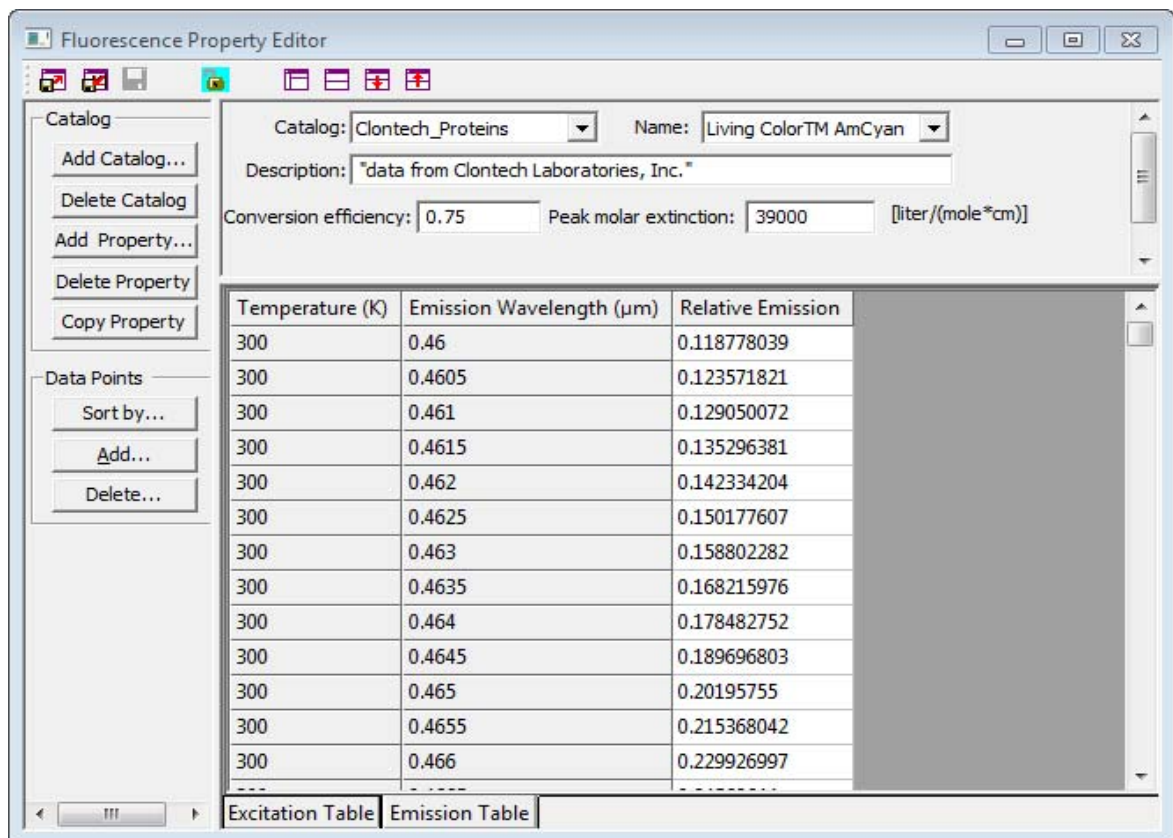

FIGURE 3.7 - Fluorescence Property Editor: Emission Table

Data to be entered in the Emission Table:

- Temperature and Excitation Wavelength data - by clicking on the Add button in the Data Points section
- Relative Emission during the emission stage

The relative absorption, relative excitation, and relative emission values are normalized.

Using the Fluorescence Property Generator

The Fluorescence Property Generator allows you to create a Fluorescence Property from published data for Absorption, Excitation, and Emission spectra. The Fluorescence Property Generator has its own help system. To open the Fluorescence Generator, select **Define | Generate Property Data | Fluorescence Property**.

Fluorescence Calculations

It is customary, in measuring fluorescence spectra, to express the peak molar extinction in base 10 rather than base e. The base 10 absorption coefficient is then

$$\mu_a^{10}(\lambda) = ab(\lambda)K_{peak}C_{molar}$$

where K_{peak} is the peak molar extinction corresponding to the value of 1 in the relative absorption $ab(\lambda)$, and C_{molar} is the molar concentration in the particular sample. The transmittance through a sample of thickness t is then

$$\tau = 10^{-\mu_a^{10}t}$$

The absorption coefficient used in a non-fluorescent material property in TracePro is related to the base 10 absorption coefficient by

$$\mu_a = \mu_a^{10} \ln 10$$

This is used for Lambert/Beer Law absorption, in which the transmittance through a thickness t is

$$\tau = e^{-\mu_a t}$$

The optics absorption coefficient μ_a is computed internally in TracePro for use by the raytrace. The same rule applies to the relative excitation values.

Note: the absorption coefficients: base 10, μ_a^{10} , or base e, μ_a ; and the thickness, t , must be in the same units for these equations to be valid. For example if the first is in millimeters, the second should be in millimeters. However, note that the peak molar extinction, K_{peak} , is in partial units of inverse centimeters (see the first equation in this section and Figure 3.7. Though TracePro works by default in millimeters, the peak molar extinction is typically provided in partial units of inverse centimeters. You must be consistent in using units of centimeters for these calculations.

Fluorescence Ray Trace

A fluorescence ray trace is done in two stages:

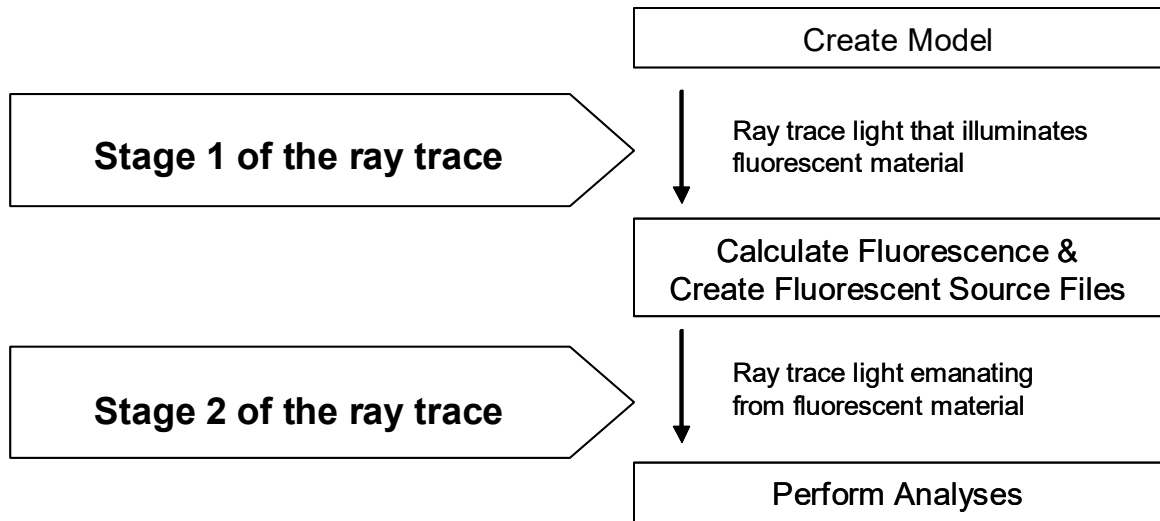

FIGURE 3.8 - Fluorescence ray trace involves two stages

Stage 1: Initial rays are traced in the TracePro model. Any source wavelengths (that also happen to be within the excitation band of fluorescent materials in the model) will be involved in the fluorescence calculation. Note that any wavelengths defined with the selection of Fluorescence emission wavebands will not be valid for the excitation of fluorescent materials in TracePro. The end result of this stage of the ray trace is that ray files containing fluorescent ray data are created.

Stage 2: Fluorescent rays are traced from the previously generated ray files at the mid-points of the Fluorescence emission wavebands defined for each fluorescing object in the Fluorescence tab of the Apply Properties dialog box. Note that for the highest waveband (λ_N to ∞), where the mid-point is ill defined, the fluorescence wavelength is two times the lowest wavelength in the waveband, i.e. $\lambda = 2\lambda_N$.

Figure 3.9 illustrates how property and ray trace data are used in each step of the fluorescence modeling process.

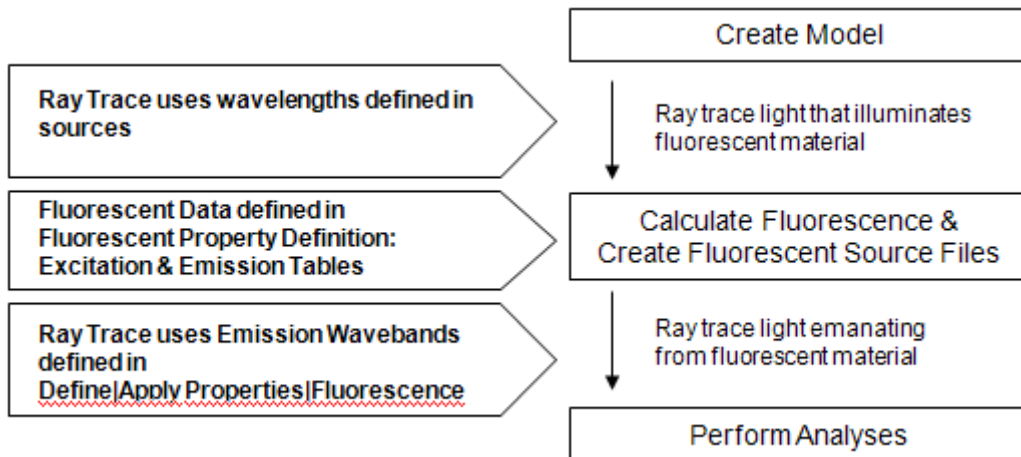

FIGURE 3.9 - Process to perform Fluorescence simulation in TracePro.

Raytrace Options

Fluorescence Option

You can enable the calculation of fluorescent rays via a checkbox in the **Raytrace|Raytrace Options** dialog, Options tab. After the Fluorescence option is checked, there are related options:

There is a drop-down list with two choices:

Immediately trace emission wavelengths - At the conclusion of the excitation ray-trace, the emission ray-trace will automatically begin, so that emission rays are “mixed in” with excitation rays. All irradiance map features, candela plots, flux report, etc. will report the fluorescence emission ray results along with the excitation ray results.

Generate emission source only - At the conclusion of the excitation ray-trace, the emission ray files are generated, but the emission rays will not be traced. You can trace them later at your discretion, by:

- a. inserting the emission ray file(s) into the model (or any model you choose)
- b. disabling any other sources in the Source Tree or Source/Wavelength Selector (or modifying any surface sources in the model to have zero rays, or simply removing the source property altogether)
- c. unchecking the Fluorescence option in the Raytrace Options dialog box
- d. initiating a raytrace.

Insert file source - During the fluorescence raytrace, TracePro will generate ray launch positions and angles to simulate fluorescence emission. These generated rays are stored in ray files to be used during the emission part of the raytrace. This option is used to automatically include the generated ray files into the model.

Surface Source Properties

Surface Source Properties describe the emission of surface sources versus temperature, wavelength, and angle. To create a surface source property, you select the Spectral Type and Angular Type of the property.

Spectral Types

Rectangular

Gaussian

Solar

Table

Angular Types

Lambertian

Uniform

Gaussian

Solar

Table

Any Spectral Type can be combined with any Angular Type. The data required to fully specify the property will vary depending on the choices you make for the Types.

Surface Source Property Editor

In TracePro, surface source properties are identified by a name and stored in a database.

The Surface Source Property editor lets you edit all the surface source properties that exist in the surface source property database or create new surface source properties.

To open the surface source editor, select **Define | Edit Property Data**, then select **Surface Source Properties**. Instead of opening as a dialog box, the editor opens as a window. You can return to the model window by selecting the model at the bottom of the Window menu.

Note: The TracePro main menu bar displays a different set of options when you are in the editor window. Once you are in the Surface Source Property Editor window, you can return to the model window by selecting the model item from the Window menu, or simply clicking on the title bar of the model window.

The Surface Source Property Editor has several parts:

- Catalog, Name, and Description
- Spectral Type and Angular Type
- Emission
- Emissivity spreadsheet

The Emission value specifies how much total flux or irradiance/illuminance the source will emit, in whatever units are selected. The Emissivity values in the spreadsheet serve as weighting factors only and are not absolute emissivities.

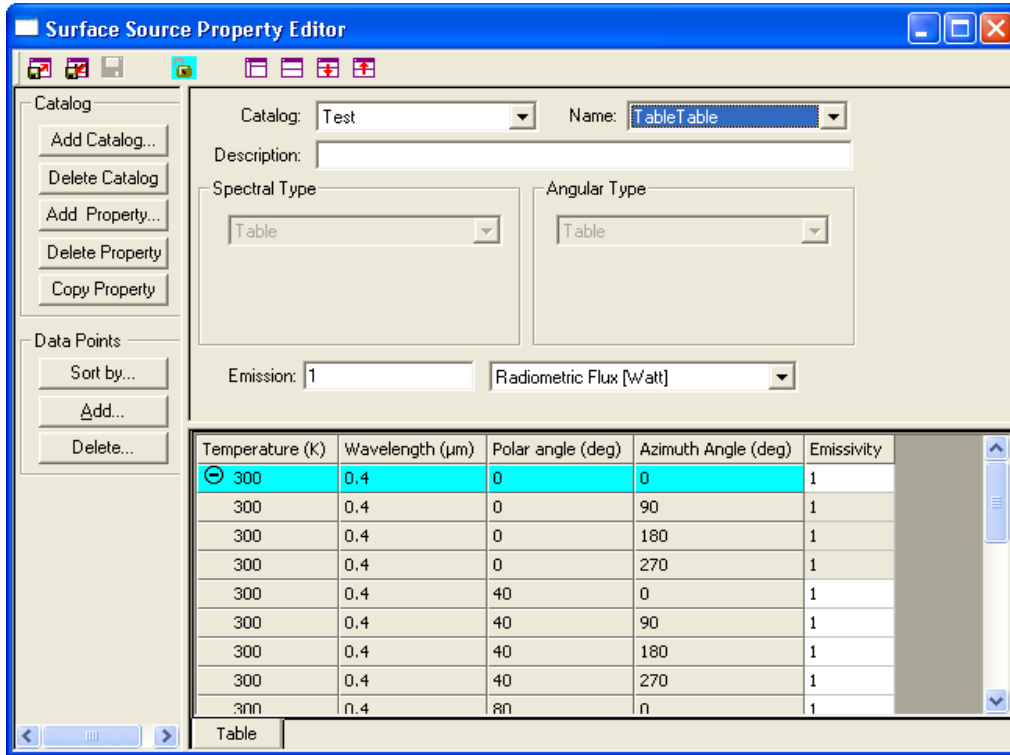

FIGURE 3.10 - The Surface Source Property Editor

TABLE 3.7. Fields in the Surface Source Property Editor- Information and Grid Panels

Catalog	Property catalog names.
Name	Name dropdown box. Select the name from the drop down list or by typing the name into the text box. If the name is found in the database its data is displayed.
Description	The description contains notes about the Surface Source Property.
Spectral Type	The Spectral Type displays the choice made when Adding the property. For types other than Table, additional data fields are available to specify the spectrum.
Angular Type	The Angular Type displays the choice made when Adding the property. For types other than Table, additional data fields are available to specify the angular shape.
Emission	The Emission specifies how much total flux or irradiance/illuminance will be emitted by the source. The choices for units of the source are Radiometric Flux (Watt), Photometric Flux (lumen), Radiometric Irradiance (W/m ²) or Photometric Illuminance (lux).

Create a New Surface Source Property

The steps listed below show the method to create a new property with the Surface Source Property editor.

1. Select **Define | Edit Property Data | Surface Source Properties** to open the Surface Source Property Editor window. Select the Catalog to which you would like to add the property, or click **Add Catalog** to add a new one.
2. Click *Add Property*.
3. Enter a name for the new property, and select the Spectral Type and Angular Type, then click OK.
4. Edit the data in the top pane and the spreadsheet by selecting a value and typing in a changed value. For a Table Spectral or Table Angular type property, add new wavelengths and angles using the **Add...** button in the Data Points box.
5. Select Save from the file menu, or close the Surface Source Property editor and answer Yes to the question “property has changed, save data?”

Edit an Existing Surface Source Property

The steps listed below show the method to edit an existing property in the Surface Source Property editor.

1. Select **Define | Edit Property Data | Surface Source Properties** to open the Surface Source Property Editor window.
2. Select the catalog and name of the property you wish to edit, and select **Unlock**. You cannot make changes without unlocking the property for editing. Properties supplied with TracePro are Read Only and cannot be unlocked or edited.
3. Make your changes and then select Save from the file menu, or close the Surface Source Property editor and answer Yes to the question “Property has changed, save data?”
4. Check the edited property. The updated property is now available in the Surface Source Property database for future use.

Export a Surface Source Property

The steps listed below show the method to export an existing property within Surface Source Properties.

1. Select **Define | Edit Property Data | Surface Source Properties** to open the Surface Source Property Editor window.
2. Choose a surface source property catalog and name from the drop-down lists.
3. Select **File | Export Property** to create a text file that contains the information that defines the selected surface source property. The dialog box prompts you to enter the name and location of the file. For more information about “Gradient Index Property Format”, see page 7.99.

Import a Surface Source Property

The steps listed below show the method to import an existing property within Surface Source Properties.

1. Select **Define | Edit Property Data | Surface Source Properties** to open the Surface Source Property Editor window.

2. Select **File | Import Property** to import a text file (in the proper format) with the definition of a surface source property. The dialog box prompts you to enter the name and location of the file to import.

Using The Surface Source Property Generator

The Surface Source Property Generator allows you to create a Surface Source Property from published data for source emission versus direction and wavelength. The Surface Source Property Generator has its own help system. To open the Surface Source Property Generator, select **Define | Generate Property Data | Surface Source Property**.

Gradient Index Properties Standard Expert

Gradient Index (GRIN) Properties describe materials with indices of refraction that are not constant over the extent of the object. Examples include glass lenses in which the index varies from the edge to the center (e.g., as seen in some eyeglasses) or optical fibers that vary the index across the cross section (e.g., step or gradient optical fiber). Such materials are made via a number of different methods including diffusion, sol-gel, and melding.

The gradient index varies the index of refraction along a parametric profile.

Gradient index properties are identified by name and stored in a database. The Gradient Index Property editor allows you to edit gradient index properties or create new gradient index properties. For more information about “Gradient Index Profile Polynomials”, see page 7.9.

Note: GRADIUM, one of the types in the Type dropdown box of the Gradient Index Property Editor, must be treated differently. GRADIUM is a trademark of a company with a unique treatment of data. Unlike others, the GRADIUM Gradient Index includes material property data and does not require association with a material property. In cases like this one, Do NOT Apply a material property to anything of the type Gradium.

For all other Gradient Index properties, you must apply a material property to supply the base index of refraction. For example, an Axial-Radial profile can be defined with the data shown in Figure 3.11.

Gradient Index Property Editor

In TracePro, a material’s GRIN properties are identified by a name and stored in a database.

The Gradient Index Property editor lets you edit all the GRIN properties that exist in the GRIN property database or create new GRIN properties.

To open the GRIN editor, select **Define | Edit Property Data**, then select **Gradient Index Properties**. Instead of opening as a dialog box, the editor opens as a window. You can return to the model window by selecting the model item from the Window menu.

Note: The menu bar displays a different set of options when you are in the editor window. Once you are in the Gradient Index Property Editor window, you can return to the model window by selecting the model item from the Window menu.

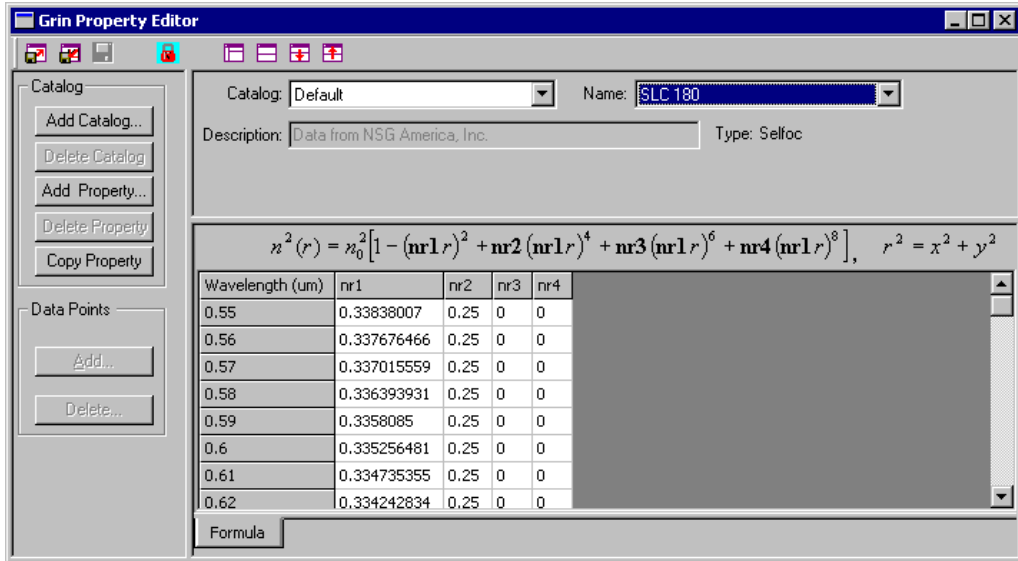

FIGURE 3.11 - The Gradient Index Property Editor

TABLE 3.8. Fields in the Gradient Index Property Editor- Information and Grid Panels

Catalog	Property catalog names.
Name	Gradient Property Name dropdown box. Select the name from the drop down list or by typing the name into the text box. If the name is found in the database its data is displayed.
Description	The description contains notes about the Gradient Property.
Type	The Type describes the Gradient Index Profile selected when the property was defined. See “Gradient Index Profile Polynomials” on page 7.9.
Coefficients	Each Gradient type has an associated set of coefficients corresponding to the Profile Polynomial.

Create a New Gradient Index Property

The steps listed below show the method to create a new property within Gradient Index Properties

1. Select **Define|Edit Property Data|Gradient Index Properties** to open the Gradient Index Property Editor window.
2. Select **Add Property**.
3. Enter a name for the new property, enter a type or select one from the dropdown box, and enter a value for the initial wavelength.
4. Edit the coefficients in the spreadsheets by selecting a value and typing in a changed value.
5. Select **Save** from the file menu, or close the Gradient Index Property editor and answer yes to the question “property has changed, save data?”

Edit an Existing Gradient Index Property

The steps listed below show the method to edit an existing property within Gradient Index Properties.

1. Select **Define|Edit Property Data|Gradient Index Properties** to open the Gradient Index Property Editor window.
2. Select **Unlock**. You cannot make changes without unlocking the property for editing. Properties supplied with TracePro are Read Only and cannot be edited.
3. Select **save** from the file menu, or close the Gradient Index Property editor and answer yes to the question “property has changed, save data?”
4. Check the edited property. The updated property is now available in the Gradient Index Property database for future use.

Export a Gradient Index Property

The steps listed below show the method to export an existing property within Gradient Index Properties.

1. Select **Define|Edit Property Data|Gradient Index Properties** to open the Gradient Index Property Editor window.
2. Choose a gradient index property from the drop-down list.
3. Select **File|Export Property** to create a text file that contains the information that defines the selected gradient index property. The dialog box prompts you to enter the name and location of the file. For more information about “Gradient Index Property Format”, see page 7.99.

Import a Gradient Index Property

The steps listed below show the method to import an existing property within Gradient Index Properties.

1. Select **Define|Edit Property Data|Gradient Index Properties** to open the Gradient Index Property Editor window.
2. Select **File|Import Property** to import a text file (in the proper format) with the definition of a gradient index property. The dialog box prompts you to enter the name and location of the file to import.

Surface Properties

Surface properties define the absorptance, BRDF, BTDF, specular reflectance and transmittance at a surface. In TracePro, surface properties are identified by name and catalog, and are stored in a database.

For detailed descriptions of the components of surface properties such as BRDF and BTDF. For more information about “BSDF”, see page 7.15.

Using the Surface Property Database

A database filled with predefined surface properties exists as a resource in TracePro. You can add your own surface properties using the Surface Property editor. The editor is a separate window. Once you are in the Surface Property window, you can return to the model window by selecting it from the Window menu.

To edit the records in the Surface Property Database, select **Define | Edit Property Data | Surface Properties**.

- The Surface Property Editor lets you modify the data type, description, and data entries of existing user-defined properties.
- The editor is a spreadsheet-style window that displays a row of data for each incident angle, wavelength and temperature.
- Data can be entered for multiple wavelengths, temperatures, and angles of incidence. TracePro performs a linear interpolation between wavelengths, temperatures, and angles during a raytrace for tabular data.
- The name and catalog of the surface property is applied to model data and provides a reference for looking up the data from the TracePro property database.
- Surface properties can be entered using several types of data. See Table 3.10, “Surface Property Types,” on page 3.26.
- Scattering, or BSDF data, may be entered for surfaces based on any of several scattering models. Scattering for transmission (BTDF) and reflection (BRDF) is entered in the data table for each temperature, wavelength, and angle of the surface property. For more information about “BSDF”, see page 7.15.

Using the Surface Property Editor

Select **Define | Edit Properties | Surface Properties** to open the editor window.

The surface property editor has several entries as described in the sections that follow. Notably, under a single name, you can enter properties for multiple temperatures, wavelengths and angles of incidence.

TABLE 3.9. Fields used in the Surface Property Information Panel

Catalog	Name of property catalog selected from dropdown list.
Name	Select a name from the <i>Name</i> : dropdown list or enter the name of a surface property not included in the data. The name of the surface property serves as its reference in all parts of TracePro. If the name you type matches the name of a coating in the database, its data displays in the spreadsheet part of the Surface Property Editor. When you add a new surface property, you are first prompted for its name, because this is the minimum amount of data needed to define a surface property.
Description	The description is optional. It provides a place to describe a surface property more fully than you can using the name.
Type	Choose from the following dropdown list: Fresnel, Table, Stack, Grating, Anisotropic or Coating DLL. As you define a new property, the type 'Table' is displayed by default and the field 'Solve For' is activated to await a selection of values to calculate. See Table 3.10, "Surface Property Types," on page 3.26.
Scatter	This displays the scatter model used by the property. The scatter model is selected when the property is created by a selection in the Add Property dialog.
Retroreflec-tion	Place a check in this check box to give a surface the property of retroreflec-tance instead of transmittance. When you define a new surface property, the Retroreflector box is unchecked by default. To create a surface property that models a surface as being retroreflecting, check the Retroreflector box [Note: Retroreflector is not available with Grating type]. If you place a check in the Retroreflector check box, the columns for Specular Transmittance and BTDF change to Specular Retroreflectance and BRDF (Bidirectional Retroreflec-tance Distribution Function). That lets you enter the specular retroreflection coefficient as well as scattering that is referenced to the retroreflection direc-tion. No transmission is allowed for a retroreflecting surface. Beware that the BRDF is really a contributor to the total BRDF of the surface property. The real total BRDF of the surface is equal to the sum of the TracePro BRDF and BRDF.
Polarization Standard Expert	Place a check mark in this check box to display polarization terms. This adds columns for S and P polarization, and Phase data for the specular components of the property.
Stack Standard Expert	The Stack drop down list provides a selection of available Thin Film Stack defini-tions. This is shown for Stack type surface properties. You need to define a stack using the Stack Editor before it can be used with a surface property. See "Thin Film Stacks" on page 3.43.
Spacing Standard Expert	For Grating surface properties, a Spacing entry is displayed to provide the grating spacing of the property.
Side 1/2 Mate-rial Property Standard Expert	Used for Direction-sensitive properties. This defines the Material to be applied to each side of the property. The Property values are entered in a Side 1 and Side 2 panel to define the behavior of the surface depending on which side is struck by the ray.
DLL Name Expert	For Coating DLL surface types, a DLL Name and Browse button is displayed to provide the path and file name of the used defined coating DLL. See "User Defined Surface Properties" on page 7.28.

The following table describes the types of surface properties supported by TracePro.

TABLE 3.10. Surface Property Types

<p>Fresnel</p>	<p>The Fresnel type assumes that no coating is applied to the surface and that TracePro uses the material property data of the object(s) on either side of the surface to calculate Fresnel reflection and transmission. Scatter data may be included. Use the Fresnel type for an uncoated, polished optical surface with scattering due to microroughness, i.e. scattering that obeys shift-invariance. This Surface Property type is not intended, and does not work correctly, for diffuse surfaces. See “Calculation of Fresnel coefficients during raytrace” on page 7.26 for further discussion on this topic.</p>
<p>Table</p>	<p>The Table type stores data in tabular form for various incident angles, wavelengths and temperatures. The reflectance and transmittance may be entered with or without polarization terms. Scatter terms may be included and the data can use the Solve For functions. Typically tabular data comes from measurements.</p>
<p>Stack</p> <p>Standard</p> <p>Expert</p>	<p>The Stack type calculates the specular data using a thin film stack and the material property data of the objects on either side of the surface. Polarization effects are included in the stack calculation. Scatter data may be added in tabular form in the Grid Panel. See “Thin Film Stacks” on page 3.43.</p>
<p>Grating</p> <p>Standard</p> <p>Expert</p>	<p>The Grating type is like the Table type, except that the specular reflection and transmission entries are calculated from reflected and transmitted grating efficiencies, entered in the Grid Panel of the editor. Rays are split for each of the defined grating orders. Scatter data may be included and the data can use the Solve For functions. Grating parameters can also be imported from GSolver¹. Since the Grating type allows for the entry of azimuthal angles, anisotropic gratings can be defined.</p>
<p>Direction Sensitive</p> <p>Standard</p> <p>Expert</p>	<p>This type allows surface properties that will have different behavior depending on which side is struck by the ray. Each side of the property has a Material Property assigned and includes an input tab to define the property values for the respective surface side designated as Side 1 and Side 2. See “Direction-Sensitive Properties” on page 3.28. Since the Direction Sensitive type allows for the entry of azimuthal angles, anisotropic surfaces can be defined.</p>
<p>Anisotropic</p> <p>Standard</p> <p>Expert</p>	<p>The Anisotropic type is entered in tabular format and includes one or more azimuthal angles for each incident angle, wavelength and temperature. Scatter data may be included and the data can use the Solve For functions. See “Anisotropic Surface Properties” on page 7.26.</p>
<p>Coating DLL</p> <p>Expert</p>	<p>This type uses a user supplied DLL to calculate the specular components of the property. Scatter data may be included in the Grid Panel. See “User Defined Surface Properties” on page 7.28.</p>

1. GSolver (<http://www.gsolver.com/gsprod.html>) is a diffraction grating design and analysis software program produced by Grating Solver Development Co. GSolver now includes an option to export a TracePro grating type surface property which can then be imported into TracePro. See “Importing a Surface Property” on page 3.30.

TABLE 3.11. Selections for Scatter Model

ABg	A three-parameter mathematical model for rotationally-symmetric BSDF.
Elliptical ABg	An asymmetric, elliptically-interpolated ABg scatter model.
Elliptical Gaussian	A product of two Gaussian functions in orthogonal directions. A circular Gaussian can also be made, by setting the two variance values equal to each other.
Table BSDF	A rotationally-symmetric BSDF model with a table of BSDF values versus $ \beta - \beta_0 $.
Asymmetric Table BSDF	A completely asymmetric BSDF model, the most general that TracePro offers. Enter a table of values versus radial and azimuthal components of $\beta - \beta_0$.
1D ABg	A BSDF model with biaxial symmetry, it is a product of an ABg model in the local x direction and a Gaussian in the local y direction, used for modeling surfaces that scatter light into a narrow slice of the scattering hemisphere.
1D Table	Similar to the 1D ABg model, local-x-direction behavior is determined by a table of BSDF values. The table allows for positive and negative values of $(\beta - \beta_0)_x$ to enable asymmetry along the local x axis.
Use BSDF Properties	Use one or more BSDF properties from the BSDF database instead of explicitly defining the BSDF within the surface property.

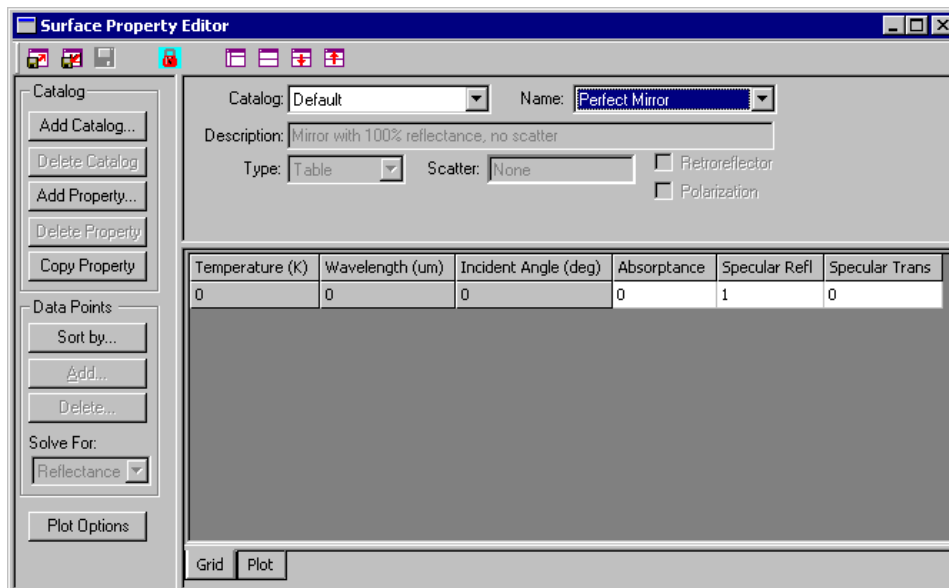

FIGURE 3.12 - The Surface Property Editor

Using Solve for

Solve for: uses values on the editor spreadsheet to find the value specified in the *Solve for:* dropdown list. To be correct, the values must conform to the law of conservation of energy—absorptance, specular reflectance, specular transmittance, integrated BRDF, and integrated BTDF must total 1. TracePro will not allow you to save a property that does not conserve energy.

'Solve For' is available for Table, Anisotropic and Grating type properties only. If the *Type*: field is set to "Table", "Anisotropic" or "Grating", then the *Solve for*: field is active.

With Table and Anisotropic types, select *Solve for*: to derive one of the following values:

- Absorptance
- Specular reflectance
- Specular transmittance
- BRDF
- BTDF (or BRRDF)

With Grating type, select *Solve for*: to derive one of the following values:

- Absorptance
- BRDF
- BTDF

Note that *NONE* is also available on the *Solve for*: dropdown list. If you select *NONE* and type in values that do not compute, you cannot close the editor. It prompts you with a message. If absorptance is set to 0.3 and all other values are zero, a message displays. Even with the solve feature turned off, the editor notes whether or not the numbers' sum is 1.

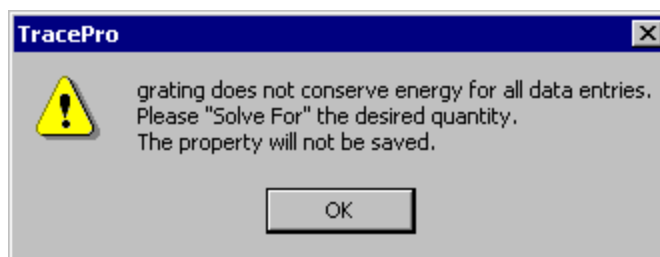

FIGURE 3.13 - Conservation Warning Dialog.

For example, if you are developing a new surface property for a mirror, it is likely that you know the BRDF from measured data, and you also know the absorptance, perhaps from published data or from measurements. To enter the complete surface property, you do the following:

1. Enter *BRDF A*, *B* and *g* according to your measurements.
2. Enter the *Absorptance*.
3. From the *Solve for* drop-down box, select *Reflectance*.

Once you select Reflectance, the specular reflectance entry is updated.

Direction-Sensitive Properties

"Direction-Sensitive" surfaces offer an added level of flexibility to Surface Properties. When defining the property, you must select the medium on Side 1 and Side 2:

NOTE: When a material property of "<None>" is desired, it does not matter which catalog is used. i.e. Schott | <None>, OHARA | <None>, and HOYA | <None> are all equivalent

- When creating a “Direction-Sensitive” surfaces, you supply a Material Property for Side 1 and a Material Property for Side 2 - this is defined to match the grating efficiencies to media on the two sides of the interface.
- When raytracing, TracePro uses this information to determine which set of efficiencies (Side 1 or Side 2) to use when a ray is incident on a surface.
- At the point of surface intersection, TracePro checks to see if the incident medium is one of the two media assigned to the property.
 1. If the incident media does not match either of the material properties defined, TracePro warns you and notifies you that the Side 1 data will be used.
 2. If TracePro finds a match, TracePro will use the side that matches
- TracePro will also check the medium on the on the other side of the intersection (the transmission side).
 1. If the transmission side does not match, TracePro displays a warning in the Message Window
 2. If the transmission side matches, no warning is needed - the model is set-up as intended

For Direction-Sensitive surfaces, the Surface Property editor includes a separate page for entering the efficiencies of each side (see tab for Side 1 and Side 2 at bottom of Surface Property Editor Window).

The Temperatures, Wavelengths, Incident Angles, Azimuth Angles, and Grating Orders are all kept in sync between the two Sides of the property. When any of these parameters are added to the property, they are simultaneously added to both sides

Creating a new surface property

The steps listed below show the method to create a new property within Surface Properties.

1. Select **Define|Edit Property Data|Surface Properties** to open the Surface Property editor window.
2. Choose a catalog from the catalog dropdown list.
3. Click on *Add Property*, enter a name for your new property and values for initial angle and initial wavelength.
4. Edit the other values simply by selecting a value and making changes.
5. Select **File|Save** from inside the Surface Property editor window or close the Surface Property editor and answer yes to the question “property has changed, save data?” Your new property is now available in the Property Database for future use.

Editing an Existing Surface Property

The steps listed below show the method to edit an existing property within Surface Properties.

1. Select **Define|Edit Property Data|Surface Properties** to open the Surface Property editor window.
2. Choose a catalog from the catalog dropdown list.
3. Choose the name of your property from the dropdown name catalog.

4. Press on the Lock icon in the Toolbar to enable editing. You cannot make changes to a property that is Read Only. Pre-defined manufacturer properties cannot be edited unless you export them to text format, change their status to user defined, and re-import them into TracePro. See the Surface Import/Export Format Help topic for most up-to-date information.
5. Select the values you want to change and enter the new data.
6. Select **File|Save** or close the Surface Property editor and answer yes to the question “property has changed, save data?” The edited property is now available in the Surface Property database.

Exporting a Surface Property

The steps listed below show the method to export an existing property within Surface Properties.

1. Select **Define|Edit Property Data|Surface Properties** to open the Surface Property editor window.
2. Choose a catalog from the catalog dropdown list.
3. Choose the name of your property from the dropdown name catalog.
4. Use the **File|Export Property** command to create a text file that contains the information for the selected surface property. The dialog box prompts you to enter the name and location of the text file you will create. You can find out more about the format used by TracePro for these files by referring to the Surface Import/Export Format section in the TracePro help file. The exported file is a tab-delimited text file that can be opened with a spreadsheet program.

Importing a Surface Property

The steps listed below show the method to import a property within Surface Properties.

1. Select **Define|Edit Property Data|Surface Properties** to open the Surface Property editor window.
2. Use the **File|Import Property** command to import a text file (in the proper format) that contains the information for a surface property. The dialog box will prompt you to enter the name and location of the file to import. You can find out more about the format used by TracePro for these files by referring to the Surface Import/Export Format section in the TracePro help file.

Surface Property Plot Tab

The Surface Property Plotter evaluates the optical properties of a surface. Many properties vary due to wavelength, angle or other parameter. The Property Plotter provides visualization of such properties with options to define the display parameters. You can make plots of performance versus wavelength or angle of incidence. The plotter is independent of the TracePro model and can be used to perform “What if” studies to evaluate different combinations of surface properties. In Figure 3.14, you see a plot of an AR coated piece of Schott BK7 glass measured vs. wavelength.

From the Surface Property Editor, click on the Plot tab in the editor. The selected property will be displayed for the current set of plot options.

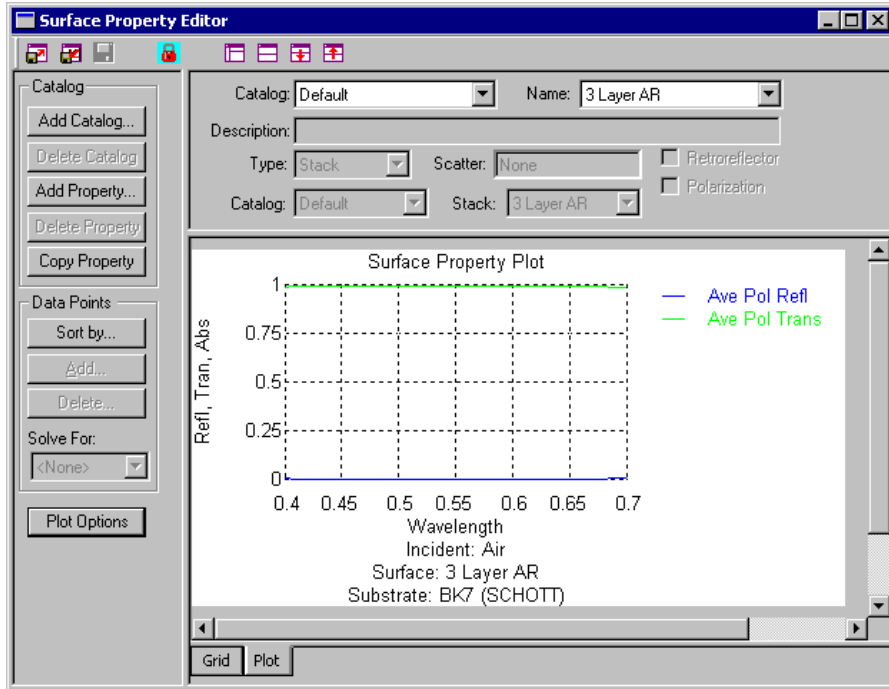

FIGURE 3.14 - Surface Property Editor Window

To modify the display parameters or materials used in the calculation, select the Plot Options button to modify the plot parameters.

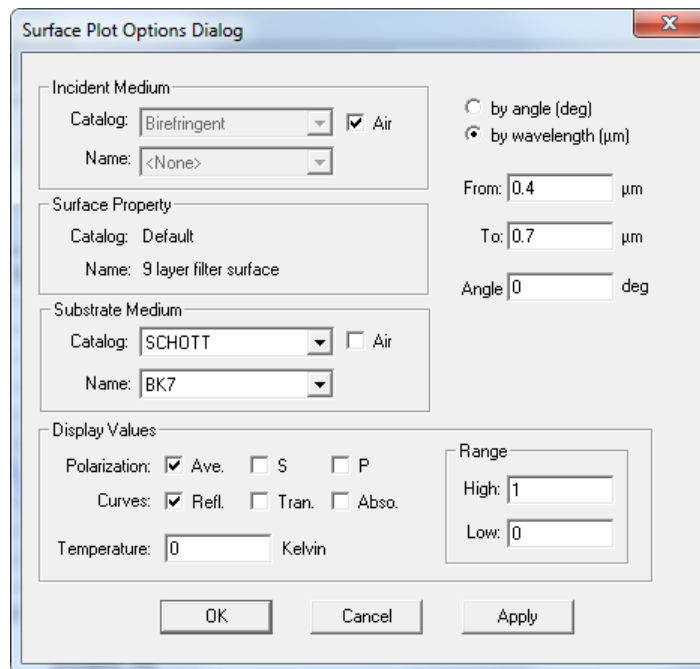

FIGURE 3.15 - Surface Plot Options Dialog

Incident Medium

Select a material that is an interface to one side of the surface property to be plotted. This selection specifies what the light ray travels through before reaching the surface.

Catalog	Select an appropriate catalog of optics materials from the dropdown list. This box is grayed out if the Air check box contains a check mark.
Name	Select an incident medium property name from the dropdown list. This box is grayed out if the Air check box contains a check mark.
Air	Place a check mark in the Air check box if there is no object in the path of the light ray before it reaches the surface property to be plotted.

Substrate Medium

Select a substrate medium material property by selecting a catalog and a name, or select Air to indicate that no object or interface exists on the side of the surface property where light rays exit.

Catalog	Select an appropriate catalog of optics materials from the dropdown list.
Name	Select the name of the substrate medium from the Name dropdown list.
Air	Select Air by placing a check mark in the Air check box indicating that no object or interface exists on the side of the surface property where light rays exit.

by angle (deg)

Enter the angle range in degrees and a wavelength in microns.

from	Enter the beginning of the angle range [any number 0-90].
to	Enter the end of the angle range [any number 0-90]
wave (um)	Enter a wavelength.

by wavelength (um)

Enter the wavelength range and an angle.

from	Enter the start number of the wavelength range.
to	Enter the end number of the wavelength range.
angle	Enter an angle [any number 0-90].

Display Values

Select the curves to plot. Polarization and temperature can modify the curves dependent on the level of data entered for these parameters. Without polarization selection, some curves cannot be plotted.

Polarization	Select by checking one or more check boxes for Ave (Average), S (S-axis), and P (P-Axis).
Curves	Select by checking one or more check boxes for Refl (Reflection), Tran (Transmission), and Abso (Absorption).
Temperature	Type the Temperature in Kelvin into the text entry box.
Range	Enter the minimum and maximum values for the vertical axis of the plot.

Table BSDF Expert

TracePro supports two types of tabular BSDF models: Table BSDF and Asymmetric Table BSDF. To use the Table BSDF model, you enter a table of BSDF values versus the radial component of $|\beta-\beta_0|$. See “Harvey-Shack BSDF” on page 7.16. During the ray-trace, TracePro linearly interpolates between the tabulated values. To use the Asymmetric Table BSDF model, you enter a two-dimensional table of BSDF versus the radial and azimuthal components of $|\beta-\beta_0|$. During the ray-trace, TracePro bilinearly interpolates the two-dimensional table to determine the BSDF. Selection of a Table BSDF model is independent of whether the TracePro Surface Property is anisotropic.

Creating a Table BSDF Property

To create a surface property with Table BSDF:

1. Select **Define | Edit Property Data | Surface Properties** to open the Surface Property editor window.
2. Choose a catalog from the catalog dropdown list.
3. Click on *Add Property*. When the *Enter New Surface Property* dialog box is displayed as shown in Figure 3.16, select *Table BSDF* from the *Scatter Model* list, enter a name for your new property and values for initial angle and initial wavelength, then click OK.
4. Edit the other values simply by selecting a value and making changes.
5. Select **File | Save** from inside the Surface Property editor window or close the Surface Property editor and answer yes to the question “property has changed, save data?” Your new property is now available in the Property Database for future use.

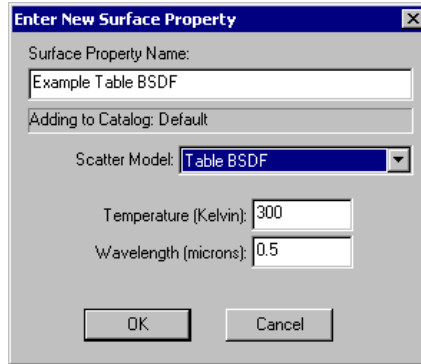

FIGURE 3.16 - Selecting Table BSDF from the Scatter Model list in the Enter New Surface Property dialog box.

The new Table BSDF surface property will be displayed in a spreadsheet as shown in Figure 3.17.

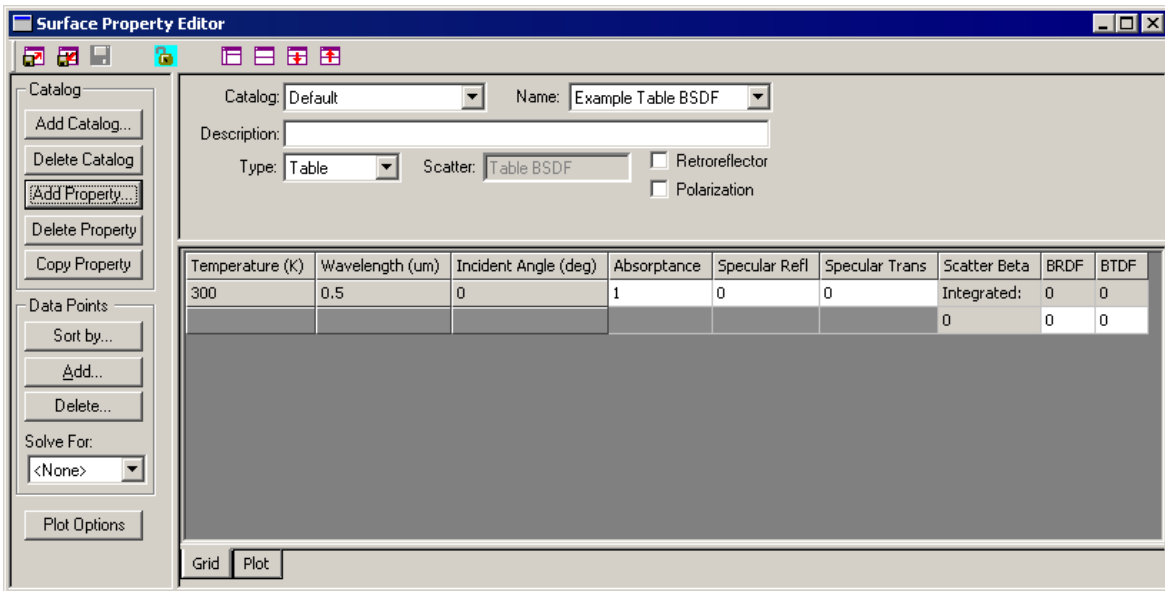

FIGURE 3.17 - Surface Property editor created with Table BSDF type.

On the right side of the spreadsheet are columns for Scatter Beta, BRDF, and BTDF. The Scatter Beta column provides values of $|\beta-\beta_0|$ for tabulating both the BRDF and the BTDF. These values are independent of the Incident Angle values for the surface property. The first row for a provided incident angle (shown in the 3rd Column) provides the integrated BRDF and BTDF for this angle. The integrated BRDF and BTDF is the total scattered flux into a hemisphere from the surface normal. The rows following the integrated amount represent $|\beta-\beta_0|$ values and the respective BRDF and BTDF at these angular offsets from the specular direction. See page 7.15 for more details about this process.

To add more $|\beta-\beta_0|$ rows, click **Add** to open the *Surface Property – Add Data Dialog* dialog box as shown in Figure 3.18. Select Scatter Beta, enter the $|\beta-\beta_0|$ value in the dialog box (the value 0.01 is shown) and click OK.



FIGURE 3.18 - Adding a new value of $|\beta-\beta_0|$ to the BSDF table.

You can add as many Scatter Beta values as you wish. You may find it easier to create a template for the Table BSDF property and export it to a text file, fill in the BSDF values, and import the property. This is usually easier than typing in all the BSDF values in the Surface Property spreadsheet. This requires nine steps:

1. Create a Table BSDF surface property with a value of $|\beta-\beta_0|$. Add some of the data that will be needed by the property. This data will act as a template in the following steps.
2. Save the property into the database using **File|Save**.
3. Export the property to a text file using **File|Export**. The result is a tab-delimited text file, which works best with spreadsheet programs such as Microsoft Excel.
4. Import the file into a spreadsheet program like Excel. (Figure 3.19 shows our example property imported into Excel. There are more columns to the right in the property, but we do not need to view them for our example.)
5. Fill in new values for Scatter Beta, BRDF, and BTDF per your available data. Figure 3.20 shows our example with BRDF data only, suitable for a mirror.
6. Save the text file and close Excel.
7. Import the text file in the Surface Property Editor using **File|Import**, as shown in Figure 3.21.
8. Enter values for the other property table coefficients, e.g. absorptance, specular reflectance and specular transmittance.
9. Use the Solve for feature, if necessary, to make the property conserve energy. The completed example surface property is shown in Figure 3.22.

TracePro Surface Property Data									
1	TracePro Surface Property Data								
2	File Name C:\Program Files\Lambda Research Corporation\TracePro33X\TracePro.mdb								
3	TracePro Release: 3 3 0								
4	Database Version: 3 3 0								
5	Data generated at 18:23:05 December 07, 2004								
6									
7	Name	Example Table BSDF							
8	Catalog	Default							
9	Description								
10	Coating	1							
11	Scatter	4							
12	Interaction	0							
13	Polarization	0							
14	User Data	1							
15	Solve	NONE							
16									
17	Temperature	Wavelength	IncAngle	AziAngle	Abso_S	Abso_P	Refl_S	Refl_P	Tran
18	300	0.5	0	0	1	1	0	0	
19	Table_BSDF_Data								
20	Temperature	Wavelength	IncAngle	AziAngle	ScatterBet	ScatterAzi	BRDF	BTDF	
21	300	0.5	0	0	0	0	0	0	
22	300	0.5	0	0	0.01	0	0	0	
23									
24									
25									
26									

FIGURE 3.19 - Table type surface property with Table BSDF model after importing into Excel.

	A	B	C	D	E	F	G	H	
1	TracePro Surface Property Data								
2	File Name	C:\Program Files\Lambda Research Corporation\TracePro33X\TracePro.mdb							
3	TracePro Release:	3 3 0							
4	Database Version:	3 3 0							
5	Data generated at	18:23:05 December 07, 2004							
6									
7	Name	Example Table BSDF							
8	Catalog	Default							
9	Description								
10	Coating	1							
11	Scatter	4							
12	Interaction	0							
13	Polarizatio	0							
14	User Data	1							
15	Solve	NONE							
16									
17	Temperatu	Wavelengt	IncAngle	AziAngle	Abso_S	Abso_P	Refl_S	Refl_P	Tran
18	300	0.5	0	0	1	1	0	0	
19	Table_BSDF_Data								
20	Temperatu	Wavelengt	IncAngle	AziAngle	ScatterBet	ScatterAzi	BRDF	BTDF	
21	300	0.5	0	0	0	0	12	0	
22	300	0.5	0	0	0.01	0	10	0	
23	300	0.5	0	0	0.02	0	2.5	0	
24	300	0.5	0	0	0.05	0	0.4	0	
25	300	0.5	0	0	0.1	0	0.1	0	
26	300	0.5	0	0	0.2	0	0.025	0	
27	300	0.5	0	0	0.5	0	0.004	0	
28	300	0.5	0	0	1	0	0.001	0	
29	300	0.5	0	0	2	0	0.00025	0	
30									

FIGURE 3.20 - Surface property after filling in example values for $|\beta-\beta_0|$ and BRDF.

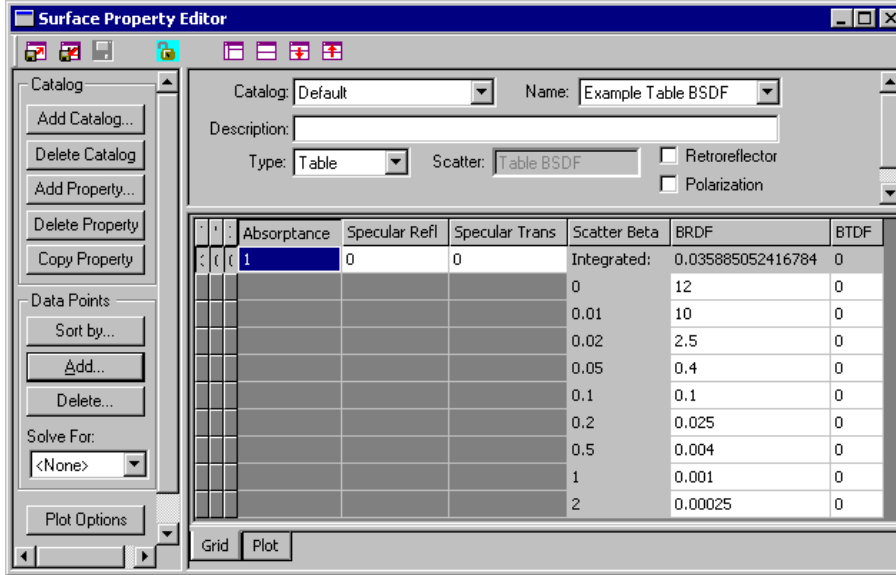

FIGURE 3.21 - Example table BSDL after importing back into the Surface Property Editor. TracePro has computed the Integrated BRDF.

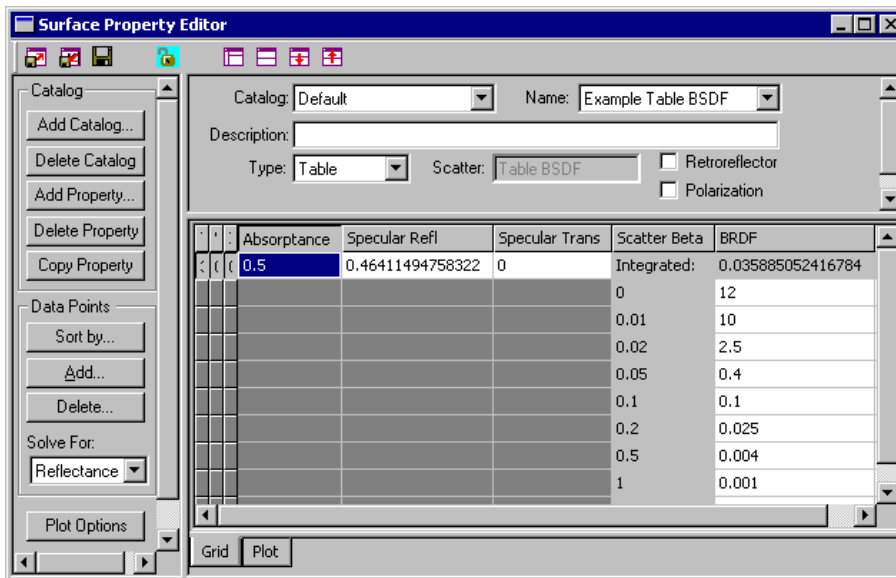

FIGURE 3.22 - Table BSDL surface property after entering 0.05 for absorptance and solving for Reflectance. The property is complete and ready for use.

You can use the Solve For feature to compute the BRDF and BTDF with a Table BSDL model, but you must enter factors into each of the BRDF or BTDF cells. These factors represent the ratio of the actual BRDF or BTDF values in the cells upon computation due to the Solve For. This process will ensure energy conservation while allowing you to ignore the complexity of doing the rigorous calculations.

Creating an Asymmetric Table BSDF Property

To create a surface property with Asymmetric Table BSDF:

1. Select **Define|Edit Property Data|Surface Properties** to open the Surface Property editor window.
2. Choose a catalog from the catalog dropdown list.
3. Click on *Add Property*. When the *Enter New Surface Property* dialog box is displayed as shown in Figure 3.23, select *Asymmetric Table BSDF* from the *Scatter Model* list, enter a name for your new property and values for initial angle and initial wavelength, then click OK.
4. Edit the other values simply by selecting a value and making changes.
5. Select **File|Save** from inside the Surface Property editor window or close the Surface Property editor and answer yes to the question “property has changed, save data?” Your new property is now available in the Property Database for future use.

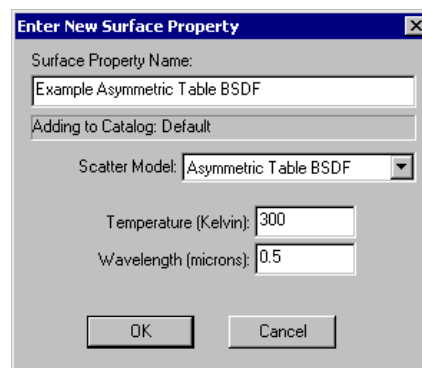

FIGURE 3.23 - Selecting Asymmetric Table BSDF from the Scatter Model list in the Enter New Surface Property dialog box.

The new surface property will be displayed in a spreadsheet as shown in Figure 3.24. For this example we have chosen a Table type surface property, but you can choose any other property type that you wish.

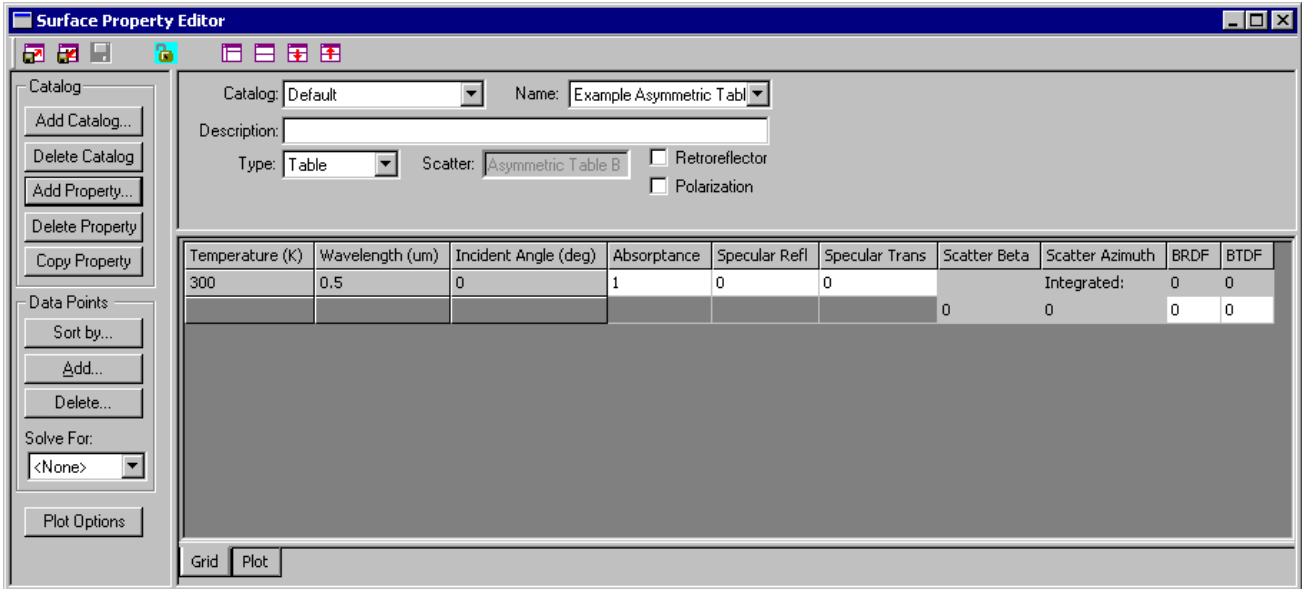

FIGURE 3.24 - Surface Property editor created with Table Asymmetric BSDF type.

The first row for a provided incident angle (shown in the 3rd Column) provides the integrated BRDF and BTDF for this angle. The integrated BRDF and BTDF is the total scattered flux into a hemisphere from the surface normal. The rows following the integrated amount represent $|\beta-\beta_0|$ values, azimuth angles and the respective BRDF and BTDF at these angular offsets from the specular direction. See page page 7.15 for more details about this process.

To add more $|\beta-\beta_0|$ or scatter azimuth values, click **Add** to open the *Surface Property – Add Data Dialog* dialog box as shown in Figure 3.25. Select Scatter Beta or Scatter Azimuth, enter the value in the dialog box (the value $|\beta-\beta_0| = 0.01$ is shown) and click OK. Like all data in the TracePro database, the data is laid out in a rectangular array. That is each time you enter a new value of Scatter Beta, TracePro fills in all the values of Scatter Azimuth for the new beta value. Conversely, when you enter a new azimuth, TracePro fills in all the beta values. Therefore if you enter M values of beta and N values of azimuth, there will be MxN rows in the table.

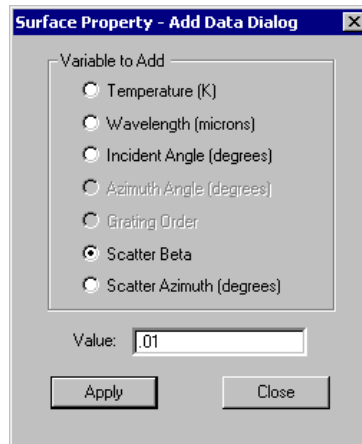

FIGURE 3.25 - Adding a new value of $|\beta-\beta_0|$ to the BSDF table.

You can add as many Scatter Beta and Scatter Azimuth values as you wish. You may find it easier to create a template for the Asymmetric Table BSDF property and export it to a text file, fill in the BSDF values, and import the property. This is usually easier than typing in all the BSDF values in the Surface Property spreadsheet. For instructions on doing this, see the example in the Table BSDF section above.

Using an Asymmetric Table BSDF property

To use a Surface Property with Asymmetric Table BSDF, simply apply the property to a surface in the usual way. You will have to specify the orientation vectors the same way as for an Elliptical ABg BSDF Surface Property or an Elliptical Gaussian BSDF Surface Property. For more information about “Surface Properties”, see page 4.10.

Using The BSDF Converter

The BSDF Converter enables you to import measured BSDF data from a variety of file formats and create a surface property based on that data.

The BSDF Converter can import any of the following file formats:

- FRED file (*.txt)
- Radiant Imaging IS-SA file (*.bsdf)
- Radiant Imaging Imaging-Sphere file (*.txt)
- Scattermaster file (*.csv)
- ALANOD file (*.txt, *.ind)
- SPEOS file (*.bsdf)
- opsira file (*.csv)
- Ophir binary (*.prw)
- Oxytech File (*.csv)

- PIDC File (*.xls)
- LTW File (*.ltw)
- TracePro Candela File (*.txt)
- CASI and ASTM File

The converter can export the data as either an ABg Model or an Asymmetric Table BSDF type TracePro Surface Property. To open the BSDF Converter, select **Define|Generate Property Data|BSDF**. The BSDF Converter has its own help system.

Using BSDF Properties

When creating a surface property, you can elect to use one or more BSDF Properties from the BSDF database instead of explicitly defining them in the surface property.

Creating a Surface Property using BSDF Properties

To create a surface property using BSDF Properties:

1. Select **Define|Edit Property Data|Surface Properties** to open the Surface Property editor window.
2. Choose a catalog from the catalog dropdown list.
3. Click on *Add Property*. When the *Enter New Surface Property* dialog box is displayed as shown in Figure 3.16, select *Use BSDF Properties* from the *Scatter Model* list, enter a name for your new property and values for initial angle and initial wavelength, then click OK.
4. Edit the other values simply by selecting a value and making changes.
5. Select the BSDF Property tab and choose the Catalog and Name in the grid of the BSDF Property you would like to use. To add more properties, click the *Add...* button.
6. Select **File|Save** from inside the Surface Property editor window or close the Surface Property editor and answer yes to the question "property has changed, save data?" Your new property is now available in the Property Database for future use.

Wire Grid Polarizers Expert

Lambda Research has written dynamic-linked libraries (DLLs) to incorporate data obtained from MOXTEK, Inc. for their current line of wire grid polarizers. For further detailed information on these polarizers, please contact MOXTEK directly at www.moxtek.com.

The TracePro surface property information is contained in the following files:

- The Moxtek properties are included in the default property database shipped with TracePro.
- Surface Properties\Moxtek\PBFxx.dll (Data DLLs, one for each type of wire grid polarizer). You must download these from www.lambdares.com, in the TracePro Technical Support section, on the Properties page. After you have downloaded the zip file, you can keep the DLLs in any convenient folder.
- Surface Properties\Moxtek_SurfacePropertyCatalog.txt on www.lambdares.com contains a concatenated file of the surface properties associated with the Data DLLs. You should not need to use this file except for upgrading very old TracePro database installations.

The surface properties refer to a <TBD> location for their respective DLL. To use these surface properties, you must first edit the Surface Property, specifically the location of DLL file. Open and unlock the property in the Surface Property Editor, then edit the DLL name. You can browse to the location or simply type it in the text box.

Applying Wire-Grid Surface Properties

After putting the wire-grid surface properties into your database, apply these properties in the standard way in TracePro – via the *Apply Properties* dialog box's Surface tab.

When applying these properties you will also be prompted for location and orientation information. This is accomplished by supplying the x, y, and z components of the *Origin*, *Normal Direction*, and *Up Direction*.

The *Origin* locates the property in 3D space.

The *Normal Direction* can be considered the local z direction and designates the propagation direction through the polarizer.

Finally, the *Up Direction* can be considered the local y direction and designates the direction of the wires of the wire-grid polarizer.

Once this location and orientation information is applied to the surface, subsequent moving or rotating of the TracePro object will automatically update this information to simulate the actual re-orientation of such a component as if on an optical bench.

Thin Film Stacks Standard Expert

TracePro uses Thin Films to calculate the specular properties of dielectric multi-layer stacks. The Thin Film calculations in TracePro assume a coherent plane wave of light and follow the theory from Born & Wolf section 1.6.3 (7th expanded edition, Cambridge, 1999). Grazing incidence is not a "special case," so the calculations are valid for all angles of incidence, provided the "coherence assumption" holds.

Thin Films work in conjunction with the Material Properties for the index and absorption coefficients, the Stack Editor to define the layers of the film and with the Surface Properties as a component of a Surface Property. You can not directly apply a Thin Film to a surface in TracePro rather you apply a Surface Property that contains a Thin Film. The Stack Editor is shown in Figure 3.26.

If the materials are entered with wavelength and temperature dependence, the stack and subsequent surface property is fully dispersive.

Any number of layers may be used to define a Thin Film Stack. The thickness should be greater than zero but if a zero thickness is entered the layer is effectively removed from the stack during evaluation.

Using the Stack Editor

The Stack Editor provides a means to add or change the various layers to a stack. Select **Define | Edit Properties | Thin Film stacks** to open the Stack Editor window.

Stacks are entered like a table with the first layer, the top row, in contact with the incident medium and the last layer, the bottom row, in contact with the substrate medium. The substrate medium corresponds to the Object that the Surface Property is applied to.

TracePro stacks are constructed using the Material Properties database. Any material defined in the various material catalogs can be inserted as a layer. Each stack layer also requires a thickness (in microns).

TABLE 3.12. Fields in the Stack Editor Information and Grid Panels

Catalog	Name of property catalog selected from dropdown list.
Name	Property name selection box. Select a name in the <i>Name</i> dropdown list box or by typing the name into the <i>Name</i> text box. If the typed name finds a match in the database, its data is displayed on the spreadsheet.
Description	The description is a field for text intended to contain added information about the property.
Thickness	Use this column to accept or edit the physical thickness of the layer in microns.
Material Catalog	Use this column to accept or edit the name of an available catalog.
Material Name	Use this column to accept or edit the name of a material.

Thin Film Stack Editing Note

The thin film stack is a special case because it is subordinate to surface properties. That is, after creating a stack property with the thin film stack editor, the next step is to open the surface property editor to use the stack property in a surface property. In the Surface Property Editor, set the type = stack. You can now add scatter, which is not available in the Thin Film Stack Editor. By becoming part of a surface property, the stack property is enhanced with scatter before being applied to a surface. The sequence of steps is:

1. Create the Stack Property in the Stack Property Editor.
2. Create the Surface Property in the Surface Property Editor.
Set the type = Stack.
3. Apply the Surface Property to a surface in your model.

Entering a Single Layer Stack

Many lenses are coated with a single layer of Magnesium Fluoride (MgF), a common Anti-Reflection coating in the visible wavelength region. Typically this is a Quarter Wave Optical Thickness (QWOT) in the center of the visible spectrum. For maximum transmission at a given wavelength, select a physical thickness of $0.25 \lambda/n$ to achieve a Quarter Wave Optical Thickness.

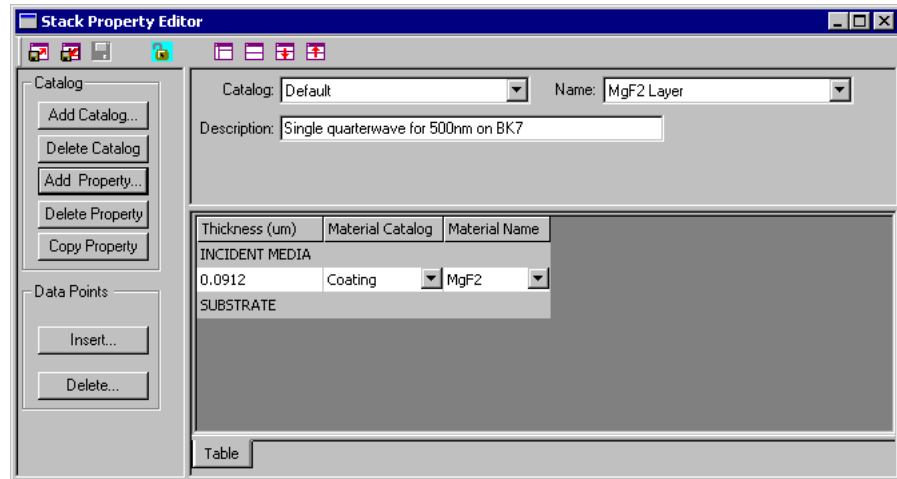

FIGURE 3.26 - Stack Property Editor

To create a Thin Film Stack:

1. Select **Define | Edit Property Data | Thin Film stacks** to open the Stack Editor editor window.
2. Choose a catalog from the catalog dropdown list.
3. Click on **Add Property**, enter a name for your new property and click OK.
4. Edit the Thickness and Material for each layer in the stack. The data columns are drop down lists from which a Catalog and THEN Name are selected.
5. Press the Insert or Delete buttons to add/remove layers.
6. Select **File | Save** from inside the Stack Property editor window or close the Stack Property editor and answer yes to the question “property has changed, save data?” Your new property is now available in the Property Database for future use.

Note: Because the Material Property Database is used, the Stacks are fully dispersive when the Material Data contains wavelength and temperature data.

After a Thin Film Stack is defined access the Surface Property Editor by selecting **Define | Edit Property Data | Surface Property** to define a Surface Property of type Stack. For more information about “Creating a new surface property”, see page 3.29.

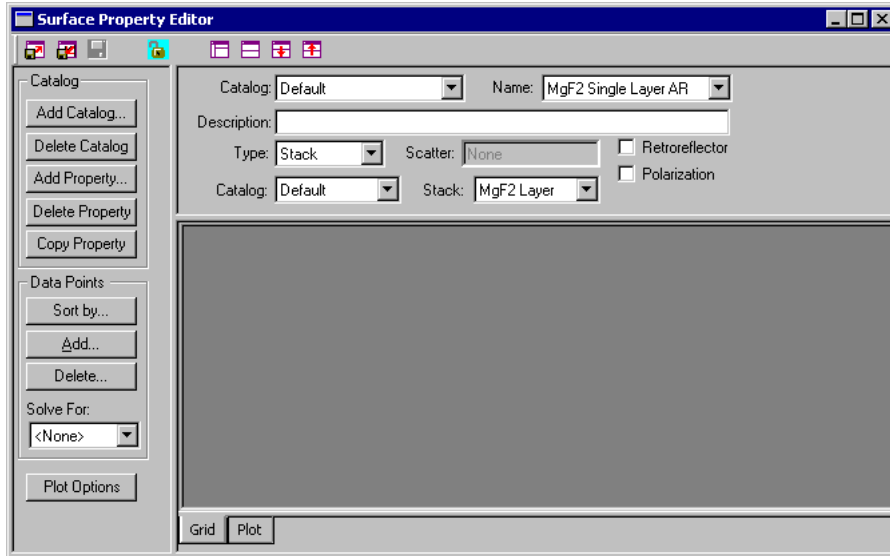

FIGURE 3.27 - Stack Entered Into Surface Property Editor

When the AR Surface Property is applied to an Object made from Schott BK7 glass, we see a reflectance of less than 4% in the visible wavelength range. An uncoated piece of BK7 has a reflectance of just over 4%. See Figure 3.28 on page 3.47. The plot is viewed by opening the Plot Tab in the Surface Property Editor and setting the Plot Options for an Incident Medium of Air and a Substrate of Schott BK7 glass. For more information about “Surface Property Plot Tab”, see page 3.30.

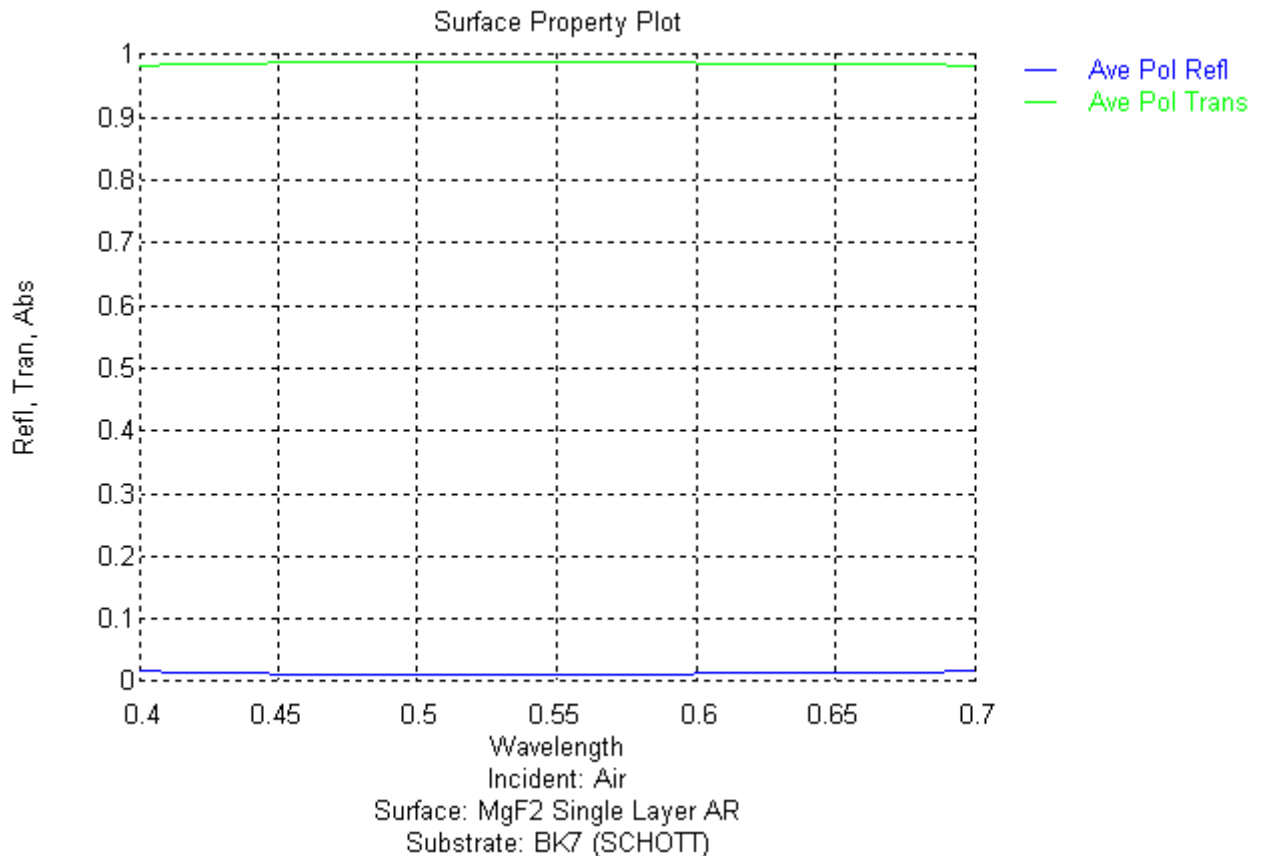

FIGURE 3.28 - Reflectance after the AR Surface Property is Applied to the Schott BK7 Glass

BSDF Properties

The BSDF Property Editor allows you to make “free-standing” BSDF properties that are not part of a surface property. BSDF Properties cannot be applied directly to a surface like a surface property. Instead, they are used to define the scattering part of a surface property rather than creating the BSDF ad hoc in the surface property. Using BSDF Properties in a Surface Property gives you added flexibility, because you can use more than one BSDF property when defining a surface property. TracePro will add the BSDF properties together to make a composite BSDF. This allows you, for example, to combine 1D and 2D BSDFs together in one surface property, or use more than one BSDF model to fit measured data. For example, the ABg model may not fit your measured data well, but two ABg models with different coefficients, added together, may work well.

Another advantage of defining BSDF in a BSDF Property instead of a Surface Property, is that you can use a different set of independent variables in the BSDF Property. For example, it is easy to measure transmittance and reflectance at many wavelengths using a spectrometer, but BSDF is normally measured at only a few wavelengths, because BSDF does not typically vary rapidly with wavelength, and BSDF measurements are expensive for even a few wavelengths.

All of the Scatter Model types available in the BSDF Property database are also available as ad hoc Scatter Models in the Surface Properties database, and vice versa. For complete descriptions of all the BSDF models supported by TracePro, see the Technical Reference section.

Using the BSDF Property Editor

The BSDF Property Editor provides a means to add or change a BSDF property. Select **Define | Edit Properties | BSDF Properties** to open the BSDF Property Editor window. To create a new BSDF property, click the Add button and fill in the items in the Enter New BSDF Property dialog box, as shown in Figure 3.29.

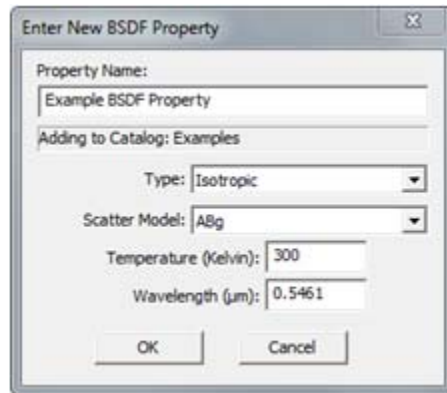

FIGURE 3.29 - Adding a new BSDF Property using the Enter New BSDF Property dialog box. ABg BSDF is shown.

The BSDF Property Editor is similar in appearance to the Surface Property Editor. Figure 3.30 shows the Editor displaying a property with an ABg scatter model and one temperature, wavelength, and incident angle.

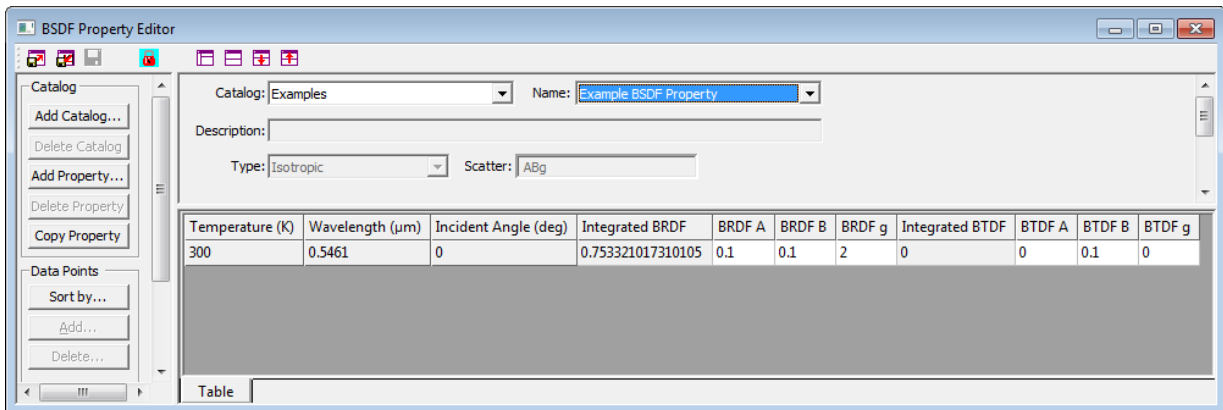

FIGURE 3.30 - The BSDF Property Editor with an ABg scatter model and one wavelength, temperature, and incident angle.

To edit an existing property, first select the Catalog and Name from the lists to display the data for the property you wish to edit. Then click the lock icon in the toolbar at the top of the Editor window, as described on page 3.3.

Importing and Exporting BSDF Properties

You can import and export BSDF properties as text files using the toolbar icons, in the same way as for any other property, as described on page 3.3. Properties can also be exported using the File menu. The File menu also enables you to export a catalog as a text file.

RepTile Surfaces Expert

Overview

When modeling objects that have many small repeated structures, it is often infeasible to create the structures using TracePro or any other solid modeling program. For example, brightness-enhancing films used in flat-panel LCDs may have thousands or millions of repeated surface structure elements. There are two ways to model such systems effectively via optical analysis in a timely manner: inclusion of a BSDF scatter function or implementation of a functional form for the shape and distribution of the replicated structure. The former is adequate for systems working in the far field, but for almost all systems it is better to use the latter functional form. The RepTile surface feature in TracePro accomplishes this by allowing you to create these objects by specifying the shape of one tile, and the RepTile feature replicates this shape to create an array of tiles. This feature allows you to create complicated models with a great reduction in model size, audit time, and ray-trace time compared to equivalent models with solid geometry.

To see how to define and use RepTile properties see “RepTile Examples” on page 9.1.

Specifying a RepTile surface

The process of making a RepTile surface in TracePro is analogous to applying a surface property. TracePro has a database of basic RepTile surface shapes and geometries, and you can define additional RepTile parameters by adding them to the database. The database is accessed through the RepTile Property Editor. Different tile shapes (ring, segmented ring, rectangular, staggered rectangular, and hexagonal) and tile geometries (conical, spherical, hip-roof, cube-corner, prism, rounded prism, and Fresnel lens) are available. These tile shapes and geometries are explained in the following sections. In general, the geometries can be defined as either “bumps” or “holes”.

Once a RepTile property is entered in the database, it can be applied to a plane surface using the RepTile tab of the Apply Properties dialog box. Additionally, applying a RepTile requires boundary data for the plane surface within which the tiles are to exist and the location of a key reference tile (0,0).

When you apply a RepTile surface to a plane surface, TracePro defines a cell containing the tiled space. The cell has the shape of the boundary (circular, rectangular, or the boundaries of the surface) and a depth. You must be aware of the depth calculation because the cell must be completely contained within the object that owns the RepTile surface. If this rule is violated, incorrect rays result.

The orientation of tiles in a RepTile surface is specified by the Up Vector. It defines the local y axis of the surface, the plane normal vector defines the local z axis, and the local x axis is orthogonal to the y and z axes and forms a right-handed coordinate system. The width of tile shapes and geometry is the dimension along the local x axis and the height is along the local y axis (the Up Vector). Depth/height of holes/bumps is along the local z axis. Please note that the “Bump” will be below the selected surface, not above it and external to the object.

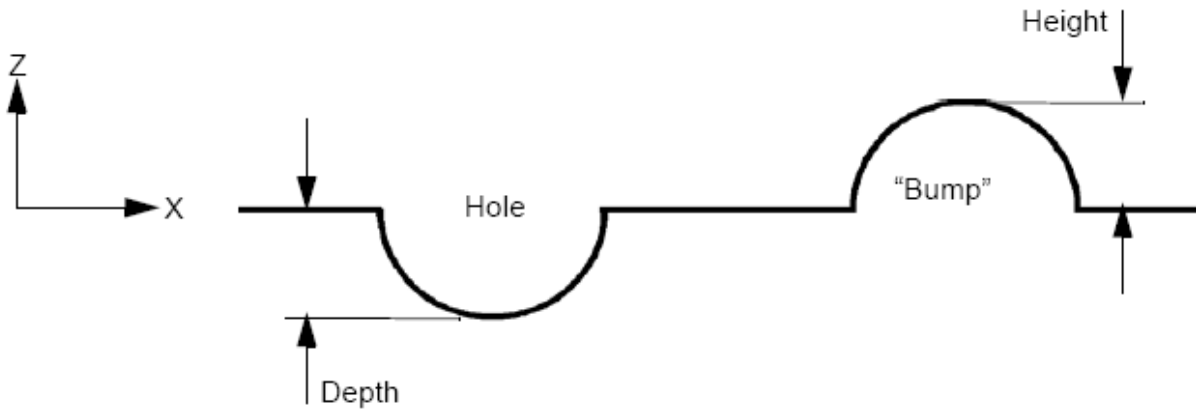

FIGURE 3.31 - Orientation of dimensions along the z-axis.

RepTile Shapes

The tile shapes in a RepTile surface can be one of the following:

- Ring
- Segmented Ring (Parameterized Ring tile)
- Rectangular
- Staggered Rectangular
- Hexagonal

Ring tiles

Ring tiles are simply concentric rings defined by their width. The central ring tile is a circle of radius r_0 . Ring tiles are used for specifying Fresnel lenses. The location of the (0,0) tile is the center of the rings.

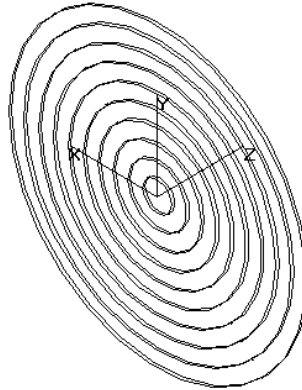

FIGURE 3.32 - Example of ring tiles geometry.

Segmented Ring tiles

Segmented Ring tiles are defined by a radial ring width, an angular segment width, a starting angle and the number of angular segments per ring. The segment width and number of segments are independent parameters. If the segment angular width multiplied by the number of segments is less than 360 degrees, then TracePro will create a final tile to complete the full 360 degrees. This final tile will have no Reptile geometry. If the segment angular width multiplied by the number of segments is greater than 360 degrees, then TracePro will truncate the tiles and thus the geometry at 360 degrees. Figure 3.33 shows an example of segmented ring tiles.

See "RepTile Parameterization" on page 3.77 for further discussion on this topic.

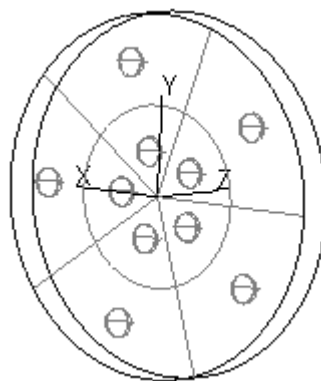

FIGURE 3.33 - Example of segmented ring tiles with spherical hole geometry.

Rectangular tiles

Rectangular tiles are rectangular in shape and are laid out in a rectangular array. Figure 3.34 shows an array of rectangular tiles with conical "bump" geometry. Rectangular tiles are specified by their height and width.

See "RepTile Parameterization" on page 3.77 for further discussion on this topic.

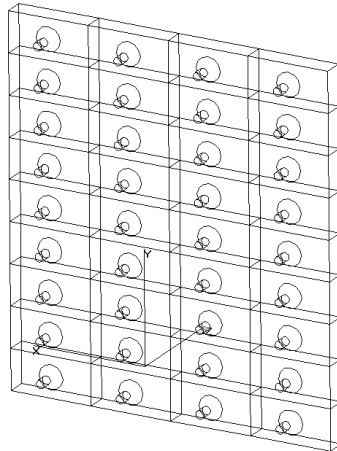

FIGURE 3.34 - Example of rectangular tiles with conical "bump" geometry.

Staggered rectangular tiles

Staggered rectangular tiles are similar to rectangular tiles except that alternate rows of tiles are displaced by one-half the tile width, like brickwork. An example of staggered rectangular tiles with conical "bump" geometry is shown in Figure 3.35. You specify staggered rectangular tiles by their height and width. Note that for Constant (C) or Variable Rows (V) variation types, succeeding rows are staggered by half the tile width. For Parameterized (P) variation type, you must enter the stagger value with the use of the iRow variable in the Row Offset data entry point. Failure to do so, results in a non-staggered array of rectangles. This Row Offset value allows you to vary the stagger as a function of row number, in fact, it can be nonlinear dependent on the function that you enter for the Row Offset.

See "RepTile Parameterization" on page 3.77 for further discussion on this topic.

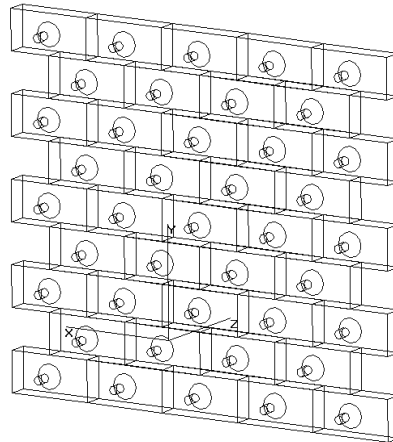

FIGURE 3.35 - Example of staggered rectangular tiles with conical "bump" geometry.

Hexagonal tiles

Hexagonal tiles are packed hexagons, like a honeycomb. The width of a hexagon is the distance from one flat side to another and lies along the local x-axis as shown in Figure 3.36. The hexagons are packed with points along the vertical direction defined by the local y-axis or up vector as shown in Figure 3.36.

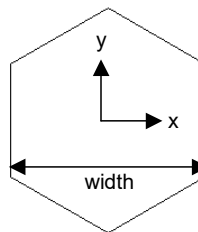

FIGURE 3.36 - Hexagonal tile with local x and y axes and width parameter

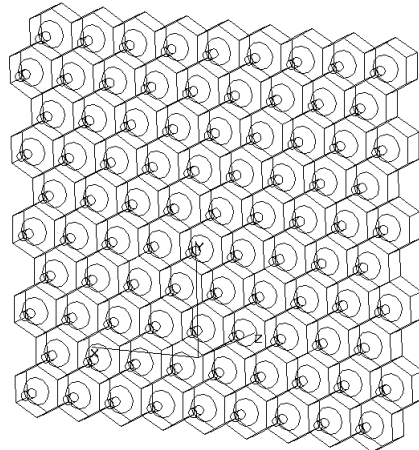

FIGURE 3.37 - Example of hexagonal tiles with conical "bump" geometry.

RepTile Geometries

Several geometries are available for defining tiles in RepTile surfaces; more will be added as TracePro evolves. Most geometries can be defined as either bumps or holes. Bumps protrude out from the surface and holes protrude into the surface. Geometry can also vary from one row to the next or from one ring to the next. Not all geometries are compatible with all tile shapes. The compatibility of geometry and tile shapes is summarized in Table 3.13 and it includes other facets of the RepTile interface: "bump"/"hole" compatibility, decenter within the tile, variance from row/ring, and parametrization capability.

The Tile Shape vs. Geometry portion of the table uses the following legend to indicate which of the three Variation types is supported:

- C - Constant,
- V - Variable rows,
- P - Parameterized,
- N/A - Not Applicable.

If the cell is left blank, the Shape/Geometry combination is not available.

TABLE 3.13 - Compatibility of geometry and tile shapes and also factors that define the shape and placement of the "bump"/hole.

Geometry	"Bump"/ Hole	Decenter within tile	Can Vary versus Row/ring	Can be para- meterized	Tile shape		
					Ring/ Segmented ring	Rectangle/ Staggered rectangle	Hexagonal
Fresnel Lens	X		X	X	C,V,P		
Cone	X	X	X	X	P	C,V,P	C
Sphere	X	X	X	X	P	C,V,P	C
Ellipsoid	X	X	X	X	P	C,V,P	C
Hip Roof	X	X	X	X	P	C,V,P	
Prism	X		X	X		C,V,P	
Rounded Prism	Bump		X	X		C,V,P	
Enhanced Prism	X	X	X	X	X	C,V,P	
Log	X	X	X	X	X	C,V,P	
Flattened Cone	X	X	X	X	X	C,V,P	C
Pointed Cone	X	X	X	X	X	C,V,P	C
Block	X	X	X	X	X	C,V,P	C
Chiseled Log	X	X	X	X	X	C,V,P	C
Cube Corner	Bump						C
DMD Mirror	X	X	X	X	P	C,V,P	
Torus	X	X	X	X	P	C,V,P	C
Asphere	X	X	X	X	P	C,V,P	C
Polygon	X	X	X	X	P	C,V,P	C
Pyramid	X	X	X	X	P	C,V,P	C
Texture File	X	N/A	N/A		N/A	N/A	N/A
Circular Hip Roof	X	X	X	X	P	C,V,P	C

Note: Fresnel lens geometry is described by rings rather than individual bumps or holes.

Most geometry can be parameterized and decentered within the tiles. These functions are described in “RepTile Parameterization” on page 3.77 and “Decentering RepTile Geometry” on page 3.82.

It is possible for you to define geometry that will produce incorrect ray-tracing results. These situations are described as they arise in the following sections.

Fresnel lens geometry

The Fresnel lens geometry is limited to linear facets. The first provides the optical power for the conical facets, while the second provides for draft facets. The Fresnel lens geometry has three selections: constant ring, variable rings, or parameterized rings. With these choices the linear facet angles can be different or constant for each ring. By specifying the "bump" geometry a Fresnel lens with positive power is obtained, while the "hole" geometry provides a Fresnel lens with negative power.

In order to remove the possibility that rays will have undefined behavior at the boundary of the tiled region, the rings must completely fill the region. The standard is for centered Fresnel lenses - when the center of the boundary and the location of the (0,0) tile have the same coordinates. Decentered Fresnel lenses are created by making these two coordinates different, but as stated previously, one must ensure that the entire region is filled by the specified rings.

The Fresnel lens geometry and tile shapes must be defined so that they vary versus ring, and there must be enough rings to completely fill the boundary. Otherwise, rays will have undefined behavior at the edge of the outermost ring.

To make a centered Fresnel lens, enter the same coordinates for both the center of the boundary and the location of the (0,0) tile. You can make “decentered” Fresnel lenses by making the center of the boundary different from that of the (0,0) tile.

Conical geometry

Conical geometry consists of a truncated cone and an optional chamfer. As shown in Figure 3.38, you specify the end radius of the cone, the angle of the cone, the height of the cone, and optionally the height and angle of the chamfer. The cone and optional chamfer protrude from a base plane. To make conical “bumps” or “holes” that overlap or “run into” each other, specify a combination of cone radius, chamfer height, and chamfer angle such that the chamfer does not fit within the tile. If you choose to do this, the geometry must not vary versus row, or surface discontinuities will result. Conical geometry can be used with ring, segmented ring, rectangular, staggered rectangular, or hexagonal tiles.

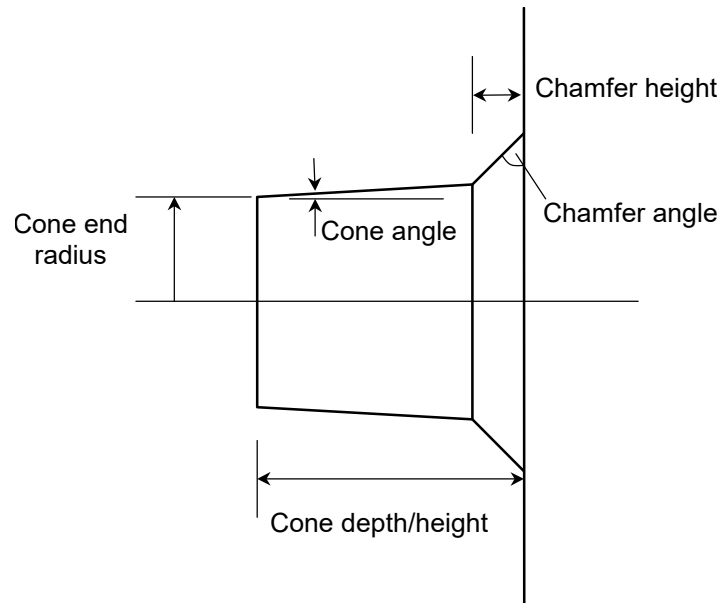

FIGURE 3.38 - Parameters for defining conical geometry.

Spherical geometry

Spherical geometry consists of a spherical "bump" or "hole" and a base plane. Specify a spherical "bump" by its height above the base plane and the radius of the sphere. The depth/height of the "bump"/"hole" can exceed the radius allowing for bubbles or floating spheres respectively. To make spherical bumps or holes that "run into" each other, e.g., an array of lenslets, specify a height and radius large enough that the sphere does not intersect the base plane within the tile. The dimensions needed to specify spherical geometry are illustrated in Figure 3.39. Spherical geometry can be used with ring, segmented ring, rectangular, staggered rectangular or hexagonal tiles.

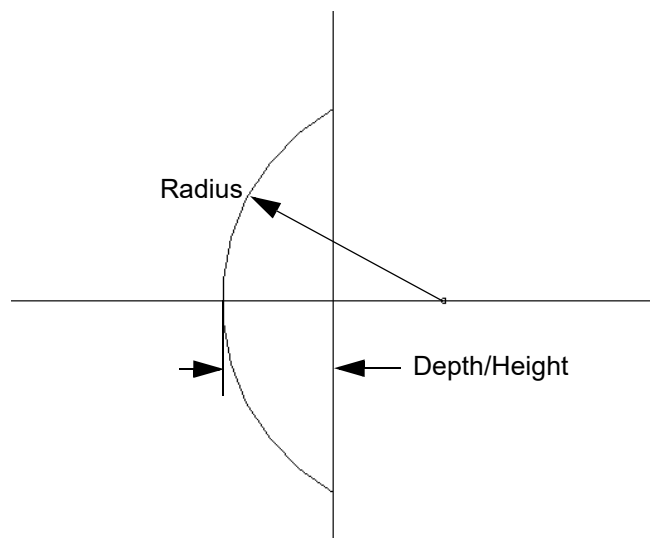

FIGURE 3.39 - Parameters for specifying spherical geometry.

Ellipsoid geometry

Ellipsoid geometry consists of an elliptical "bump" or hole and a base plane. The ellipsoid is defined by three radii along a local x-axis, y-axis, and z-axis. Z is defined normal to the plane of the surface to which the property is applied. Y is defined by the Tile Up vector. Three rotations are also available to rotate the ellipsoid about the x-axis, y-axis and z-axis. Ellipsoid geometry can be used with ring, segmented ring, rectangular, staggered rectangular or hexagonal tiles.

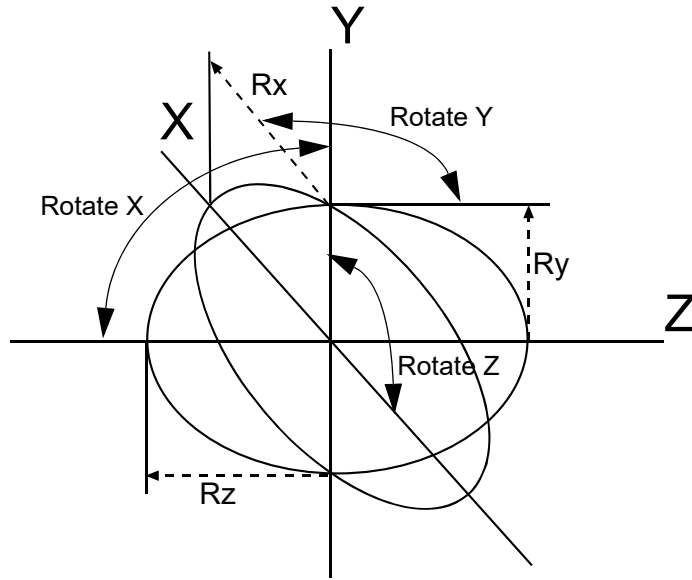

FIGURE 3.40 - Dimensions for Ellipsoid geometry. The X-Y plane is the base plane.

The position of the base plane allows control of the height/depth of the ellipsoid above/below the surface. A positive value for the base plane height positions the center of the ellipsoid above the surface, while a negative base plane height positions the center of the ellipsoid below the surface. If the Variation Type for the property is specified as parameterized, then the base plane height can exceed the

Z Radius, so the RepTile feature can be a complete ellipsoid floating above the surface, or an embedded ellipsoid within the surface. See Figure 3.41.

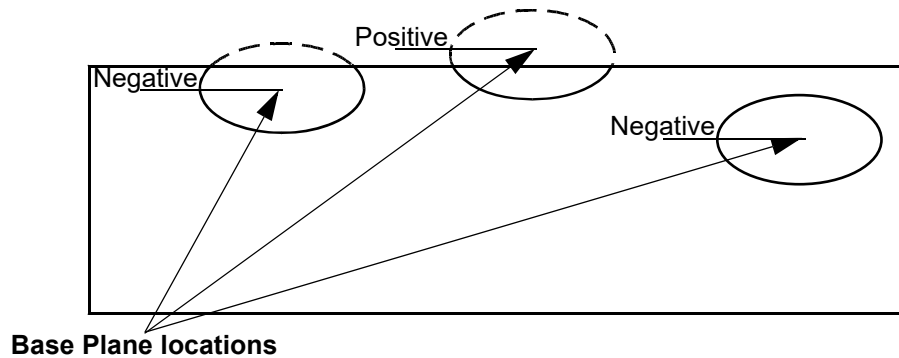

FIGURE 3.41 - Effect of base plane height on Ellipsoid hole geometry.

Hip-roof geometry

The Hip-Roof geometry consists of a pyramid that can come to a point, a linear edge, or a plateau dependent on its entered parameters, which are:

- the x and y angles, which do not need to be the same,
- the x and y widths of the angled sides, which do not need to be the same,
- the x and y widths of the flat borders, called landings, which do not need to be the same, and
- the truncation amount to provide a flat roof.

The dimensions needed to specify a hip roof are shown in Figure 3.42, and the dimensions for a mansard roof are shown in Figure 3.43. If the depth/height specified for the hip roof geometry is less than the intersection of the angled planes, the top is truncated and a mansard roof is created. Otherwise, a hip roof is created. To make tiles that “run into” each other, make the x and/or y border zero.

Hip-roof geometry can be used with ring, segmented ring, rectangular or staggered rectangular tiles.

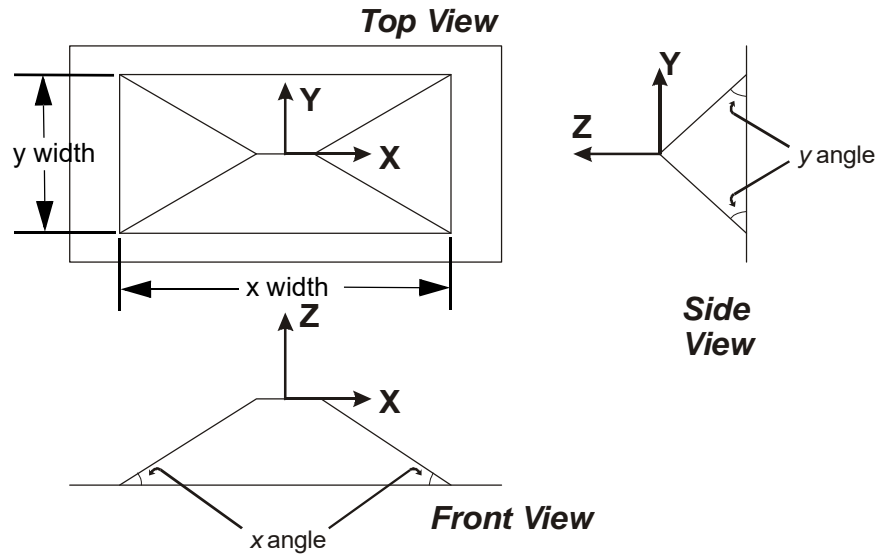

FIGURE 3.42 - Hip-roof "bump" geometry showing front, side and bottom views. The local coordinate axes are shown in each view. The outer rectangle in the front view is the rectangular tile. In this example the y angle is 45 degrees and the x angle is 30 degrees.

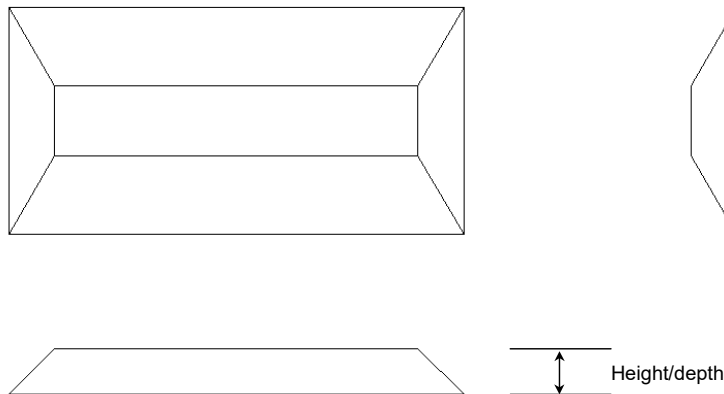

FIGURE 3.43 - Mansard roof tile showing the effect of truncating the roof. In this example, the x and y borders are both zero. The y angle is 30 degrees and the x angle is 45 degrees.

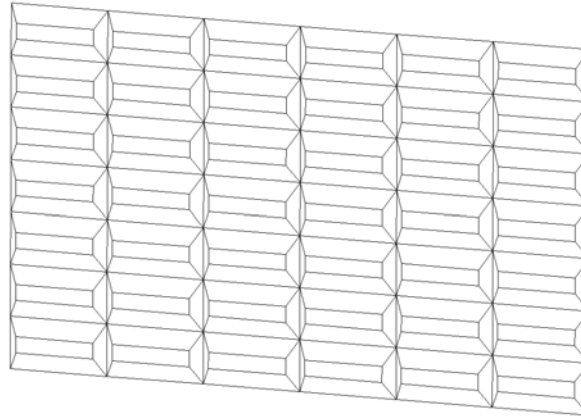

FIGURE 3.44 - A surface tiled with the mansard roof tile illustrated in Figure 3.43. The x and y borders are zero, so there is no flat region between the tiles.

Note: To make this RepTile geometry compatible with some of the Parameterization RepTile features now available (e.g., to resolve situations where the “border” may no longer be constant), the parameters defining a Hip (Mansard) Roof RepTile Property have changed to include an X width and Y width replacing the X border and Y border. Older property definitions are automatically converted as follows:

- X width = Width - 2 * X border
- Y width = Height - 2 * Y border

Prism geometry

Prism geometry consists of a pyramidal shape that can have different leading and trailing “x” angles (x_0 and x_1) as well as different leading and trailing “y” angles (y_0 and y_1). The dimensions needed to specify prism geometry are shown in Figure 3.45. Note that unlike the hip roof geometry, the prism geometry has no borders or “landings”. The angles can be defined such that the prism looks “offset” in the individual tile. Because of this, the center of the tile might not coincide with the peak of the prism. To make prisms that “run into” each other and make a continuous prism roof line, make sure the faces mating with the neighboring tiles are defined with angles of 90° . All four angles can vary within a given column of

tiles. Prism geometry can be used only with rectangular or staggered rectangular tiles.

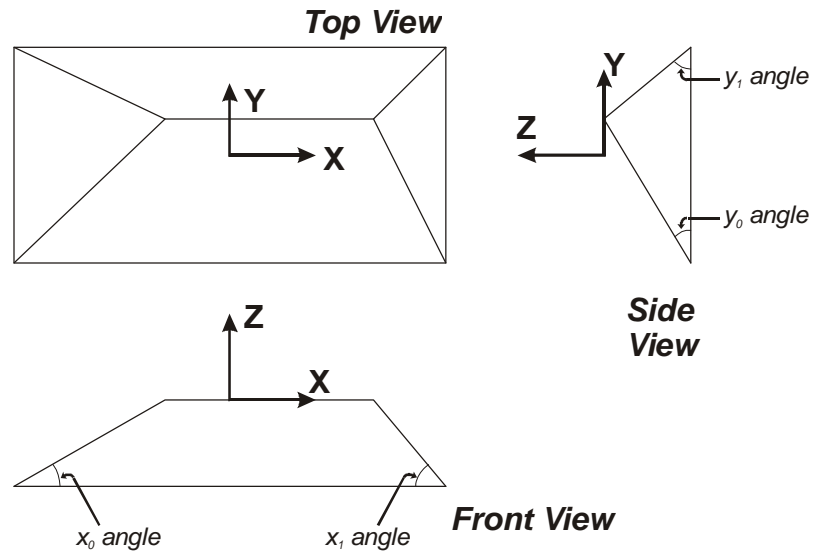

FIGURE 3.45 - Prism geometry showing top, side and front views. The local origin and coordinate axes are shown in each view. Due to the angles chosen, the local origin does not line up with the “peak” of the prism structure.

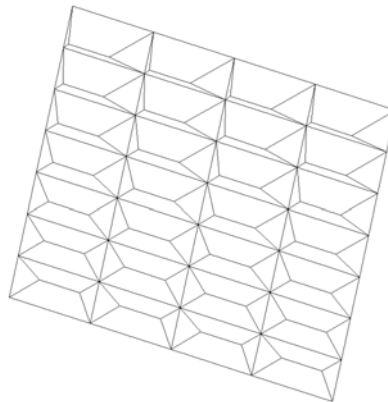

FIGURE 3.46 - A surface tiled with the Prism geometry illustrated in Figure 3.45. Note that all four facet angles change as a function of row, so all tiles vary in appearance from the top to the bottom of this figure.

Rounded prism geometry

Rounded prism geometry consists of a cylindrical triangular shape that can have a different leading and trailing y angle (y_0 and y_1), but with no angles in the x direction. The dimensions needed to specify a rounded prism geometry are shown in Figure 3.47. Note that unlike the Hip-Roof geometry, the rounded prism geometry has no borders or “landings”. Also, unlike the prism geometry, the “x” angles are limited to 90° . The “y” angles can be defined such that the prism looks “offset” in the individual tile. Because of this, the center of the tile might not coincide with the peak of the prism. The angles can vary within a given column of tiles. Prism geometry can be used only with rectangular or staggered rectangular

tiles. The raytrace will go faster if there is only one column of tiles - i.e. if the tile width (x direction) is greater than or equal to the RepTile boundary width (defined with Define|Apply Properties|RepTile).

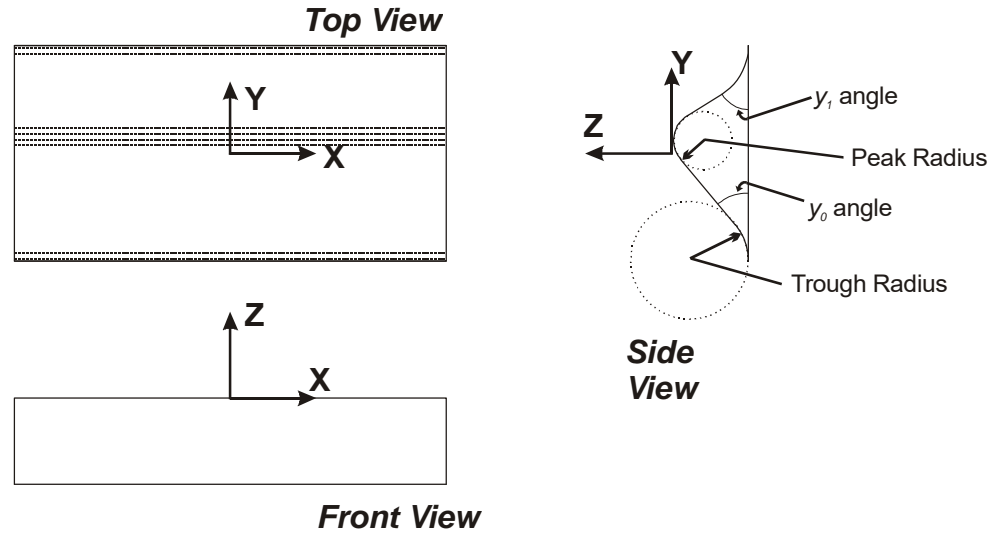

FIGURE 3.47 - Rounded Prism geometry showing front, side and top views. The local origin and coordinate axes are shown in each view. Due to the angles chosen, the local origin does not line up with the “peak” of the prism structure.

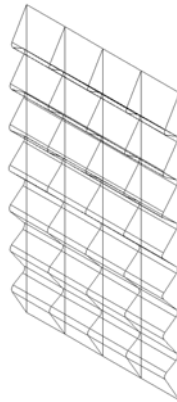

FIGURE 3.48 - A surface tiled with the rounded prism illustrated in Figure 3.47. No “x” angles can be defined when using a rounded prism so the prism “roof” lines are continuous. Note that the angles change as a function of row, so all tiles vary in appearance from the top to the bottom of this figure.

Enhanced Prism geometry

The Enhanced Prism Geometry combines the features of the Hip Roof, Prism, and Rounded Prism geometries. It has a rectangular footprint as specified by x width and y width, so it may have a flat “landing” on one or more sides like the Hip Roof geometry. All four faces can have different angles like the Prism geometry, and it may have a flat roof like the Hip Roof Geometry. It may have rounded peaks and troughs for the y-angled faces like the Rounded Prism geometry. Because the Enhanced Prism may have landings and a flat roof, there are four different radii to specify, two for the “troughs” and two for the “peaks.” Finally, if the height specified for the Enhanced Prism is greater than the intersection height of the y planar sides, the second peak radius is ignored, and the peak appears as for the Rounded Prism geometry.

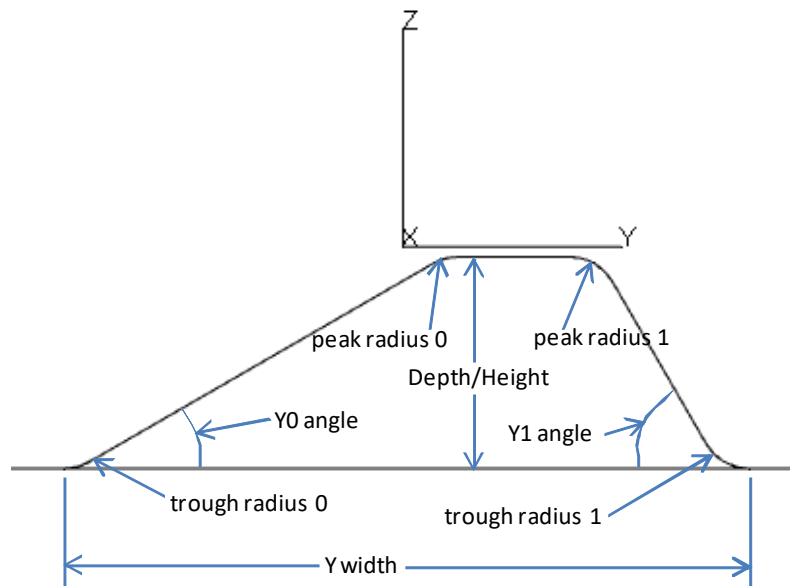

FIGURE 3.49 - Enhanced Prism geometry showing Y-Z profile for “bump” geometry. Due to the angles chosen, the local origin does not line up with the center of the roof of the prism structure.

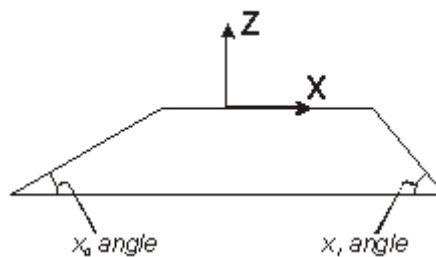

FIGURE 3.50 - Enhanced Prism X-Z profile view, showing X0 and X1 angles for bump geometry.

Log geometry

The Log geometry is so called because it is like a log floating in water. The Log is a frustum of a cylinder or cone nominally lying on its side, and its depth and orientation can be specified. The orientation is controlled by rotation angles about the x, y, and z axes. With all rotation angles equal to zero, the axis of the log is along the local x axis. The cylinder or cone may also be elliptical in cross-section. With all rotation angles equal to zero, a Radius Ratio greater than one puts the long axis of the ellipse along the Z axis.

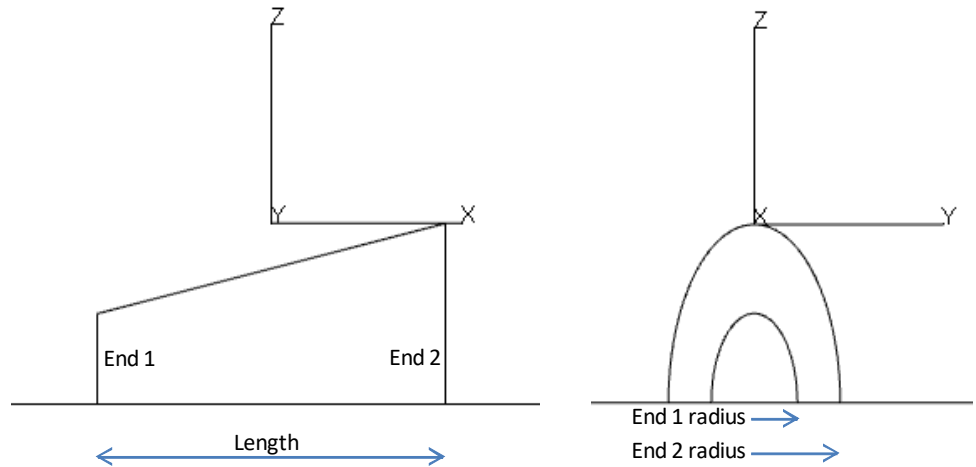

FIGURE 3.51 - Log “bump” geometry showing X-Z and Y-Z views. The log shown has a Radius Ratio of 2, putting the long axis of the elliptical cross-section along the Z axis.

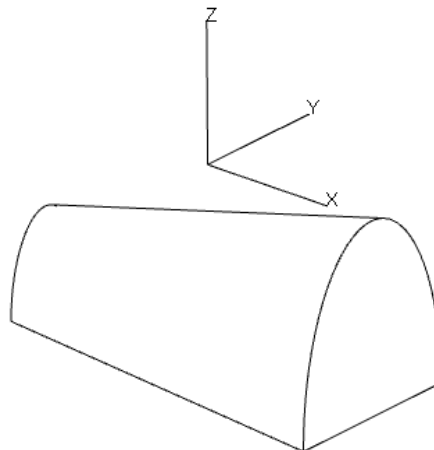

FIGURE 3.52 - Log “bump” geometry oblique view.

Flattened Cone geometry

The Flattened Cone geometry is like Cone geometry, but with no chamfer and rounded top and bottom edges. The inputs for a Flattened Cone are end radius,

depth/height, cone angle, peak radius, and trough radius. For parameterized geometry, you can also enter decenter in x and y.

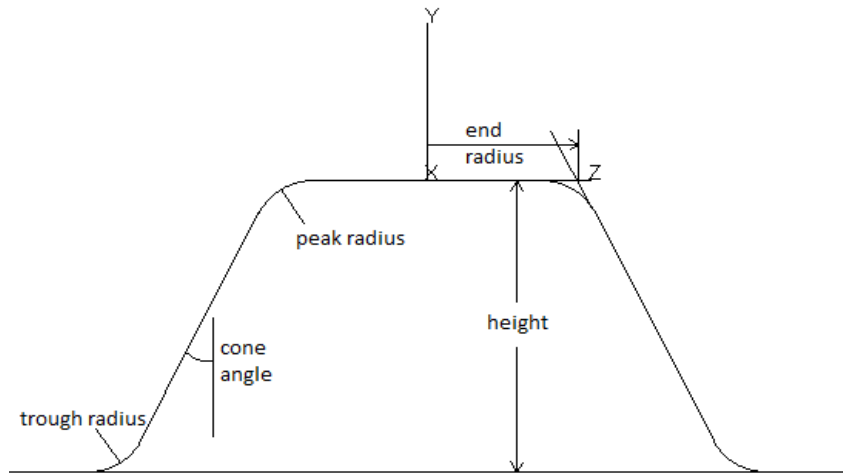

FIGURE 3.53 - Flattened Cone “bump” geometry.

Pointed Cone geometry

The Pointed Cone geometry is an inverted cone, with point facing up for bump geometry or down for hole geometry, and rounded point and trough. The inputs for a Pointed Cone are depth/height, cone angle, peak radius, and trough radius. For parameterized geometry, you can also enter decenter in x and y.

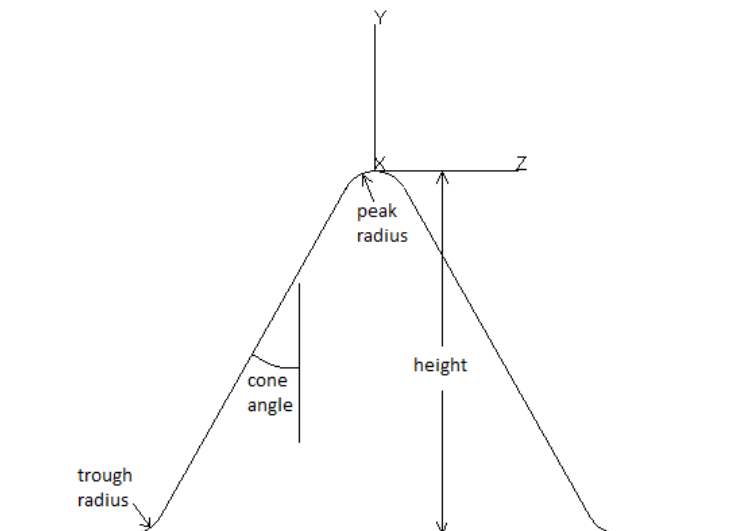

FIGURE 3.54 - Pointed Cone “bump” geometry.

Block geometry

Block geometry is used to create a block that floats above the base plane (bump geometry) or is embedded below the base plane (hole geometry). The block can be rotated to any orientation.

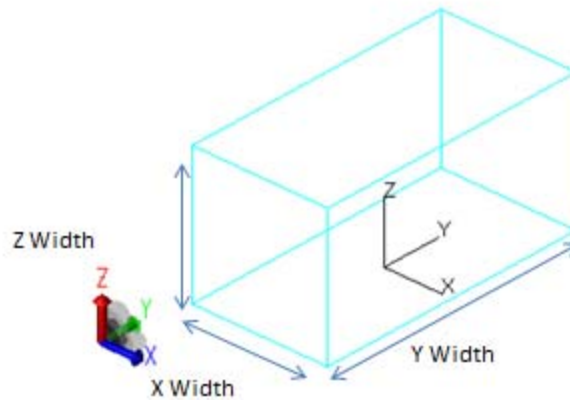

FIGURE 3.55 - Block dimensions.

To create block RepTile geometry, you specify center depth/height, X width, Y width, Z width, X rotation angle, Y rotation angle, Z rotation angle, and for parameterized geometry, decenter in X and Y (or R and phi for ring tiles).

The block is rotated about its center point, about the X, Y and Z axes in turn.

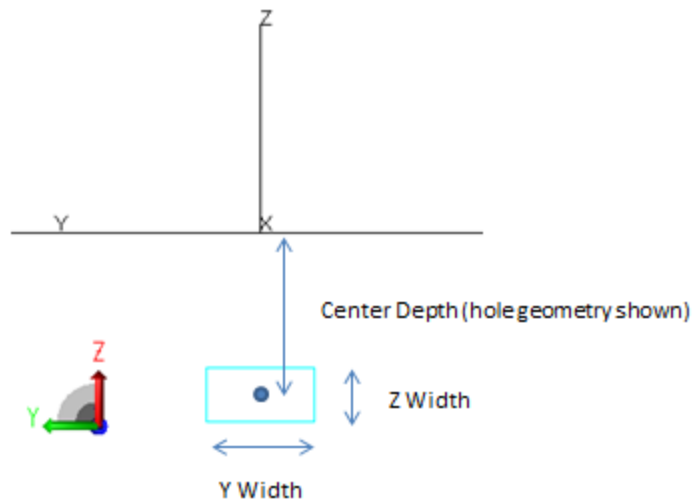

FIGURE 3.56 - Block depth/height and rotation center.

Chiseled Log geometry

Chiseled Log geometry is a frustum of an elliptical cone with ends that are optionally cut or chiseled at an angle. The Chiseled Log can be made as either a bump or a hole. It can be rotated in the x-y plane as well.

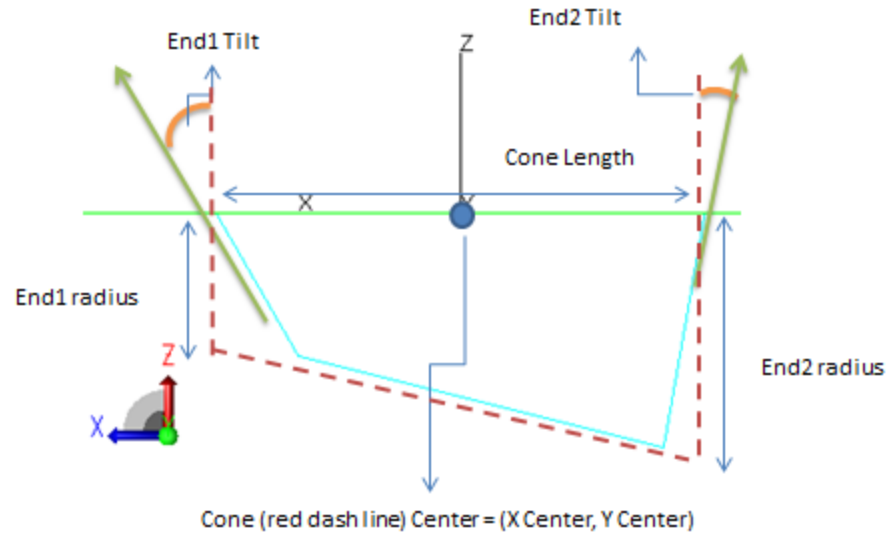

FIGURE 3.57 - Chiseled Log dimensions.

To create Chiseled Log geometry, you specify center depth/height, length, end 1 and end 2 radii, end 1 and end 2 tilt angle, radius ratio (for an elliptical cone) orientation angle (rotation about the Z axis), and for parameterized geometry, decenter in X and Y (or R and phi for ring tiles).

The radius ratio is the radius along the z direction divided by the radius in the x-y plane.

DMD Mirror geometry

DMD Mirror geometry is used to model the individual reflectors in a Digital Micromirror Device (DMD).

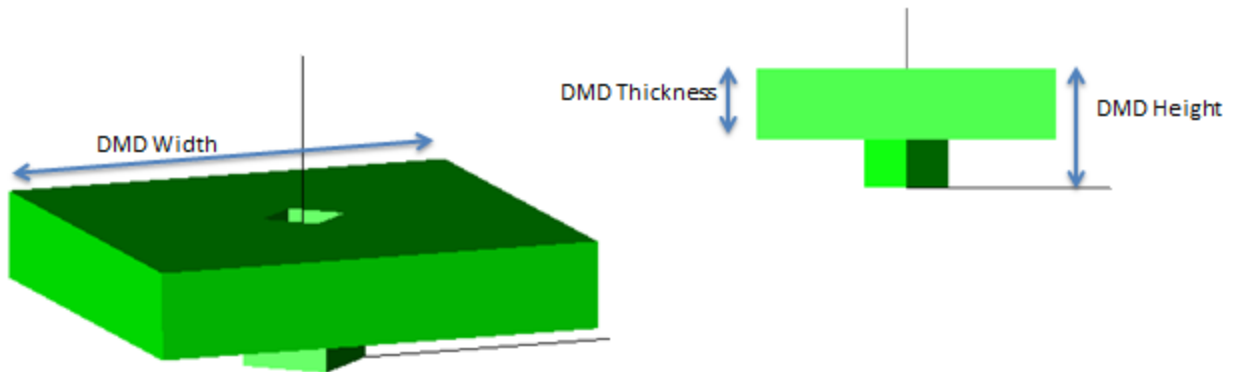

FIGURE 3.58 - DMD Mirror geometry.

DMD Mirror geometry consists of a square mirror mounted on a square post, with an optional square hole in the center of the mirror, oriented at 45° to the mirror.

To create each DMD mirror, you specify the depth/height, thickness, width, hole width, post width, tilt angle, and for parameterized geometry, orientation angle and decenter in X and Y (or R and phi for ring tiles).

The mirror is tilted about the diagonal along the (1 1 0) direction in local coordinates (orientation angle = 0), with the center of rotation at the base of the mirror, as shown in Figure 3.60.

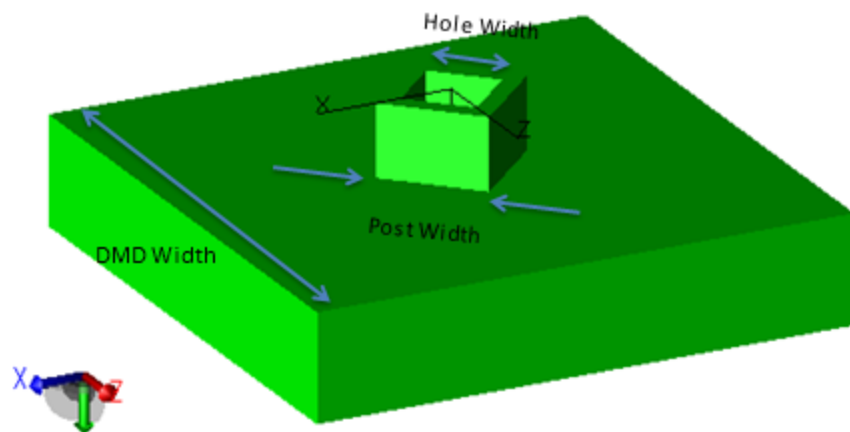

FIGURE 3.59 - DMD Mirror dimensions.

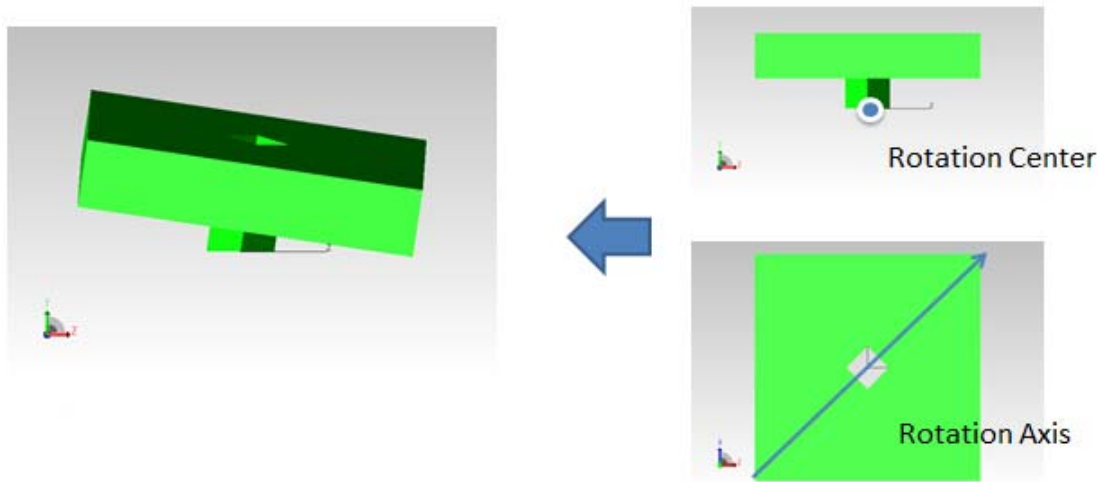

FIGURE 3.60 - DMD Rotation axis and rotation center.

Torus geometry

Torus RepTile geometry is specified by a major radius, minor radius, x center, y center, and depth/height. Parameterized tori can also be decentered in x and y.

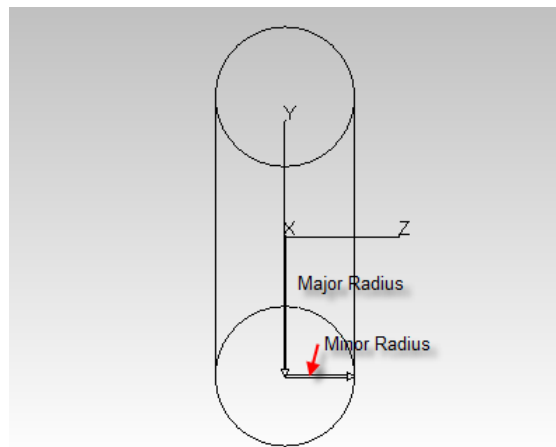

FIGURE 3.61 - Torus major and minor radii.

A torus can be specified as a normal ring-shaped torus as shown in Figure 3.61, or as a self-intersecting “apple” or “lemon” torus as shown in Figure 3.62. For a normal torus, the major radius is greater than the minor radius. For a self-intersecting torus, the major radius is less than the minor radius. For an apple torus, the major radius is positive, while for a lemon torus the major radius is negative. Attempting to make a torus with negative major radius with magnitude greater than the minor radius results in no surface at all.

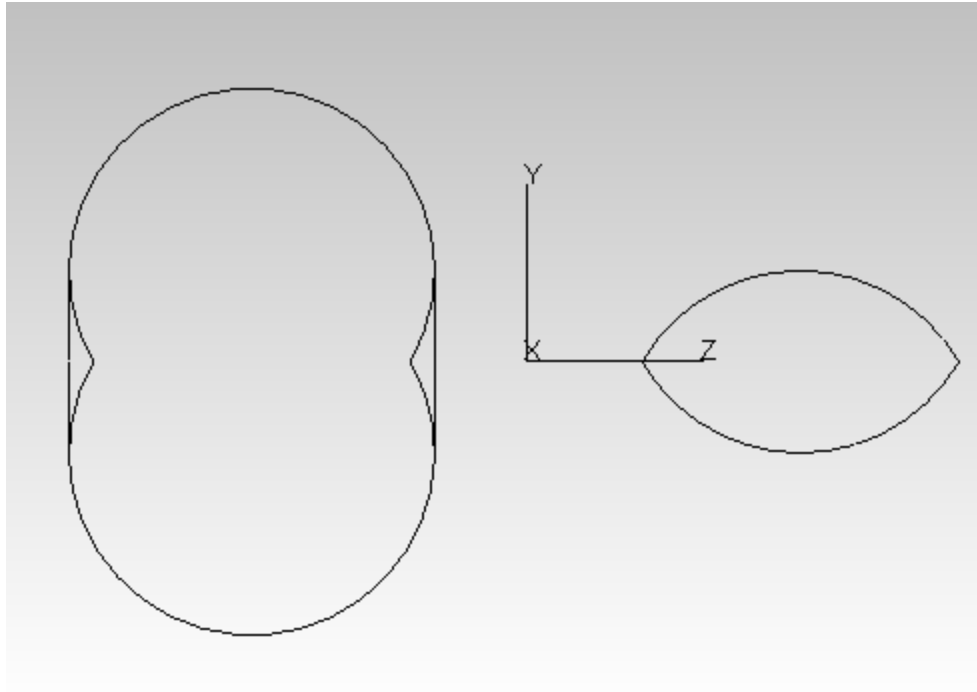

FIGURE 3.62 - Example of an apple torus (left, with major radius =1, minor radius = 2) and a lemon torus (right, with major radius = -1, minor radius = 2).

Asphere geometry

Asphere RepTile geometry is a single surface defined according to the rotationally symmetric lens surface sag equation,

$$z = \frac{c_v \rho^2}{1 + \sqrt{1 - (1 + K)c_v^2 \rho^2}} + \sum_{i=1}^8 A_i \rho^i, \quad (3.9)$$

where $\rho^2 = X^2 + Y^2$, c_v is the vertex curvature of the surface, K is the conic constant and A_i is an aspheric coefficient. The X, Y, Z coordinates above are local coordinates relative to the vertex of the surface.

To specify an aspheric surface, enter the radius (i.e. semi-diameter) of the surface, the vertex curvature, the conic constant, and the eight aspheric coefficients. You do not need to specify the height of the surface, as the height will be adjusted so that the circle defining the outer edge lies on the base plane of the RepTile cell. Therefore the vertex height of the surface is determined by the sag equation,

$$height = \frac{c_v R^2}{1 + \sqrt{1 - (1 + K)c_v^2 R^2}} + \sum_{i=1}^8 A_i R^i, \quad (3.10)$$

where R is the radius (semi-diameter) of the surface.

Polygon geometry

Polygon RepTile geometry is a solid regular polygon specified by the radius of a circle circumscribing the polygon, thickness, number of sides, x center, y center, depth/height, and (x,y,z) rotation angles. Parameterized polygons can also be decentered in x and y.

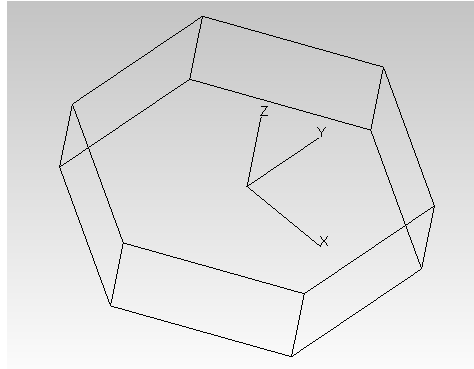

FIGURE 3.63 - Example of a six-sided regular polygon (hexagon) RepTile feature.

The depth/height specifies the distance from the base plane to the center of the polygon. For bump geometry, depth/height is the height above the base plane, and for hole geometry, depth/height is the depth below the base plane.

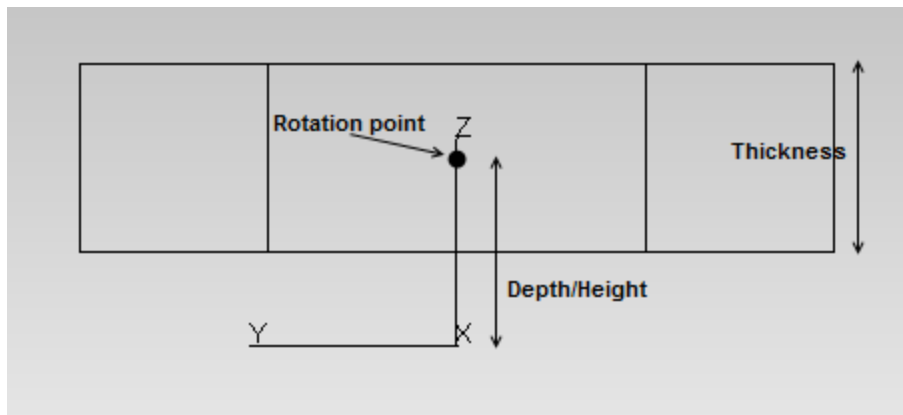

FIGURE 3.64 - Depth/Height, Thickness, and Rotation point of a polygon RepTile feature.

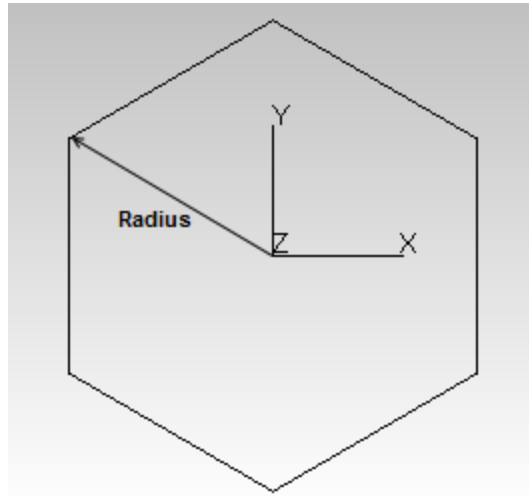

FIGURE 3.65 - Radius of a polygon RepTile feature.

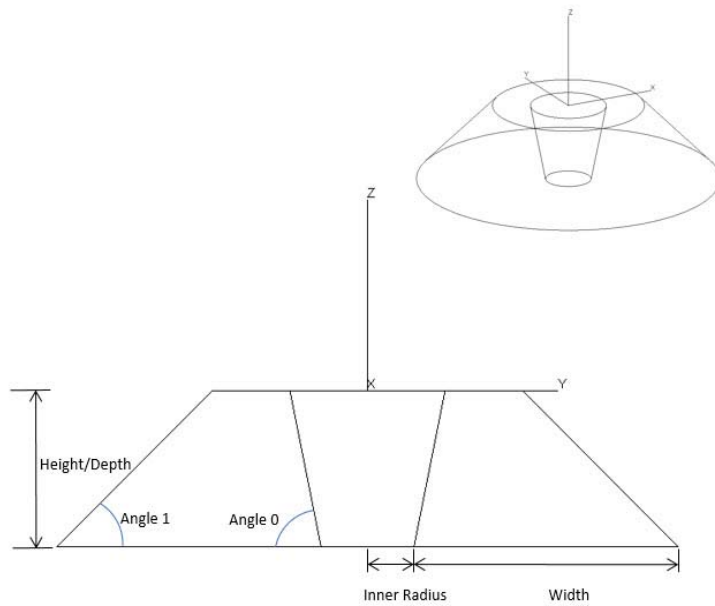

FIGURE 3.66 - Circular hip roof RepTile feature.

Cube-corner geometry

Cube corner geometry consists of cube-corner retro-reflectors arranged in a hexagonal pattern. There are no parameters needed to specify a cube-corner, other than the tile width. Cube-corners are oriented within a tile as shown in Figure 3.67. Cube-corner geometry can only be used with hexagonal tiles. Due to its shape, the perimeter edges of a cube-corner tile are not at a constant height, but the perimeter edges will mate well with neighboring cube-corner tiles.

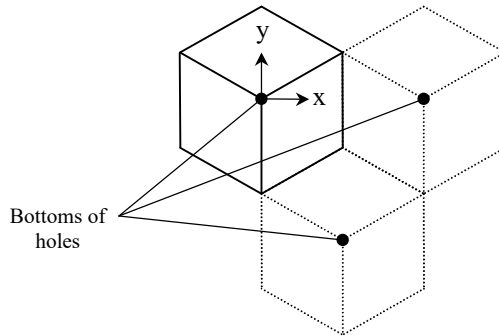

FIGURE 3.67 - A cube corner is oriented in a hexagonal tile as shown (along with two neighboring tiles). The cube corner tile is always concave, that is, the vertex (at the origin in this illustration) is at the bottom of a hole.

Pyramid geometry

Pyramid geometry consists of a regular pyramid, with point facing up for bump geometry or down for hole geometry. The inputs for a Pyramid are the radius of a circle circumscribing the pyramid, pyramid angle and number of sides. The pyramid angle is the angle between a side plane of the pyramid and the base plane. For parameterized geometry, you can also enter decenter in x and y.

Circular hip roof geometry

Circular hip roof RepTile geometry is a solid circular hip roof specified by inner radius, height/depth, width, and angles. Parameterized circular hip roof can also be decentered in x and y.

Texture File

Texture Files are a method to apply RepTile-type Geometry to surfaces. These Texture Files contain numerical data about the Features that comprise the RepTile Geometry; however, there are a number of differences between RepTile Texture File and standard RepTile Geometry:

- The data describing the Features comes from an external file that is generated by other means (e.g., CAD or spreadsheet programs).
- The Texture File must follow a prescribed data format (See “Texture File Format” on page 7.111.).
- Each Feature within the Texture File is distinct, meaning that the Features are not tiled across the selected RepTile region, but each must be specifically listed in the TextureFile (thus this file can get quite large).
- The Feature data does not have to be in any particular order, such that Feature spatial positions, size, and so forth can be variable (i.e., random) within the file.

- Multiple Features can inhabit the same RepTile Tile/Pixel.
- If features overlap, unpredictable results may occur, resulting in raytrace errors. This is not recommended.
- A Texture File can contain both Bumps and Holes, but the user must practice caution with this option since overlap of Features can lead to non-physical RepTile Geometry (i.e., undercut). A protocol is followed within TracePro to disallow such (“Base Plane Designation for Textured RepTile” on page 4.52).
- The ability to invert the Bump/Hole designation of each Feature with the use of the Bump/Hole Button in the RepTile Property Editor.
- The RepTile Buffers are 1×10^{-10} mm.
- Texture File Features overlapping the RepTile boundary are ignored.

Otherwise, the defining, applying, and ray tracing of RepTile Texture Files is accomplished the same way as other RepTile Properties. The current capabilities for the Feature Geometry Types that can be contained within a RepTile Texture File are shown in Table 3.13 on page 3.55.

In the RepTile Property Editor window, follow these steps to define a new RepTile Texture File:

- While in the Catalog of interest, select **Add Property...**, which will display the Enter New RepTile Property dialog (see Figure 3.68).

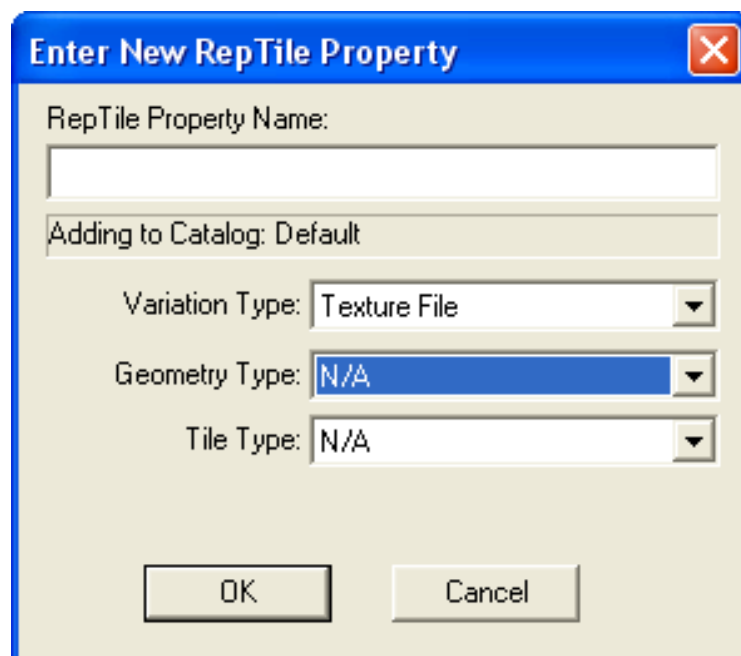

FIGURE 3.68 - Enter new RepTile property for a Variation Type of Texture File.

- Provide a RepTile Name and for Variation Type select *Texture File*. Note that Tile Type and Geometry Type are not applicable (N/A).
- Select OK, which will show return focus to the RepTile Property Editor.
- You can now enter a text Description.

- Additionally, while each Feature within the Texture File has a Bump or Hole designation, you can invert this designation by using the Bump/Hole button. By showing Hole with this button, the direction of the Feature (i.e., Bump or Hole) will be inverted for the ray trace. You can set the default bump/hole setting to Bump, Hole, Mixed, or Inverted using the combo box (see “Bump Designation for Textured RepTile” on page 4.48 for more details on each type).
- The RepTile Type area of the RepTile Property Editor shows Variation Type: *Texture File*, Tile Type: *N/A*, and Variation Type: *N/A*.
- Within the Tile Parameters area of the RepTile Property Editor allows only one entry at this time, File along with a Browse (i.e., "...") button to locate the file. Enter the Filename including path or use the Browse button to locate it. The updated RepTile Property Editor appears as shown in Figure 3.69 on page 3.77.
- Once you have selected the File, the *Def. Width* and *Def. Height* data entry cells are opened for editing. These are the default tile widths and heights respectively. The initial values are 0, but it is good practice to enter positive spatial dimensions for each. Note that you have the ability to enter model specific values for the Tile width and height (see “Specifying a RepTile Texture File Surface” on page 4.46).

Upon completing the steps listed above, your RepTile Texture File property is complete. There is no additional data that needs to be entered to specify your RepTile Texture File property. Select the Save the Property icon to save the newly created property in the database.

For creation of a Texture File, please See “Texture File Format” on page 7.111 for further discussion on this topic.

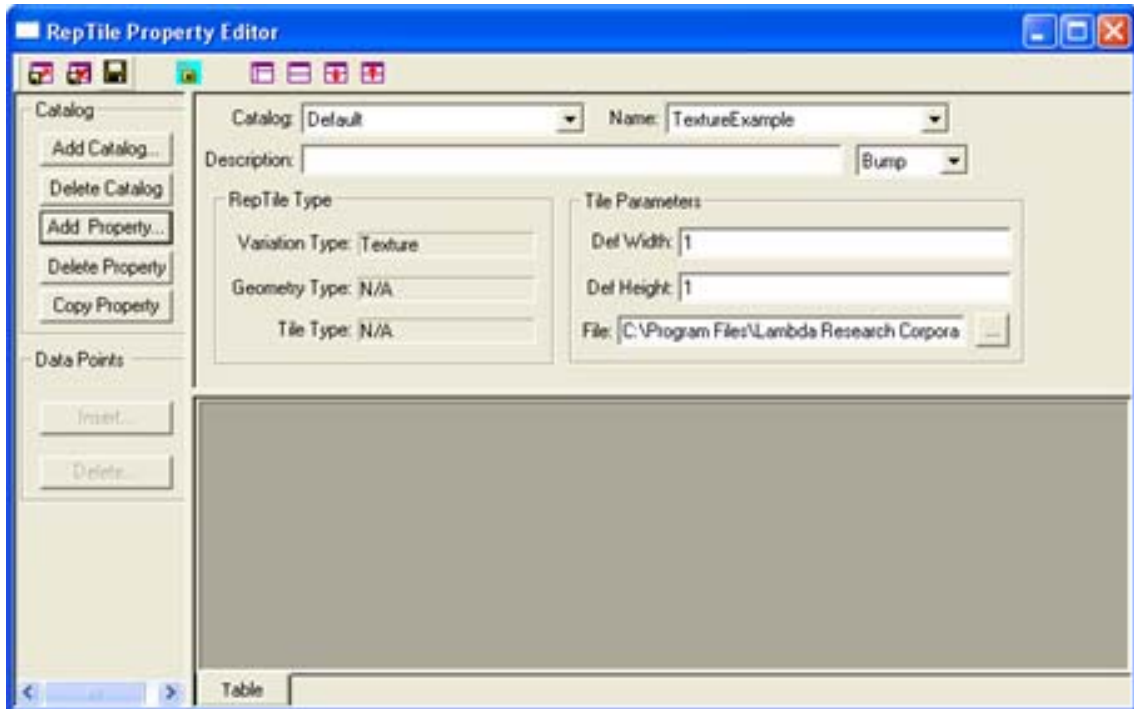

FIGURE 3.69 - RepTile Property Editor for the input of a Texture File after the File has been entered or selected and the default width and height have been set.

RepTile Parameterization

RepTile Geometry and Tile patterns can be parameterized (defined by a mathematical expression). To access this capability, select the Variation Type to be "Parameterized" when creating a new RepTile Property

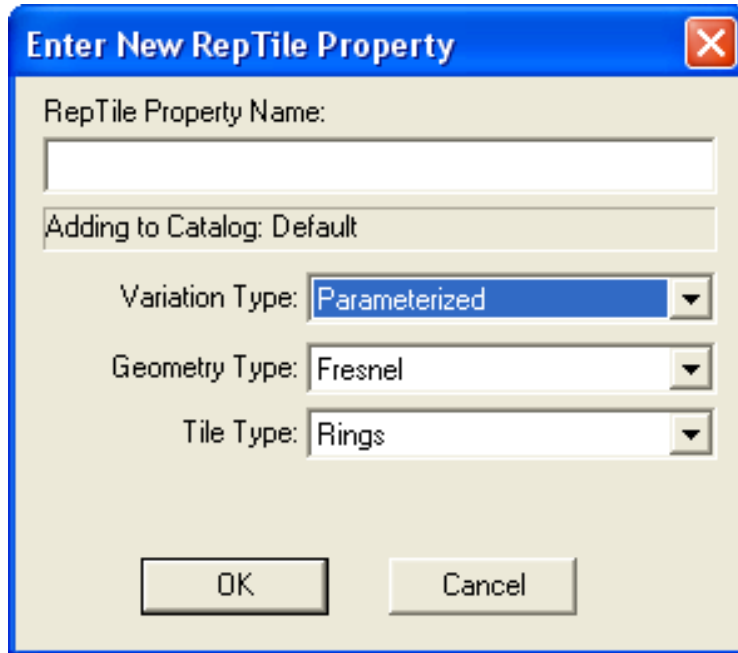

FIGURE 3.70 - New RepTile Property dialog.

Variables

To add parametrization, variables have been defined based on the types of tile selected for the property. The variables are used to identify a tile's position within the RepTile geometry. By defining a RepTile parameterization, the tile and geometry can vary over the surface upon which the property is applied. The variables provide in the mathematical expressions vary depending on the *Tile Type* as follows:

Rectangle and Staggered Rectangle

iRow = row number (counting in the +Y direction)

jCol = column number (counting in the +X direction)

Ring

iRing = ring number (counting from the center outward)

jAzi = azimuth angle (in degrees, clockwise from the +x axis)

Parameterized Input Fields

In the RepTile Property Editor, the input fields that appear in Evaluator Control color, see "Background colors" on page 2.58, are fields that will accept a mathematical expression. The expressions are the same as the one used in dialog box controls described in the section titled "Expression Evaluator" on page 1.15. The functions can use the variables defined above. The Variables allowed in these expressions are dependent on the Tile Type and Geometry Type as show in Table 3.14 and in Table 3.15.

TABLE 3.14. Tile Parameters

Tile Type	Input Field	Associated Variable Names
Ring	Ring Width	iRing
	Seg. Width	IRing, jAzi
	Start Angle	IRing
	# of Segments	iRing
Rectangles	Width	jCol
	Height	iRow
Staggered Rectangles	Width	jCol
	Height	iRow
	Row Offset	iRow

Note that the Row Offset for the Staggered Rectangles tile type is the offset between one row to another. Entering a constant value does not cause any staggering, and, thus, it appears as a Rectangle tile type. To get staggering that varies by row you must enter some functional form with the iRow variable. For example, to obtain a half-tile width stagger, you could use a formula such as:

$$\text{Row Offset} = (\text{TILE WIDTH}) * (\text{iRow} \% 2) / 2,$$

where “iRow” indicates the row number, “%2” indicates modulus 2 (i.e., the remainder if you divide iRow by 2), “/2” gives either a value of 0 or 0.5, and “TILE WIDTH” is the value that you entered for the TILE WIDTH (i.e., you must enter the explicit value). The Row Offset value is then the offset in millimeters from one row to another as per the entered equation.

TABLE 3.15. Geometry Parameters

Geometry Type	Input Field	Variables allowed
Fresnel	Facet Angle	iRing
	Draft Angle	iRing
Cone	End Radius	iRow / iRing, jCol / jAzi
	Depth/Height	iRow / iRing, jCol / jAzi
	Cone Angle	iRow / iRing, jCol / jAzi
	Chamfer Height	iRow / iRing, jCol / jAzi
	Chamfer Angle	iRow / iRing, jCol / jAzi
	Decenter (x, y)	iRow, jCol
	Decenter (r, phi)	iRing, jAzi
	Sphere	Radius
Sphere	Depth/Height	iRow / iRing, jCol / jAzi
	Decenter (x, y)	iRow, jCol
	Decenter (r, phi)	iRing, jAzi
	Ellipsoid	X Radius, Y Radius, Z Radius
Ellipsoid	Center Height	iRow / iRing, jCol / jAzi
	Rotate X, Rotate Y, Rotate Z	iRow / iRing, jCol / jAzi
	Decenter (x, y)	iRow, jCol
	Decenter (r, phi)	iRing, jAzi
	Hip (Mansard) Roof	Depth/Width
Hip (Mansard) Roof	X Width, Y Width	iRow / iRing, jCol / jAzi
	X Angle, Y Angle	iRow / iRing, jCol / jAzi
	Orient	iRow / iRing, jCol / jAzi
	Decenter (x, y)	iRow, jCol
	Decenter (r, phi)	iRing, jAzi
	Cube Corner	(none)
Prism	Y(0) Angle, Y(1) Angle	iRow / iRing, jCol / jAzi
	X(0) Angle, X(1) Angle	iRow / iRing, jCol / jAzi
Rounded Prism	Y(0) Angle, Y(1) Angle	iRow / iRing, jCol / jAzi
	Peak Radius	iRow / iRing, jCol / jAzi
	Trough Radius	iRow / iRing, jCol / jAzi
Enhanced Prism	Xwidth, Ywidth, Depth/Hgt	iRow / iRing, jCol / jAzi
	X0, X1, Y0, Y1 angles	iRow / iRing, jCol / jAzi
	Peak 0,1, Trough 0,1 radii	iRow / iRing, jCol / jAzi

Enhanced Prism	Orientation	iRow / iRing, jCol / jAzi
	Decenter (x, y)	iRow, jCol
	Decenter (r, phi)	iRing, jAzi
Log	Center Depth/Height	iRow / iRing, jCol / jAzi
	Length	iRow / iRing, jCol / jAzi
	End radii	iRow / iRing, jCol / jAzi
	X, Y, Z rotation	iRow / iRing, jCol / jAzi
	Radius Ratio	iRow / iRing, jCol / jAzi
	Decenter (x,y)	iRow, jCol
	Decenter (r, phi)	iRing, jAzi
Flattened Cone	End Radius	iRow / iRing, jCol / jAzi
	Depth/Height	iRow / iRing, jCol / jAzi
	Cone Angle	iRow / iRing, jCol / jAzi
	Peak Radius	iRow / iRing, jCol / jAzi
	Trough Radius	iRow / iRing, jCol / jAzi
	Decenter (x, y)	iRow, jCol
	Decenter (r, phi)	iRing, jAzi
Pointed cone	Depth/Height	iRow / iRing, jCol / jAzi
	Cone Angle	iRow / iRing, jCol / jAzi
	Peak Radius	iRow / iRing, jCol / jAzi
	Trough Radius	iRow / iRing, jCol / jAzi
	Decenter (x, y)	iRow, jCol
	Decenter (r, phi)	iRing, jAzi
Block	Center Depth/Height	iRow / iRing, jCol / jAzi
	X Width	iRow / iRing, jCol / jAzi
	Y Width	iRow / iRing, jCol / jAzi
	Z Width	iRow / iRing, jCol / jAzi
	Rotate X	iRow / iRing, jCol / jAzi
	Rotate Y	iRow / iRing, jCol / jAzi
	Rotate Z	iRow / iRing, jCol / jAzi
	Decenter (x, y)	iRow, jCol
	Decenter (r, phi)	iRing, jAzi
Polygon	Radius	iRow / iRing, jCol / jAzi
	Depth/Height	iRow / iRing, jCol / jAzi
	Thickness	iRow / iRing, jCol / jAzi
	No. of Sides	iRow / iRing, jCol / jAzi
	Rotate X	iRow / iRing, jCol / jAzi

	Rotate Y	iRow / iRing, jCol / jAzi
	Rotate Z	iRow / iRing, jCol / jAzi
	Decenter (x, y)	iRow, jCol
	Decenter (r, phi)	iRing, jAzi
Pyramid	Radius	iRow / iRing, jCol / jAzi
	Angle	iRow / iRing, jCol / jAzi
	No. of Sides	iRow / iRing, jCol / jAzi
	Decenter (x,y)	iRow, jCol
	Decenter (r,phi)	iRing, jAzi

Parameter Expressions

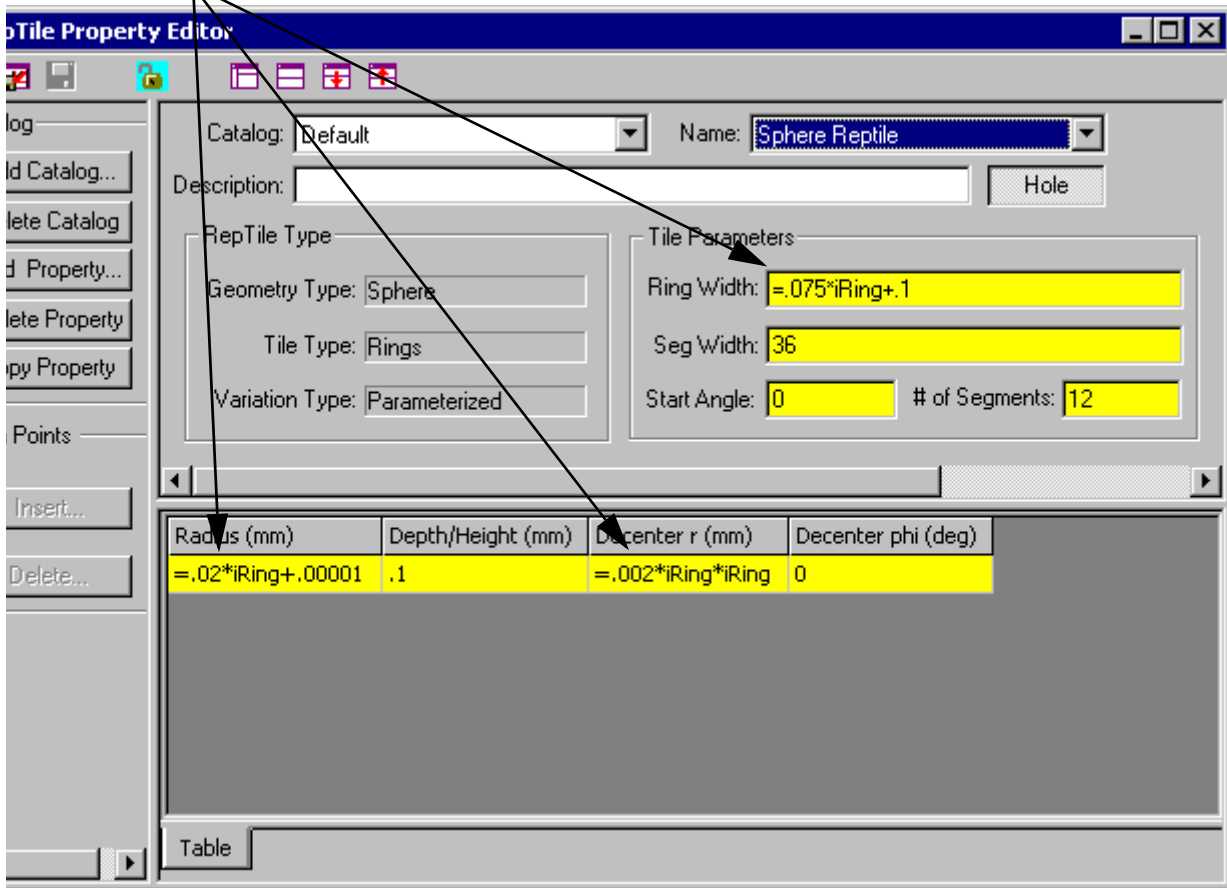

FIGURE 3.71 - Sphere Geometry Expressions using the iRing Variable.

Decentering RepTile Geometry

The cone, sphere, ellipsoid, hip (Mansard) roof, enhanced prism, and log geometry provide a decenter parameter if the Variation Type Parameterized is specified for the property. In this case the geometry can be decentered within the tile. For the rectangle and staggered rectangle tile types, the input parameters are

Decenter x and Decenter y. For ring tiles, the input parameters are Decenter r (positive r is outward) and Decenter phi, where phi is in degrees and 0 phi is in the +X direction. See Figure 3.71 for an example of a ring tile property with sphere geometry.

Property Database Tools

The **Tools|Database** menu provides tools to update and maintain the TracePro properties database. The Property data is stored in a database file named TracePro.db by default. You can set the actual name and location of the property database in the **View|Options|General** dialog box.

You can also update the database from the Lambda Research website from a selection on the **Help** menu, as described below.

Update Property Database

TracePro is published with many “built-in” properties to aid you in building accurate models. From time to time Lambda Research updates this built-in database with new or improved properties. To download and install the most recent property database from the Customer Support Center at www.lambdare.com, select **Help|Update Property Database**. Updating your database will **not** overwrite or delete any properties you have created and added to your database.

Import

The **Tools|Database Import** selection translates property data into TracePro from a text file. Unlike the Import Property commands associated with the various editors, the text file can contain several properties, of the same or different types, separated by a “SAVE-DATA” line. Thus, surface properties, material properties, bulk scatter properties, etc. can all be concatenated into a single file, each property separated by a “SAVE-DATA” line. All data from the default property database is included on the TracePro distribution media.

Note: SAVE-DATA is used to define the last line of a property for a concatenated property file. If you are reading the file or creating a property file for TracePro import see the section titled “Property Import/Export Formats” on page 7.93.

During importation, the property names are checked against the current properties in the database. If a name matches an existing property, you are notified. The individual property can be overwritten or skipped. If you are importing many properties you have the option to overwrite the current entry, all subsequent entries, to skip the current entry or to skip all subsequent entries as shown in Figure 3.72.

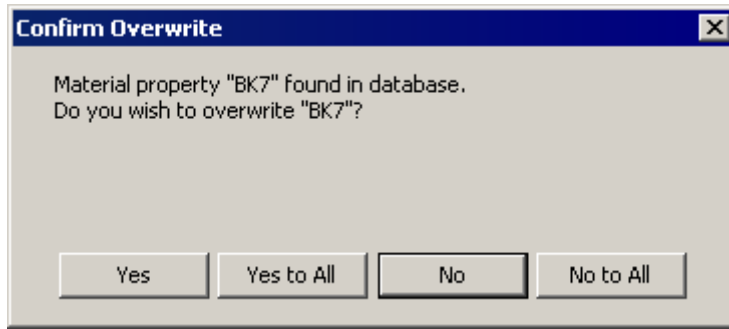

FIGURE 3.72 - Confirm Overwrite dialog.

Export

The Property Export command will generate a single file containing all property data for a Model. Selecting **Tools | Database | Export** or pressing the F12 key will generate a text file of property data. The *File Save As* dialog will be displayed to allow you to enter a property file name. Each property is separated by a SAVE-DATA line as described in the online help. The data may be reentered using **Tools | Database | Import** or the F11 key.

If you are working with TracePro support personnel or are collaborating with other TracePro users and are sending oml files, you should export the model properties and send the property file along with the oml file. These two files contain all the data required to open and analyze a TracePro model.

Using Properties

After the geometry has been created in TracePro, properties are assigned to the geometry to determine how rays interact with the model and how it is displayed in the Model Window. TracePro allows you to define your own properties (see Chapter 3, “Defining Properties”).

Limitations in Pre-Defined Property Data

Much of the property data supplied with TracePro is derived from data sheets and published data. In some cases the data is very complete as is the case with optical glass data from manufacturers like Schott, Ohara and Hoya. In other cases the data is only given for a small range of values, which is the case for the metal properties from manufacturers like Alanod and Sacall. For example aluminium suppliers declare specular reflection and diffuse reflection in accordance with DIN 5036, a method of measurement which use an integrating sphere. This is insufficient to describe the BSDF distribution function necessary to simulate scatter in TracePro. It is recommended that each user verify that the data is appropriate for their needs and that measured data be obtained directly from the material vendor or a third party measurement service. This is particularly important for scatter data and optical coatings.

Applying Property Data

What properties are needed to model a specific problem? To answer this question, it is useful to think of the properties in terms of Physical Properties vs. Raytrace Properties.

Physical Properties translate into the hardware that is built when the model or design is completed. These properties have a direct impact on the ray trace and include Material and Surface properties. The list of Physical Properties in Table 4.1 can be reviewed to determine which properties are applicable to a given model.

Raytrace Properties are applied to utilize features available in TracePro to assist you in making the ray trace more efficient. These properties are not physical attributes of the final hardware. Importance Sampling and Exit Surface are examples of ray trace properties. It is not necessary to apply any of these properties to a given model. Once the Physical Properties have been applied, you can move ahead to Chapter 5, “Ray Tracing and Optimization” to determine which TracePro Raytrace features will be useful for the model, and then come back to this chapter to apply the necessary ray trace properties.

The method for applying properties is the same for all properties. The only distinction is between properties that are applied to Objects vs. those applied to Surfaces. See Table 4.1 for a summary. The steps for adding properties are:



- Select **Defi ne|Appl y Propert i es** from the menu to open the Apply Properties dialog box. A right click in either the System Tree or the Model Window

provides a shortcut to the Properties dialog box. See “Context Sensitive Menus” on page 1.9.

- Select the appropriate tab within the Apply Properties box for the property to be updated.
- Select the object or surface, either by selecting it in the System Tree or in the Model Window. See “Selecting Objects and Surfaces” on page 1.11.
- Input the necessary data into the Apply Properties dialog (see the remainder of this chapter for specific information about each property)
- Click the *Apply* button.
- To confirm that a property has been applied, expand the object or surface in the System Tree and review the property information.
- The Apply Properties dialog is a modeless dialog, so it can be left open while doing other tasks in TracePro. At any time, you can come back to the open Apply Properties dialog, select an Object or Surface in the System Tree, input the necessary data and click *Apply*.
- Surface Properties may be applied to individual surfaces or to objects. If the property is being applied to a selected object, each of the object’s surfaces will receive the property data. This useful shortcut is provided for your convenience. Be careful to select the desired set of objects and surfaces when applying property data.

TABLE 4.1. Apply Properties Categories

	Object	Surface
Physical Properties	Material* Temperature Mueller Matrix* (polarization) Gradient Index* Bulk Scattering*	Surface* Surface Source* Diffraction Temperature Temperature Distribution RepTile**
Raytrace Properties	Raytrace Flag Importance Sampling	Surface Source Prescription Importance Sampling Exit Surface
Other Properties	Color Class and User Data	Color

* Properties must exist in the Property Database to be used. A number of properties are predefined for your use, but you may define new ones (See Chapter 3).

Expert

** RepTile Properties must be defined prior to use and are stored in the Property Database (See “RepTile Surfaces” on page 3.49.).

To provide additional perspective on the Apply Properties tools discussed in this chapter, Table 4.2 lists the properties and the purposes for which they are used.

TABLE 4.2. Properties and Applications

Properties	When Needed?
Material	Refraction, Fresnel Reflections, Bulk Absorption, Bulk Scattering, Gradient Index
Surface	Reflection (other than Fresnel reflection), Coatings, Thin Film Stacks, Scatter, Surface Absorption, Gratings
Surface Source	Used to define source for Surface Ray Tracing. See Chapter 5, "Ray Tracing and Optimization".
Temperature	Needed only if other properties are temperature-dependent, such as cases where the Index of Refraction varies with temperature
Mueller Matrix	Needed only when modeling Polarization effects
Gradient Index	Needed only for materials with varying Indexes of Refraction, requires Material property
Bulk Scattering	Needed only for modeling scatter from within the volume of an object, requires Material property (For Surface Scatter, see "Surface Properties" on page 4.10)
Fluorescence	Used to simulate models with fluorescent material.
Diffraction	Needed only when the diffraction effects of rays incident near the edges of an aperture are significant, usually for stray light analysis
Color	To change the display color of an object or surface to another color from the default color (green)
Class & User Data	Provides resources that the macro language can use
Raytrace Flag	Lets you remove individual objects from a raytrace
Prescription	Needed for Auto Importance Sampling and optical scatter intercept limits
Importance Sampling	Needed only for Importance Sampling
Exit Surface	Needed for Simulation Mode raytraces and Reverse Ray Tracing
RepTile	Needed for modeling surfaces with repeated structures
Temperature Distribution	Used to apply spatially varying temperature distributions to surfaces, requires Surface property

Material Properties

Use the Material Property to specify the index of refraction and the bulk absorption of an object.

The screenshot shows a dialog box titled "Apply Properties Dialog Box - Material". At the top, there are two dropdown menus: "Catalog" set to "SCHOTT" and "Name" set to "<None>". Below these is a section titled "Display of index and absorptance for given wavelength" containing several input fields: "Wavelength" (0.5461 μm), "Index" (1), "Absorption Coef" (0), and "Transmission" (0 through 10 mm). A note below these fields states: "The wavelengths used during the Raytrace are taken from each source definition". At the bottom of the dialog, there is a section "Current Material on selected Object" with a text area containing the message: "If <None> is displayed: Check the TracePro Database For the catalog and name." Two buttons, "Apply" and "View Data", are located at the bottom right of the dialog.

FIGURE 4.1 - Apply Properties Dialog Box - Material

The Material tab displays a series of buttons and dropdown boxes that allow you to:

- Select an existing material property from the Property Database.
- View the data for the selected property
- Apply the selected property to an object in the model.

Material Catalogs

The Material Properties are grouped into Catalogs. You can add more catalogs to make it easier to find properties that you want to apply.

The catalogs include manufacturer's data, other data supplied with TracePro, and user-defined materials.

Applying Material Properties

A database exists containing predefined materials. You can choose among them or you can modify or add user-defined materials by using the Material Property editor. See "Material Properties" on page 3.5.

To apply material properties to an object in your model:

1. Select an object in your model. You can select an object by clicking it in the System Tree or in the model window.
2. Choose **Define|Apply Properties** and select the Material tab.
3. Select a catalog using the drop-down catalog list and select the name of the desired material using the drop-down name list.
4. Click *Apply* to apply the changes.
5. Check to be sure that the new property is visible in the system tree.

Applying Birefringent Material Properties Expert

To apply birefringent material properties to an object in your model:

1. Select an object in your model. You can select an object by clicking it in the System Tree or in the model window.
2. Choose **Define|Apply Properties** and select the Material tab.
3. Select a catalog using the Catalog list and select the name of the desired material using the Name list.
4. For birefringent properties, you must also enter the Crystal Axis. In the Birefringent Crystal Axis box, enter a vector parallel to the crystal axis. The orientation of the crystal axis will be maintained relative to the object as the object is moved and rotated. See Figure 4.2.
5. Click *Apply* to apply the changes.
6. Check to be sure that the new property is visible in the system tree.

Catalog: Birefringent (Yeh)

Name: Calcite, CaCO₃

Display of index and absorptance for given wavelength

Wavelength: 0.5461 μm Ordinary Data

Index: 1.658 Absorption Coef: 0

Transmission 1 through 10 mm

The wavelengths used during the Raytrace are taken from each source definition

Birefringent Crystal Axis

X: 1 Y: 0 Z: 0

Current Material on selected Object

If <None> is displayed: Check the TracePro Database For the catalog and name.

Apply View Data

FIGURE 4.2 - Material data for a Birefringent material

Bulk Scattering Standard Expert

Bulk scatter is scatter caused by particles and inclusions within a material. A bulk scattering property works together with an object's material property. (See the Technical Reference page 7.61 for more details).

FIGURE 4.3 - Apply Properties Dialog Box - Bulk Scattering

Bulk Scatter properties are applied by selecting **Define | Apply Properties | Bulk Scattering** as shown in Figure 4.3 and edited by selecting **Define | Edit Property Data | Bulk Scatter Properties**. A simple example, shown in Figure 4.4 on the left, uses a block of Schott BK7, 1 mm on each side. A single ray, shown in red, is incident at 45 degrees on the front of the block. It is then reflected via total internal reflection from one side, and finally refracts through the back surface. The blue rays denote rays resulting from Fresnel reflections.

The plot shown on the right shows the same model except a Bulk Scattering property has been added.

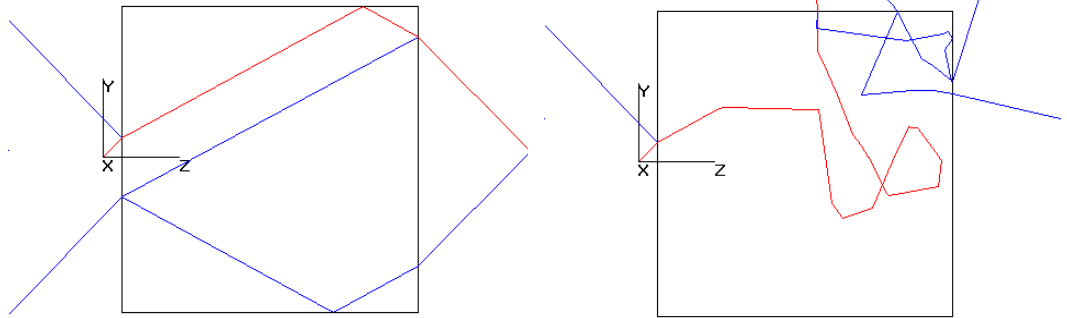

FIGURE 4.4 - Block of glass shown before (left) and after (right) Bulk Scattering property is applied.

You can also apply importance sampling to a solid object to enhance the sampling of bulk scatter. To obtain Figure 4.5, an importance target at the base of the object increases the number of rays propagating toward the target. Each importance ray is scattered within the object.

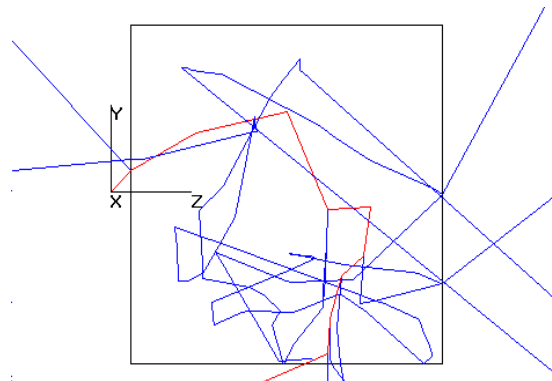

FIGURE 4.5 - Bulk Scattering with Importance Sampling Target

Note: The flux threshold for these examples was set to 0.0005. See “Thresholds” on page 5.46.

To use bulk scattering:

1. Apply a material property appropriate for the volume within which the scattering is to be modeled.
2. Apply a Bulk Scattering property.

Fluorescence Properties Expert

Fluorescence is modeled in TracePro through a combination of fluorescence properties applied to objects and enhanced ray tracing features. Fluorescence Properties include relative absorption and relative excitation normalized to the peak molar extinction coefficient, and relative emission. Concentration of the fluorescing material can be set in the model by entering the molar concentration

when applying the property to a solid object. When the model is raytraced, the raytrace is broken into two stages. In the first stage of the raytrace, rays are traced in the excitation part of the material spectrum. A by-product of the first stage of the raytrace is that TracePro ray files are generated which contain rays emanating from sites in the fluorescent material. The second stage of the ray trace uses the ray files to trace fluorescent rays.

Catalog: Clontech_Proteins
Name: Living Color™ AmCyan
Description: "data from Clontech Laboratories, Inc."
Conversion Efficiency: 0.75
Peak Molar Extinction: 39000 liter/(mole*cm)
Molar Concentration: 1e-9 moles/liter
Wavelength: .6 Add Delete

From (μm)	To (μm)	# Inc.	Calc. Wavelength
0	0.46	0	0.23
0.46	0.6	3	0.483333
			0.53
			0.576667

Apply View Data

FIGURE 4.6 - Fluorescence Property data.

Applying Fluorescence Properties

Database catalogs exist that contain predefined fluorescent properties. You can choose among them or you can modify or add user-defined materials by using the Fluorescence Property editor. See "Fluorescence Properties" on page 3.12.

To apply Fluorescence properties to an object in your model:

1. Select an object in your model. You can select an object by clicking it in the System Tree or in the model window.
2. Choose **Define|Apply Properties** and select the Fluorescence tab.
3. Select a catalog using the drop-down catalog list and select the name of the desired material using the drop-down name list.
4. Edit the Conversion Efficiency and Peak Molar Extinction values, if required
5. Enter the Molar Concentration.
6. Add Fluorescence emission waveband edges and enter the number of wavelengths (# Inc) within each band. Emission rays will be generated at each

wavelength. You can easily exclude the zero-to-first-wavelength band and last-wavelength-to-infinity band by entering 0 for the # Inc value.

7. Click *Apply* to apply the changes.
8. Check to be sure that the new property is clearly visible in the system tree.

Fluorescent properties are used in combination with the object's bulk material properties. The Refractive Index and Absorption will be determined by the Material Property applied to the object. See "Applying Material Properties" on page 4.4.

Gradient Index Properties Standard Expert

Gradient Index Properties apply to materials with an inhomogeneous index of refraction. Examples are glass in which the index changes from center to edge, or optical fiber that also refracts light differently from center to edge.

The gradient index is coupled to the object's material property to vary the index of refraction along a parametric profile.

Note: GRADIUM, one of the types in the Type dropdown box, must be treated differently. Unlike others, the GRADIUM Gradient Index includes material property data and does not require association with a material property. In cases like this one, Do NOT apply a material property to an object that has GRADIUM applied.

For all other Gradient Index properties, you must apply a material property to supply the base index of refraction. For example, an Axial-Radial profile as shown in Figure 4.7 can be defined by doing the following:

Select **Define | Apply Properties | Material** tab and apply a glass material to the rod (e.g. Schott BK7).

Select **Define | Apply Properties | Gradient Index** property tab to apply the property. The profile is applied to the glass rod object along with an origin and propagation direction. An Up Vector is included to define lateral symmetries. Once this data is applied, the origin and direction vectors are updated if you move or rotate the object.

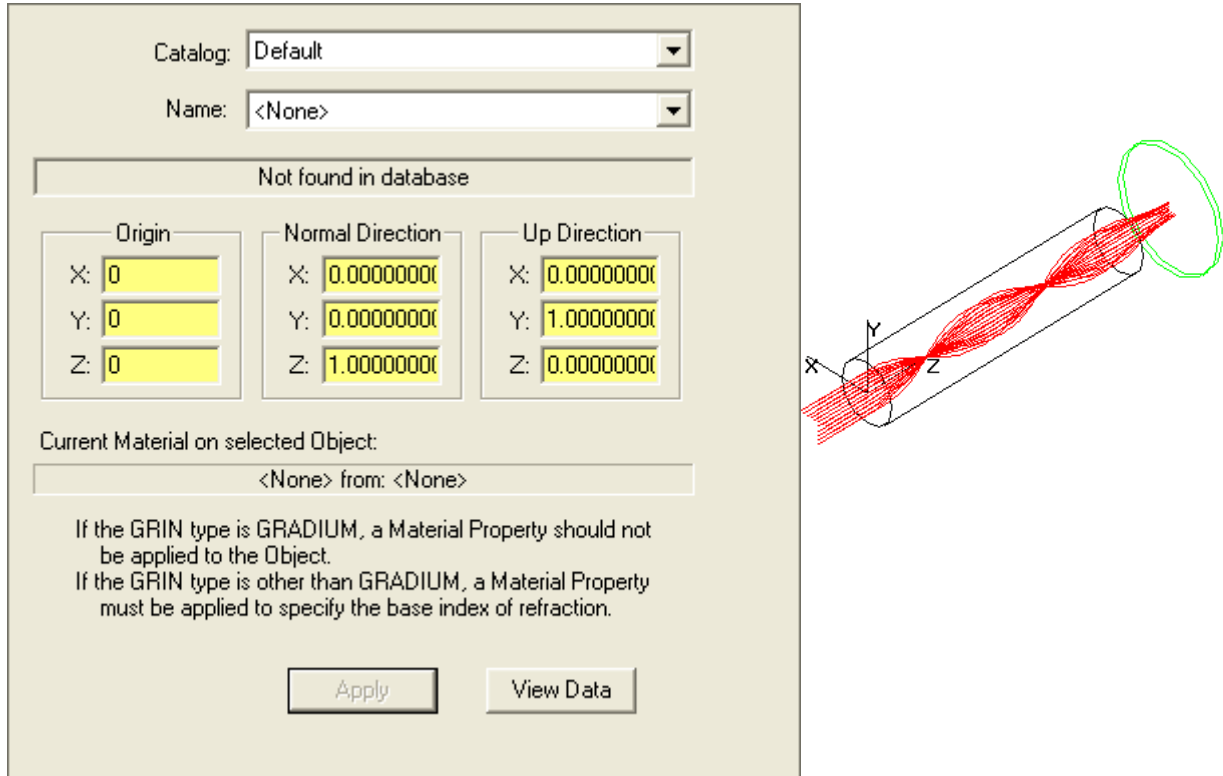

FIGURE 4.7 - Applying a GRIN Property to a Rod

Surface Properties

Surface properties provide physical data for absorptance, scatter (BRDF and BTDF), specular reflectance and specular transmittance. In TracePro, surface properties are identified by name and catalog, and stored in a database.

For detailed descriptions of the components of surface properties such as BRDF and BTDF, see Chapter 7, “Technical Reference”.

To select a property and apply it to a surface, use the following steps:

1. Select a surface in your model. Select from the model window or from the System Tree. You may also select an object to apply the property to all the surfaces of the object.
2. Select **Define | Apply Properties** and then select the Surface tab.
3. Select a surface property catalog and name from the drop-down lists.
4. For a Table Type Surface Property, a “Reference Data” tab is displayed. You also need to select “Angles Measured in Air” or “Angles Measured in Substrate”. The “Angles Measured in Substrate” option is required only if the raw data used to create the surface property was measured in a medium other than air. For all other cases, the default selection of “Angles Measured in Air” must be used.
5. For a Grating Type Surface Property, you also need to input the values for the Up Direction. The Up Direction is the direction of positive grating orders, and

also specifies the zero azimuth direction for anisotropy and asymmetric scatter.

6. For Anisotropic properties or Elliptical BSDF, you need to define the Anisotropic/Asymmetric Axis which orients the 0.0 angle for the Azimuth direction.
7. For Asymmetric Table BSDF, you can choose “Use fixed axis for zero-azimuth asymmetric scatter” allowing you to define the Anisotropic/Asymmetric Axis which orients the 0.0 angle for the Azimuth direction.
8. Click the *Apply* button.
9. Check the System Tree for the changes you entered.

Note that for neighboring objects, you have the issue of coincident surfaces and the problem of how TracePro handles the situation if different surface properties are applied to these two distinct surfaces. See “Coincident Surfaces” on page 7.15.

The screenshot shows a dialog box for defining surface properties. At the top, there are two dropdown menus: 'Catalog' (set to 'Anisotropic') and 'Name' (set to 'EllipticalGaussianAnisotropic'). Below these is a 'Description' field (empty) and a 'Scatter' dropdown (set to 'Elliptical Gaussian Scatter'). A checkbox labeled 'Use fixed axis for zero-azimuth for asymmetric scatter' is checked. The dialog has two tabs: 'Reference Data' and 'Anisotropic Axis', both of which are active. Under the 'Anisotropic Axis' tab, there is a section titled 'Orientation vector for Anisotropic Properties and Asymmetric Scatter' containing a sub-section 'Zero Azimuth Direction' with three input fields: 'X:' (0), 'Y:' (1), and 'Z:' (0). At the bottom of the dialog are two buttons: 'Apply' and 'View Data'.

FIGURE 4.8 - Surface property with Reference Data and Anisotropic/Asymmetric Axis tabs

Using the Surface Property Database

A database filled with predefined surface properties exists as a resource in TracePro. You can view current surface property definitions, add your own catalogs and add your own surface properties using the Surface Property editor (See “Surface Properties” on page 3.23.).

Surface Source Properties

A surface source is a surface that is designated to emit rays in a raytrace. There are five types of surface source properties in TracePro. Two types can emit discrete wavelengths (flux, irradiance) and two types can emit calculated wavelengths (blackbody, graybody). The fifth type, Surface Source Property, can emit either discrete wavelengths or calculated wavelengths.

You can make any surface in a TracePro model a source of rays for use in a raytrace:

1. Select a surface to which to apply a surface source property. You can make a surface selection in the System Tree or in the model window.

Note: If you apply a surface source to an object, TracePro will apply the property to each of the object's surfaces.

2. Choose **Define|Apply Properties** to open the Apply Properties dialog box. You can also access the dialog from the Source tab in the System Tree or from the **Define|Surface Source** menu.
3. Select Surface Source.
4. Specify the Surface Source property type. The option that you select changes the fields on the Surface Source tab. Select from the following:
 - Surface Source Property (Figure 4.9),
 - Flux (Figure 4.11),
 - Irradiance (Figure 4.11),
 - Blackbody (Figure 4.10), or
 - Graybody (Figure 4.10).
5. Select the Units (Flux or Irradiance source only).
6. Select an angular distribution (except for Surface Source Property type).
7. Select the Rays to be emitted. In most cases this is set to All.
8. Enter a value for the flux (Flux source) or irradiance (Irradiance source) or temperature (Blackbody or Graybody source).
9. Enter the minimum number of rays for any wavelength.
10. Enter the total number of rays to trace.
11. Enter the Scale factor (only for Surface Source Properties). Use this if you need to scale the flux emitted from a Surface Source Property.
12. Enter the Up Vector (only for asymmetric Surface Source Properties, i.e. Gaussian or Table angular type). The Up Vector defines the direction of the azimuth = 0 axis of the property.
13. For a Surface Source Property Surface, select Discrete wavelengths or Calculated wavelengths.
14. Enter as many wavelengths as you need: type in each wavelength in μm , then click the Add button in the Wavelengths box or press the Enter key.
15. For discrete wavelengths, edit weights as needed.
16. For calculated wavelengths, edit #Inc as needed for each waveband.
17. Define as many surfaces to be source surfaces as you need.
 - a. Make a surface a source by first selecting **Define|Apply Properties**, or by clicking the right mouse button in the Model window and selecting **Properties...** from the pop-up menu. That menu opens the Apply Prop-

erties dialog box. See Figure 4.10 for a view of the Apply Properties dialog box.

- b. Select the Surface Source tab and select a surface.
- c. Fill in necessary fields to specify the source, and press the Apply button.

Flux and Irradiance Type Surface Sources emit discrete wavelengths, and Blackbody and Graybody Type Surface Sources emit calculated wavelengths. With a Surface Source Property surface source you can choose whether you want calculated or discrete wavelengths.

Also, you can remove the source property from a surface by opening the dialog box, selecting the surface with the mouse, then select Source Type <None> and click the *Apply* button.

Wavelengths

Wavelength (µm)	Weight	Flux	# Rays
0.5	1	1	1000
Totals		1	1000

FIGURE 4.9 - Surface Source Property Surface Source (shown with Discrete Wavelengths)

Emission Type: Min Rays:

Units: Total Rays:

Angular dist.:

Rays: Color:

Temperature:

Wavelengths

Type:

From (μm)	To (μm)	# Inc.	Calc. Wavelength	Flux
0	3	1	2.80289	0.000399675
3	5	3	3.4299	0.00378528
			4.06261	0.0156392
			4.70793	0.0391928

FIGURE 4.10 - Blackbody Source (requires Calculated Wavelengths)

Emission Type: Flux Min Rays: 10
 Units: Photometric Total Rays: 1000
 Angular dist.: Lambertian
 Rays: All rays Color:
 Flux: 100 lumens

Wavelengths

Type: Discrete wavelengths .55 Add Delete

Wavelength (μm)	Weight	Flux	# Rays
0.45	0.5	25	250
0.5	1	50	500
0.55	0.5	25	250
Totals		100	1000

Apply View Data

FIGURE 4.11 - Flux Source (requires Discrete Wavelengths)

Source Type	<p>Source Property - Uses a Surface Source Property to determine the spectral distribution, units, and total flux or irradiance to be emitted by the surface source. Uses either discrete wavelengths (see Flux or Irradiance below) or calculated wavelengths (see Blackbody or Graybody below).</p> <p>Flux—The total power emitted by a surface. Flux sources distribute the power uniformly over the surface area. The rays are emitted from the surface at random positions. Flux sources emit rays in discrete wavelengths. A portion of the total flux is allocated to each wavelength according to the wavelength weight. The number of rays for each wavelength is calculated to give each starting ray approximately the same flux, regardless of wavelength.</p> <p>Irradiance—Irradiance sources emit a specified flux per unit area. Thus, a larger total area provides a higher total flux. They use discrete wavelengths. A portion of the total flux is allocated to each wavelength according to the wavelength weight. The number of rays for each wavelength is calculated to give each starting ray approximately the same flux, regardless of wavelength.</p> <p>Blackbody—Blackbody sources require a temperature value and calculated wavelengths to calculate irradiance emitted by the source surface. TracePro uses wavebands to approximate a continuous spectrum. It calculates a spectrally-weighted wavelength to represent each waveband. In the calculation, TracePro distributes the number of rays per waveband to generate rays with approximately equal flux. The Min Rays field specifies the minimum number of rays to be emitted in each waveband.</p> <p>Graybody—Graybody sources require a temperature, an emissivity value, and continuous wavebands to calculate irradiance on a source surface. TracePro uses wavebands to represent a continuous spectrum. It calculates a spectrally-weighted wavelength to represent each waveband. In the calculation, TracePro distributes the number of rays per waveband to generate rays with approximately equal flux. A graybody calculation uses the value in the Emissivity field for determining power distribution over the surface. The Min Rays field specifies a minimum number of rays to be emitted in each waveband.</p>
Units	Specify the type of units, either Radiometric or Photometric (Flux or Irradiance sources only).
Min Rays	Specify the minimum number of rays assigned (by TracePro calculation) to each wavelength.
Total Rays	Request a number of rays to emit from a surface source. For a Flux or Irradiance (discrete wavelength) raytrace, exactly the requested number of rays will be traced. For a Blackbody or Graybody (continuous wavebands) raytrace, TracePro will calculate the number of rays based on the values entered, with the requested number as the goal. The actual number of rays to be traced is displayed in the Wavelengths grid.
Emissivity	For a graybody specify a number from zero to 1 to indicate the emissivity. The number is used in the calculation of flux emitted by the surface.
Apply Button	Apply the new values in the dialog box to the surface source.
Totals	The actual count of rays and flux to be emitted by the surface source, shown in spreadsheet area of the dialog box.

View Data Button	When a Source Property type surface source is selected, you can open the Surface Source Property Editor to view the property data by clicking the View Data button.
Color	You can change the color of the rays as they are displayed in the model window. To make this work you must also change the selection in <i>Analysis/Ray Colors</i> ; choose <i>Source-based ray colors</i> to have rays displayed in the source color.
Angular Distribution	Select Lambertian, Normal to Surface, Surface Absorptance, or Uniform. Surface Sources emit light in one of the four angular distributions. Specifying angles and probabilities for the rays is important for the accuracy of the ray-trace. Lambertian — Emits radiation with a cosine-weighted angular distribution. Normal to Surface — Emits radiation in a direction perpendicular to the surface. This option allows you to use a sphere to generate a diverging spherical wavefront (as from a point source) or the inside of a spherical shell to generate a converging spherical wave Surface Absorptance — Uses the absorptance vs. angle of incidence profile specified by the surface's Surface Property as an angular emissivity distribution for emitting rays. The wavelength dependence is also used as the spectral emissivity for blackbody and graybody sources. Uniform — Generates rays uniformly into a hemisphere. This allows you to use a flat surface to simulate a point source, i.e. one with a spherical symmetry.
Rays	You can select <i>All rays</i> , <i>Only random rays</i> , or <i>Only importance rays</i> . Importance sampling must be applied to the surface to have any rays emitted when <i>Only importance rays</i> is selected.
Discrete Wavelengths	Here, a wavelength refers to a single discrete wavelength. For a raytrace that uses many wavelengths, TracePro lets you optionally specify a mathematical weight for each wavelength to enhance or diminish the role of the wavelength in calculations.
Calculated Wavelengths	The From and To limits of each waveband are shown. There can be many wavebands used in a raytrace calculation. TracePro calculates zero or more spectrally-weighted wavelengths for each waveband, as determined by the #Inc entry. Each calculated wavelength is the weighted average wavelength in its waveband increment. For blackbody and graybody sources, the weighting function is the blackbody spectral emissivity optionally multiplied by the spectral absorptance of the surface property (if <i>Angular Dist.</i> is set to <i>Surface Absorptance</i>), and for Surface Source Property sources the weighting function is the spectral emissivity in the property. Rays are traced at the spectrally-weighted wavelengths. Calculated wavelengths are used with Source Property, Blackbody, and Graybody surface sources.

Blackbody Surface Sources

A blackbody absorbs all light incident upon it and emits light in a spectrum derived from the quantum theory of radiation (the Planck blackbody distribution) in a Lambertian angular pattern. The spectral distribution of rays depends on the temperature of the surface.

Approximating a blackbody can be done by creating a cavity and allowing light to escape through a small hole. Most surfaces are poor approximations to a blackbody, but some surfaces (e.g. some special black paints) can approach blackbody performance over a limited range of wavelengths.

Note: By Kirchhoff's law of radiation, the absorptance of a surface is equal to its emissivity. To rigorously simulate thermal radiation in TracePro, you must select the Surface Absorptance Angular Distribution. Then TracePro uses the absorptance of the surface as the emissivity. In this case the surface source is not a true blackbody, but it accurately simulates thermal emission from the surface. If you select a different angular distribution, TracePro sets the emissivity to one.

Blackbody and Graybody Calculations

TracePro computes the radiance to be emitted from the surface source for each waveband defined. The radiance emitted is the integral of the blackbody function between the two boundary wavelengths that define each waveband,

$$L = \int_{\lambda_1}^{\lambda_2} \varepsilon(\lambda) M(\lambda, T) d\lambda, \quad (4.1)$$

where M is the blackbody spectral radiance function, ε is the spectral emissivity, T is temperature, λ is wavelength, and L is the emitted radiance.

Prescription Standard Expert

The Prescription selection in the **Define | Apply Properties** dialog box lets you specify the sequence of lens surface intersections through which an image-forming ray travels. TracePro uses prescription (list of surfaces) for three things: (1) sorting ray paths, (2) automating the set-up of importance-sampling targets, and (3) testing against the Optical Scatter Intercept Limit during the raytrace.

Manual data selection

Surface Number: -1

Automatic data selection

Trace a single ray to order the surfaces and apply prescription numbers

Origin

X: 0

Y: 0

Z: 0

Direction Vector

X: 0

Y: 0

Z: 1

Raytrace Wavelength 0.5461 µm

Set Data

Apply

FIGURE 4.12 - Prescription data

You can specify the sequence of intersections manually or automatically. This tab lets you define the prescription automatically by entering the starting position and direction of the gut ray of the optical system. In an imaging system the gut ray passes through the center of the field of view and the aperture. It defines the optical axis. You can also edit the prescription by manually changing the prescription surface number. A prescription number of -1 applied to a surface means that the surface is not part of the optical prescription.

See “Automatic Setup of Importance Sampling” on page 4.26.

Color

TracePro defaults to green for the display of objects and surfaces in the model window and to black when a user selects an object or surface. To change the default display color, select **View|Options** and change the color selection. To change the color of the object or surface, select **Define|Apply Properties** and select **Color**. Choose a new color by selecting the *Use custom color* button and then clicking on the color bar to display the color selection palette. Select a color from the palette or create a custom color. Click *Apply* to change the color of the object and/or surfaces selected. The color is saved with the Model data.

When applying colors, the surface color takes precedence over the object color, and the object color takes precedence over the default color.

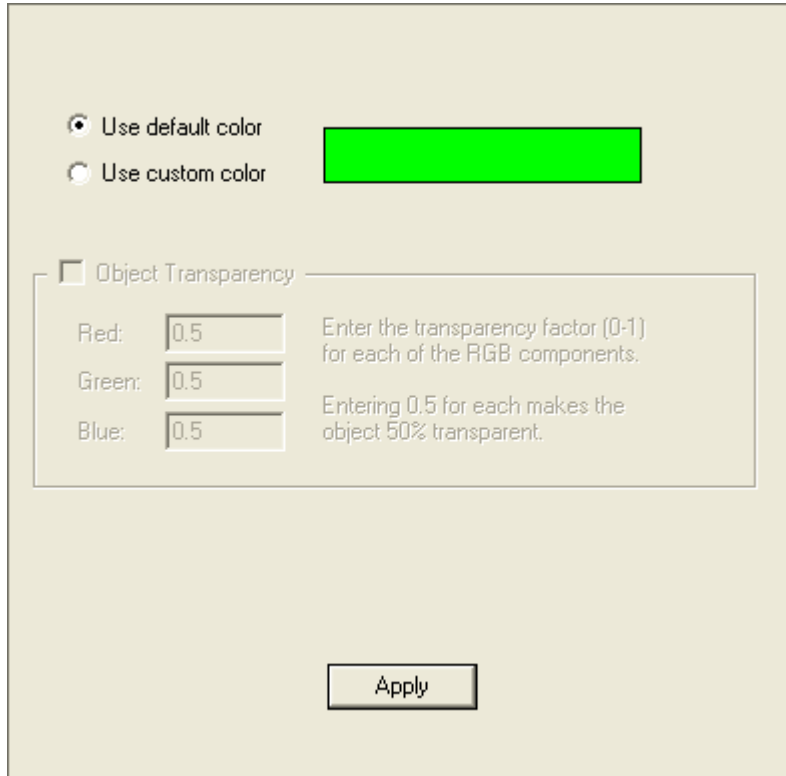

FIGURE 4.13 - Color selection

Object colors may also include transparency. Transparency is specified from 0.0 - 1.0 where 0.0 is opaque and 1.0 is invisible. The values are set for Red, Green and Blue components of the color. Setting Red to 1.0 and Green, Blue to 0.0 would make the object fully transparent to Red objects but opaque for Green and Blue objects. Transparency only affects the display of rendered objects in the Model Window.

Importance Sampling Standard Expert

Importance sampling is a Monte Carlo technique in which rays are generated and propagated in specific directions in the optical system, which are “important” in determining the results you need. This improves sampling by increasing the number of rays reaching the surface or surfaces of interest to you. For a conceptual explanation of Importance Sampling, including a section titled “When Do I Need Importance Sampling?”, see “Importance Sampling” on page 7.2 in the Technical Reference chapter.

Importance Sampling can be applied to improve ray sampling for the following applications:

- Surface Scatter
- Bulk Scatter (see “Bulk Scattering” on page 4.6)
- Diffraction (see “Diffraction” on page 4.32)
- Surface Sources (see “Surface Sources” on page 5.22)

The solid angles for importance sampling are defined by circular, annular, or rectangular planes called importance sampling targets. These virtual targets are not part of the solid model and are used only for importance sampling.

The Importance Sampling Targets are defined in one of two ways, manually or automatically. The Automatic Setup Of Importance Sampling can be used for optical systems for which a sequential prescription of surfaces can be defined, and is usually used for stray light analysis an imaging system. Models containing multiple potential stray light paths require manual setup of the targets. It is also possible to use the Automatic Setup to define Importance targets, and then add additional targets manually.

There are two classes of importance sampling targets, one for surfaces and one for objects. Surface importance sampling targets are applied to surfaces and affect rays generated from surfaces, i.e. due to surface scatter, aperture diffraction and emission by surface sources. Object Importance sampling targets are used for generating bulk scattered rays and emitted fluorescence rays.

Once Importance Sampling targets have been defined, they can also be edited, deleted and displayed. See “Display Importance” on page 2.55.

Defining Importance Sampling Targets Manually

You can manually specify importance sampling targets by selecting **Define|Apply Properties** and choosing Importance Sampling (see Figure 4.14). The Importance Sampling targets dialog box allows you to directly specify the location, orientation, and dimensions of importance sampling targets. You can choose either Rectangular or Annular importance targets.

Note: Importance Targets may be displayed in the Model Window. See “Display Importance” on page 2.55.

Target: 1 of 0 Rays/cell: 1

Direction: Toward Shape: Annular

Target Center Normal Vector Up Vector

X: 0 X: 0 X: 0

Y: 0 Y: 0 Y: 1

Z: 0 Z: 1 Z: 0

Target Size Cells in each dimension

Outer radius: 0 Rings: 1

Inner radius: 0 Slices: 1

Single Surface is selected.

Add Apply Delete

FIGURE 4.14 - The Apply Properties dialog box - Importance Sampling data

The steps required to manually define Importance Targets are as follows:

1. Press *Add* to define a new importance sampling target.
2. Specify the number of importance rays. This is the number of rays generated upon scatter, diffraction, and so forth that are directed to or away from the Importance Target.
3. Specify the direction of the importance rays (either toward or away from the target).
4. Select the shape of the importance sampling target and enter the parameters for the location, orientation, and dimensions of the target.
5. Press *Apply* to store the information and update the surface with the Importance Sampling Property.

These five steps are discussed in more detail in the sections below.

Importance sampling can be further enhanced by specifying more than one importance sampling target for a given scattering surface. As many importance sampling targets as you wish can be specified for each scattering surface.

TABLE 4.3. Fields in the Importance Sampling Dialog Box

Target	Target to add or modify.
Ray/cell	Specify the number of rays you want to go toward (or away from) the target.
Direction	Specify 'Toward' or 'Away' depending on whether you want the rays to go toward the selected importance sampling target or away from it.
Shape	Specify 'Annular' or 'Rectangular' as the shape of the importance sampling target. The remaining dialog box options vary depending on which of these two you have selected.
Target Center	Specify the coordinates x, y, and z to establish the position of the importance sample surface.
Normal Vector	Specify the direction x, y, and z to establish the target normal.
Up Vector	Specify the direction x, y, and z to establish the up direction or height.
Target Size	Specify Outer and Inner radius for Annual target or the X and Y widths for rectangular targets you have selected. An annular region with a zero inner radius will be a circle.
Cells	Specify the number of segments to use for the target. One segment is the default. For more information about "Cells", see page 4.24.
Add Button	Press this button to add an importance sampling target as currently defined by the rest of the dialog box. To associate importance sampling with a particular surface, you must first select that surface in your model before you press the Add Button.
Apply Button	Press this button when you have completed defining or editing properties for the selected importance sampling target so that the changes take effect.
Delete Button	Press this button to delete the displayed Importance Target

Adding Targets

To add an importance sampling target:

1. Select **Define | Apply Properties**.
2. With the *Apply Properties* dialog box open, select the Importance Sampling tab.
3. Select a surface (for surface scatter, diffraction, or surface source) or object (for bulk scatter) to which to apply an importance sampling target. Note that in the dialog box, a small drop-down box displays the number of importance sampling targets currently defined on the surface that you select.
4. Press the *Add* button to add an empty target.
5. Enter the values for the target direction, shape, size and orientation.

6. Enter the number of rays to target to each cell.
7. Press Apply to save the data and apply the target.

You can also reach the manual setup of importance sampling by clicking the model window with the right mouse button, then by selecting Properties from the pop-up menu obtained.

Number of Importance Rays

Importance sampling will collect the flux from a random ray, caused by scattering for example, and aim it towards the defined target. The flux can be divided into multiple rays to improve the sampling of the ray trace by directing many rays toward each importance sampling target

If the importance sampling target subtends too large a solid angle OR the BSDF of the surface varies significantly (more than an order of magnitude) over the subtended angle OR if more sampling is desired, divide the target into cells.

Shape, Dimensions, and Location of Importance Targets

When setting up importance sampling targets manually, it is important that the solid angle subtended by the importance sampling target is less than one steradian. It might be necessary to select multiple samples to keep the solid angle of each segment small. This is especially important if the BSDF varies strongly with angle (for example, for a polished surface such as a mirror or lens). Reducing the size of the target or using multiple cells can overcome this issue.

Cells

When it is important to have more uniform sampling than is provided by pure random sampling, use this option to divide each dimension of the target into segments, creating smaller cells in which random ray aiming points are selected.

Stratified Importance Sampling

If the importance sampling target subtends too large a solid angle, or the BSDF of the surface varies significantly (more than an order of magnitude) over the subtended angle or if more uniform sampling is desired, you should divide the importance sampling target into cells to create a stratified target. A circular or annular target is partitioned into segmented rings of equal area as shown in Figure 4.15. This is done by dividing the annulus equally in angle and calculating radii to give equal area to each cell.

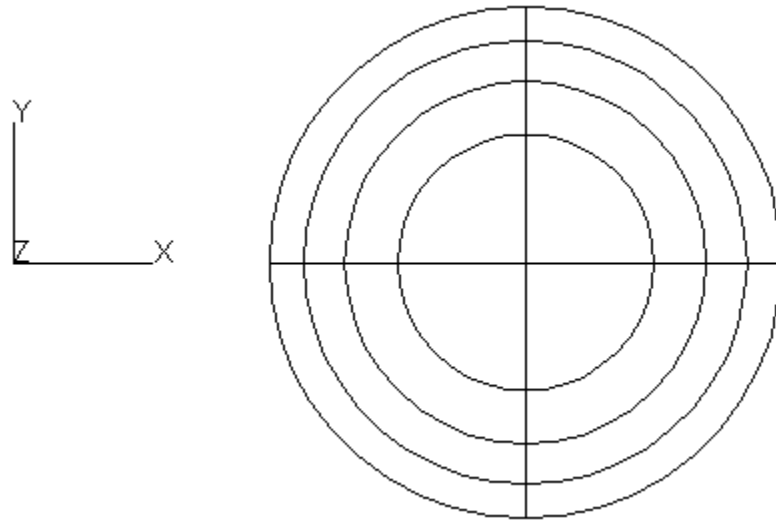

FIGURE 4.15 - Stratified annular (circular in this case) importance sampling target with four radial segments and four azimuthal segments. The 16 resulting cells all have equal area.

The radii of the rings are determined by the formula

$$r_{i+1} = \sqrt{\frac{A}{\pi n} - r_i^2} \tag{4.2}$$

where n is the number of rings, the ring edges are numbered $0, \dots, i, \dots, n$, A is the area of the annular target ($A = \pi(R_{outer}^2 - R_{inner}^2)$), and r_i is the radius of ring edge i . r_0 is equal to R_{inner} , the inner radius of the annular target. For a circular target, $R_{inner} = 0$.

A rectangular target is partitioned into segmented rectangles of equal area as shown in Figure 4.16.

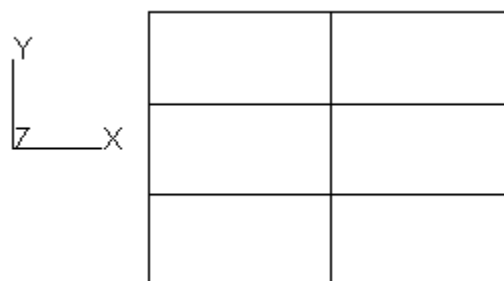

FIGURE 4.16 - Rectangular target with 2x3 (XxY) segments.

Rectangular segments are all the same shape as well as being equal in area.

To specify the segmentation of an importance sampling target, select the number of cells in each direction (radius and angle for an annular target, x and y for a rectangular target).

Apply the Importance Sampling Property

Once the number of importance rays, the direction of the importance rays, the shape of the importance target and the location, orientation, and dimensions of the target have been defined, verify that the proper surface or object is selected in the System Tree, and click *Apply* to apply the Importance Sampling Property.

Automatic Setup of Importance Sampling

For complex optical systems of many lenses that require scatter and stray light analyses, manually defining the importance sampling targets for each surface is complicated and time-consuming. TracePro lets you define Importance Sampling targets for all the optical surfaces automatically.

The following discussion assumes you are familiar with the terminology of optical imaging.

Define the Prescription

Prior to the automatic set up of importance sampling targets, you must first define the prescription, which is a sequence of surfaces that light rays pass through. Use the prescription tab of the **Define|Apply Properties** dialog box to define the prescription. For more information about “Prescription”, see page 4.18.

Select the Target Shape

After the prescription is correctly set up, select the **Define|Auto Importance Sampling** dialog box, labeled Automatic Setup of Importance Sampling (see Figure 4.17). Specify the importance sampling target shape as annular or rectangular for the surfaces in the prescription.

Choose the target shape (annular or rectangular) that most closely matches the shape of the field of view of the optical system. You can choose a circular field of view by selecting the Annular radio button.

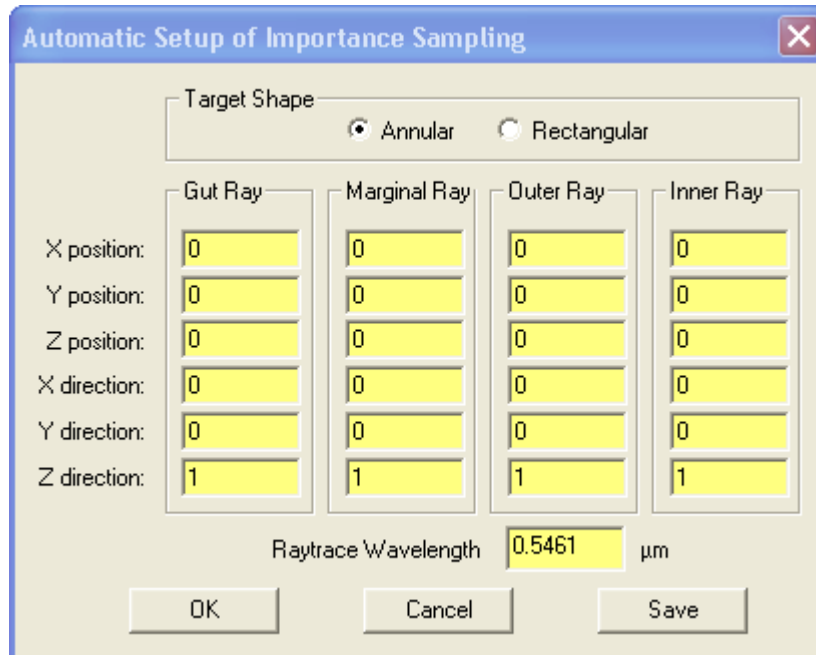

FIGURE 4.17 - Automatic Setup of Importance Sampling Dialog Box

Specify a gut ray, marginal ray, and one or two chief rays.

- | | |
|--------------|--|
| Gut Ray | A ray passing through the center of the aperture stop and the center of the field of view. |
| Marginal Ray | A ray passing through the edge of the aperture stop and the center of the field of view. |
| Chief Ray | A ray passing through the center of the aperture stop and the edge of the field of view. For an Annular target specify an Outer Chief Ray and an Inner Chief Ray. For a Rectangular target specify a Height Chief Ray and the Width Chief. |

In some cases, it is helpful to use a lens design program such as OSLO to determine the starting positions and directions of the rays. Two chief rays are needed to define rectangular or annular targets. To define circular importance sampling targets, select Annular and leave the data for the Inner Ray set to all zero.

Note: If the gut ray is blocked by the optical system (e.g. by the secondary mirror in a Cassegrain Telescope) move the gut ray to the inner edge of the obscured aperture, keeping its direction the same.

Annular Targets

To define importance sampling for annular targets, enter the required data for the rays. The Inner Ray is one that passes through the center of the aperture stop and the inner edge of the annulus, as shown in Figure 4.18. The Outer Ray passes through the outer edge of the annulus, on a line passing through the Gut Ray and Inner Ray points.

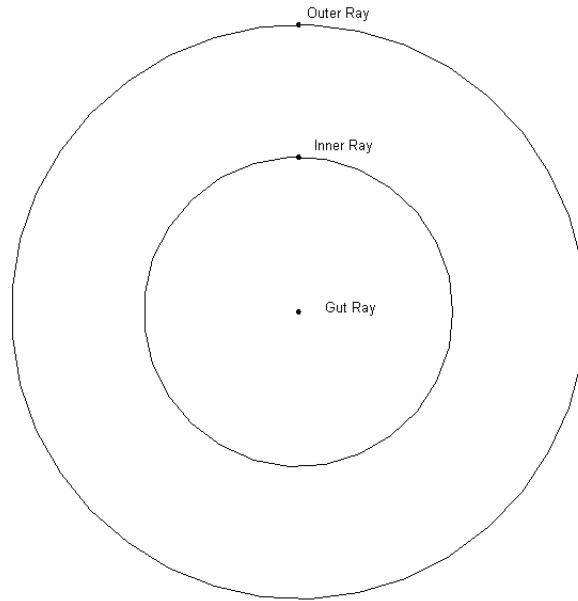

FIGURE 4.18 - Ray locations for automatic setup of importance sampling targets with an annular field of view

Rectangular Targets

To define importance sampling for rectangular targets, enter the data for the rays. The Height Ray passes through the center of the aperture stop and the center of one edge of the image rectangle, as shown in Figure 4.19, and the Width Ray passes through the center of an adjacent edge. The Marginal Ray passes by the edge of the aperture and meets the image field at the same location as the Gut Ray. TracePro calculates the distance and location of the image field from the meeting point of Marginal and Gut Rays.

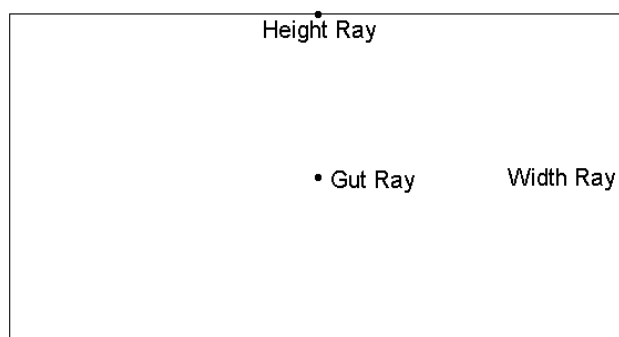

FIGURE 4.19 - Ray locations for automatic setup of importance sampling targets with a rectangular field of view

Apply, Cancel, or Save Targets

Once the prescription is defined, the target shape is selected, and the gut, marginal, and chief rays are specified, click on one of the buttons at the bottom of the dialog:

- **OK:** This will trace the rays defined and perform the importance sampling setup. The dialog will be closed.
- **Cancel:** This will close the dialog without tracing any rays. All updated data will be lost.
- **Save:** This will add Grid Sources corresponding to the four rays defined in the dialog. No rays are traced. Each time the button is pressed new Grid Sources are added to the model. To trace you must trace the rays per a grid/all source ray trace.

Editing/Deleting Importance Sampling Targets

You can check and edit the manually or automatically defined importance sampling targets using the Importance Sampling tab of the **Define | Apply Properties** dialog box. Select the surface with the Importance Sampling tab open, then select the importance sampling target you want to edit from the drop-down list. Make changes to the parameters in the dialog box, then select *Apply*.

To delete an importance sampling target, select the importance sampling target number from the dialog box drop down list. Click the *Delete* button to remove the importance sampling target.

Exit Surface

When using Simulation Mode to reduce the length and burden of computations, you must designate one or more surfaces as Exit Surfaces to display Irradiance Maps.

FIGURE 4.20 - Exit Surface data in Apply Properties dialog box

TracePro optionally collects flux and incident ray coordinates and directions for each surface in addition to collecting data for candela plots. Rays do not necessarily “exit” on this surface, but this is a commonly used term for this surface.

Once the Exit Surfaces are defined, rays may be traced in Simulation Mode. To view analysis output, Select a surface as if using Analysis Model and display the plot. If the plot is displayed and no selection is made the data from the first Exit Surface defined will be used. If an object or non-exit surface is selected a message will be displayed in any open plots or tables requesting the selection of a valid Exit Surface.

Before beginning a raytrace in Simulation Mode, you must first specify the exit surface(s). Do this by the following sequence:

1. Select the surface for which you want to collect flux and irradiance data.
2. Select **Defi ne | Appl y Propert i es** to open the dialog box.
3. Choose the Exit Surface tab in the dialog box.
4. Check the Exit Surface check box.
5. Click the Apply button at the bottom of the dialog box.

TABLE 4.4. Exit Surface Options.

Exit surface	Set the check box to enable/disable the surface's Exit surface property.
Number of reverse rays	Set the number of ray to trace during Reverse Raytrace (Standard and Expert Only)
Name	Selects one of the Predefined Irradiance Map orientations.
Add	Add a new Irradiance Map orientation.
Modify	Modify a new Irradiance Map orientation.
Delete	Delete a new Irradiance Map orientation.

Standard

Expert

The Exit Surface dialog is used to define the number of Reverse Rays to trace when using Reverse Raytrace. See "Reverse Ray Tracing" on page 5.36.

Predefined irradiance map orientation

The Predefined irradiance map orientation is used to define the Normal and Up vectors for Irradiance Maps and the Irradiance Map viewer. See "Irradiance/Illuminance Viewer" on page 6.72. The data and dialog are shown in Table 4.5 and Figure 4.21 respectively.

TABLE 4.5. Irradiance Map Orientation Options.

Name	Sets the Predefined Irradiance Map orientation name.
Normal Vector	The Normal Vector is a vector in 3D space that is used to orient the projection plane for the irradiance map. The plane is defined to be perpendicular to the Normal Vector, and the irradiance incident on the selected surface is projected onto this plane.
Up Vector	The Up Vector is a vector in 3D space that is used to orient the projection plane for the irradiance map. The plane is defined so that the Up Vector is parallel to the vertical side of the plane. The irradiance incident on the selected surface is projected onto this plane.

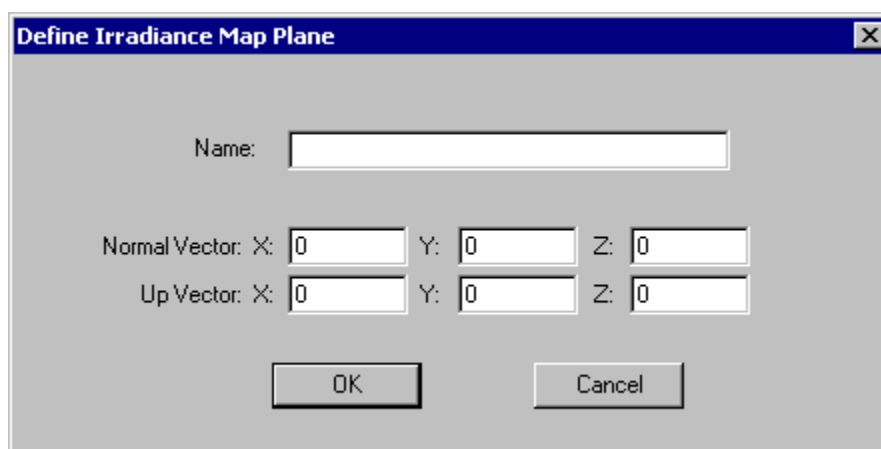
**FIGURE 4.21 - Irradiance Map orientation dialog**

Diffraction Standard Expert

Aperture diffraction is light “bending around obstacles.” TracePro can model edge diffraction, also called aperture diffraction, which occurs when light is partially blocked by an edge. The method TracePro uses for modeling diffraction is asymptotically correct, i.e., it is correct for large-angle or wide-angle diffraction. This asymptotic method is based on the Heisenberg Uncertainty Principle for photon position and momentum (ref. Freniere et al, Proc SPIE Vol. 3780 (1999)).

(See “Aperture Diffraction Example” on page 9.22.)

Defining Diffraction in TracePro

Diffraction results in interference downstream from the obstacle. When light passes an obstacle and part of it is blocked by the obstacle, diffraction occurs. This physical process places a limit on the resolution of a lens and may cause stray light.

Diffraction is an interference phenomenon. When light waves propagate unobstructed, they are continuously and constructively interfering as they propagate. In other words, the interference pattern is in some state of equilibrium, providing a wavefront that describes the propagation from each point of the emitter. When a wave is interrupted by an obstacle, the wavefront equilibrium is upset. Thus, interference ripples occur upon further propagation. In the far field, an equilibrium is reestablished. When a wave is interrupted by an obstacle, the wavefront is suddenly incomplete. Interference ripples occur.

A two-dimensional diffraction-interference phenomenon can be observed when water waves strike a breakwater. A long, straight wave striking a breakwater (with the wave parallel to the breakwater) results in approximately circular waves emanating from the end of the breakwater. Far away from the breakwater, the original straight wave continues uninterrupted. The circular wave interferes with the straight wave in the “slit” region, causing interference maxima and minima--and causes waves to go into the “shadow” region where the casual observer might not expect waves to go at all. This effect is analogous to the diffraction of light.

A complete theoretical treatment of diffraction is a mathematical subdiscipline of physics, and is beyond the scope of this manual. For the interested reader, an introductory treatment of diffraction can be found in most any optics textbook. Some additional technical details can also be found in the Technical Reference section.

Do I need to Model Diffraction in TracePro?

TracePro’s implementation of diffraction modeling is designed for stray light analysis and for system transmission studies of specialized optical instruments where diffraction might have a significant effect on transmittance.

Generally, image quality diffraction studies are done using optical design software such as OSLO.

If you are modeling diffraction for stray light, it is necessary to define importance sampling for each diffracting aperture in the optical system. The importance

sampling target for the diffracting aperture is applied to the surface that is defining the edge of the aperture.

How do I Set Up Diffraction?

Diffraction occurs in TracePro at a surface on which a diffraction property is defined. Setting up diffraction on a surface consists of four steps:

1. Select a surface on which you want to model diffraction. It can be the surface of a mirror or lens. If there is no surface where you want to model diffraction, you must define a “dummy object.” Locate the dummy object where you want the diffraction to occur, and select one surface of the object.
2. Place a check in the *Aperture Diffraction* check box located on the Diffraction tab of the **Define|Apply Properties** dialog box.
3. Set the Aperture Diffraction check box in the *Raytrace Options* dialog box found on the **Analysis** menu. This turns on diffraction for the current model.
4. Add importance targets to the aperture surface. For more information about “Importance Sampling”, see page 4.20.

Using the Raytrace Flag

The raytrace flag property lets you exclude an object from a raytrace, which can speed up the raytrace. During the audit prior to the start of a raytrace, messages are displayed in the Macro/ Message Window to remind you which surfaces you have excluded from the raytrace.

To exclude an object from the raytrace, select the object. Select **Define|Apply Properties** and then select Raytrace Flag. Uncheck the check-box and click *Apply*.

Mueller Matrix Standard Expert

You can create and apply a polarizing element to a TracePro object by specifying its Mueller matrix. TracePro uses the Stokes vector-Mueller matrix method (Mueller calculus) for modeling polarized light.

Use the **Define|Apply Properties** dialog box and select Mueller Matrix to apply polarization to a TracePro object. You can specify the polarization state of Grid Source rays using the *Grid Source* dialog box, Polarization tab.

Component: Linear Polarizer

Transmission Axis: 0 deg (horizontal)

Mueller Matrix

0.50000000	0.50000000	0.00000000	0.00000000
0.50000000	0.50000000	0.00000000	0.00000000
0.00000000	0.00000000	0.00000000	0.00000000
0.00000000	0.00000000	0.00000000	0.00000000

Propagation Direction

X: 0.00000000

Y: 0.00000000

Z: 1.00000000

Up Direction

X: 0.00000000

Y: 1.00000000

Z: 0.00000000

Faraday Type

Apply

Delete

FIGURE 4.22 - The Apply Properties Dialog Box - Mueller Matrix

If you specify a *Mueller matrix*, you must also specify its orientation. Do this by specifying the “Up Direction” vector and the “Propagation Direction” vector at the bottom of the dialog box. Orientation vectors are specified in global coordinates. The direction vector specifies the direction in which light is traveling when the Mueller matrix has the specified effect.

TABLE 4.6. Mueller Matrix Options.

Component	Selects one of several predefined types of polarizing components.
Transmission Axis	Orientation in degrees for Linear Polarizer.
Handedness	Choice of Left or Right for Circular Polarizer and Circular Halfwave Retarders.
Fast Axis to X Axis	Orientation in degrees for Linear Quarterwave Retarders and Linear Halfwave Retarders.
Mueller Matrix	Displays the terms of the 4x4 Mueller Matrix for the current polarizing component. This is also used in the Custom component is selected to define the polarizer. These must be normalized terms.
Propagation Direction	Global propagation direction of the object. This is automatically be updated if the object is rotated or moved.
Up Direction	Up direction in global coordinates of the object. This automatically be updated if the object is rotated or moved.
Apply	Apply or update the property data to the object(s).
Delete	Remove the property from the object(s).

If you know the values of the Mueller Matrix or the component does not conform to one of the standard types select the Custom Component. The following options are displayed.

TABLE 4.7. Options for Custom Mueller Matrix Data Entry.

Manual Entry	Enables direct entry into the Mueller Matrix array.
Compensator	Displays the Phase Difference options. Phase Difference is entered in degrees or radians.
Rotator	Displays the Rotation Angle option. Rotation Angle is entered in degrees or radians.
Linear Polarizer	Displays the Orientation Angle option. Orientation Angle is entered in degrees or radians.

When a ray traverses an object, the Stokes vector of the ray is transformed to the coordinate system of the Mueller matrix and then multiplied by the Mueller matrix to determine the new polarization state of the ray. Any flux that is absorbed by the Mueller matrix is recorded as the ray enters the object. That is, the incident flux on the surface as the ray leaves the object is lower in the amount absorbed by the Mueller matrix, similar to bulk absorption.

A Mueller matrix is a 4x4 matrix and a Stokes vector is a column vector of length 4. Therefore, multiplying a Stokes vector by a Mueller matrix produces a new Stokes vector. In this way a Stokes vector can be propagated through an optical system. For example, a Mueller matrix that does nothing is the unit matrix,

$$\begin{bmatrix} 1 & 0 & 0 & 0 \\ 0 & 1 & 0 & 0 \\ 0 & 0 & 1 & 0 \\ 0 & 0 & 0 & 1 \end{bmatrix},$$

while a horizontal polarizer is represented by

$$\begin{bmatrix} 0.5 & 0.5 & 0 & 0 \\ 0.5 & 0.5 & 0 & 0 \\ 0 & 0 & 0 & 0 \\ 0 & 0 & 0 & 0 \end{bmatrix}$$

The Stokes vector for unpolarized light is

$$\begin{bmatrix} 1 \\ 0 \\ 0 \\ 0 \end{bmatrix}$$

while the Stokes vector for perfectly horizontally polarized light is

$$\begin{bmatrix} 1 \\ 1 \\ 0 \\ 0 \end{bmatrix}$$

There is a collection of example Mueller matrices and Stokes vectors in the Technical Reference section. Discussions and examples of Mueller matrices and Stokes vectors can be found in many textbooks (for example, E.L. O'Neill, [Introduction to Statistical Optics](#), Dover, ISBN: 0486673286 (1992); E. Collett, [Polarized Light: Fundamentals and Applications](#), Dekker, ISBN: 0824787293 (1992); Shurcliff and Ballard, [Polarized Light](#), van Nostrand (1964); Kliger, Lewis, and Randall, [Polarized Light in Optics and Spectroscopy](#), Academic Press, ISBN: 0124149758 (1990)).

Mueller matrices must be defined with care – it is quite possible to create a Mueller matrix that is impossible, i.e. one that creates a resulting Stokes vector that is not physically possible.

Temperature Standard Expert

TracePro has a Surface and Object property for temperature. Material and Surface properties have data based on wavelength and temperature. During the raytrace audit the property data is updated to reflect the current surface and object temperatures. If an object has a defined temperature but the surfaces do not, the object temperature is applied to the surfaces. If no temperature is defined, the default value for the property is used.

As an example, consider a simple material property named “Temperature,” which has an index of 1.5 for 300K and 2.5 at 500K. The raytrace for the two cases is shown. The flux threshold has been set to 5% to eliminate most Fresnel reflections.

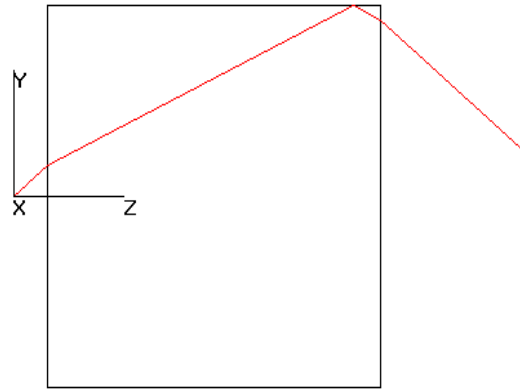

FIGURE 4.23 - Raytrace of block with example “Temperature” material applied, with $n = 1.5$ at $T=300K$

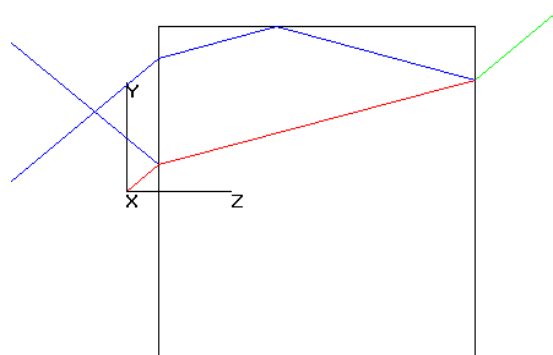

FIGURE 4.24 - Raytrace of block with example “Temperature” material applied, with $n = 2.5$ at $T=500K$

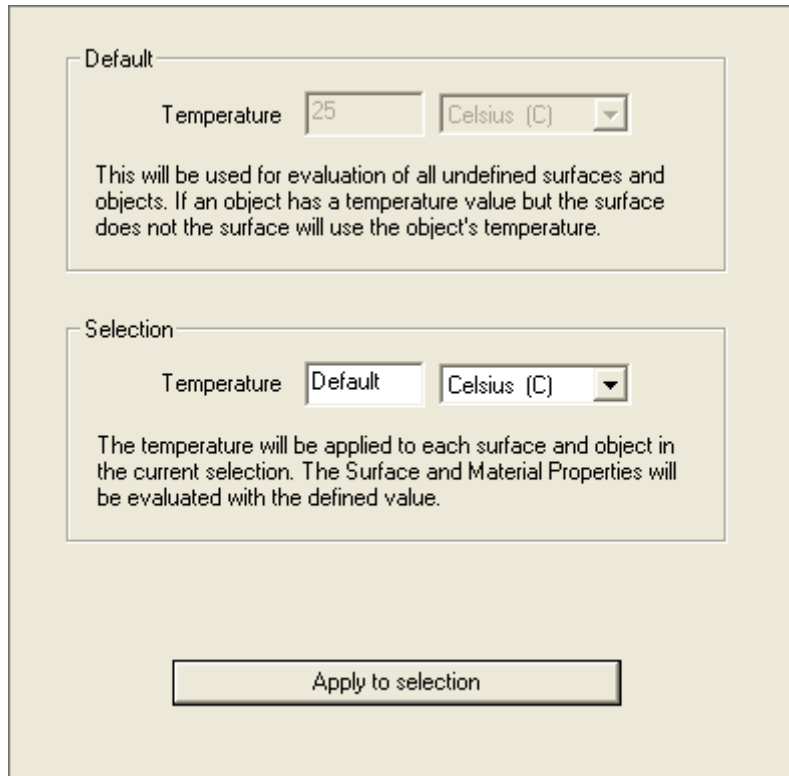

FIGURE 4.25 - Apply Properties Dialog Box, Temperature

Temperature is applied like any other property, through the Apply Property dialog box. After selecting the objects and surfaces of the same temperature, enter the new temperature and press Apply to update the model.

For surface temperatures, you can define a temperature distribution that varies continuously over the surface. See “Temperature Distribution” on page 4.53.

Temperature is entered in units of degrees C, degrees F, or Kelvin.

Note: If a property is defined at only a single temperature, the surface and object temperatures are effectively ignored.

Note: The Default temperature is set in **View|Options**.

Class and User Data Standard Expert

The Class Data feature lets a user apply a string attribute and numeric data to one or more objects. The Class Name is displayed in various outputs and is accessible from the macro language. See the online Macro Reference for further information on specific macro commands.

To apply class data to one or more objects:

1. Select the objects using the **Edit|Select|Objects** tool.
2. Open the Apply Properties dialog.
3. Select the Class and User Data tab and enter the name to be applied.
4. Press Apply to update the object selection. The Class Name and User Data values will be attached to the object.

The image shows a dialog box titled "Apply Properties Dialog Box, Class and User Data". It is divided into two main sections: "Object Class" and "User Data".

- Object Class:** Contains a label "Class Name:" followed by a dropdown menu currently displaying "Sphere".
- User Data:** Contains three input fields labeled "Value 1:", "Value 2:", and "Value 3:". Each field contains the number "0". To the right of these fields is a button labeled "Delete Values".

At the bottom center of the dialog box is a button labeled "Apply".

FIGURE 4.26 - Apply Properties Dialog Box, Class and User Data

User data is also available to apply numeric data to one or more objects. This data may be used during macro operations to store values used during the course of ray tracing.

The Property Report and System Tree display the applied Class and User data.

The Online Macro Reference provides detailed descriptions of the macro commands used with Class and User data. See **property:get-user-data** and **property:get-class**.

RepTile Surfaces Expert

Overview

When modeling objects that have many small repeated structures, it may be infeasible to create the structures using TracePro or any other solid modeling program. For example, brightness-enhancing films used in flat-panel LCDs may have thousands or millions of repeated surface structure elements. The RepTile surface feature in TracePro allows you to create these objects by specifying the shape of one tile, or one column of tiles. This feature allows you to create complicated models with a great reduction in model size, audit time, and ray-trace time compared to equivalent models with solid geometry.

Specifying a RepTile surface

The process of making a RepTile surface in TracePro is similar to applying a surface property. TracePro has a database of different RepTile surface shapes and geometries, and you can define different RepTile parameters and add them to the database. The database is accessed through the RepTile Property Editor. Different tile shapes (ring, rectangular, staggered rectangular, and hexagonal) and tile geometries (conical, spherical, ellipsoidal, hip-roof, cube-corner, prism, rounded prism, and Fresnel lens) are available. In general, the geometries can be defined as either “bumps” or “holes”. Once a RepTile property is entered in the database (see “RepTile Surfaces” on page 4.39), it can be applied to a plane surface using the RepTile tab of the Apply Properties dialog box. Additional data is also needed, namely a boundary (rectangular, circular, or the boundaries of the object) on the plane surface within which the tiles exist, and the location of a reference tile (the (0,0) tile). These data are entered in the RepTile tab of the Apply Properties dialog box.

Important note: You can avoid ray tracing errors in RepTile by avoiding coincident surfaces. For example, avoid having boundary dimensions that place the RepTile boundary coincident with a tile boundary, or vice versa. Likewise, do not create features within tiles that have surfaces that are coincident with tile boundaries. The RepTile ray tracing engine is optimized for speed and does not check for such coincident surfaces.

The image shows a software dialog box titled "RepTile Property Editor". It is divided into two main sections: "Property Data" and "Boundary and Orientation".

Property Data:

- Catalog: Default (dropdown)
- Name: <None> (dropdown)
- Text field: Not found in database
- Surface Catalog: Default (dropdown)
- Surface Name: <None> (dropdown)

Boundary and Orientation:

- Shape: Rectangular (dropdown)
- Width: 1 (text field)
- Height: 1 (text field)

Below these are four columns of coordinate input fields:

Boundary Center	Origin for tile (0,0)	Tile Up	Boundary Up
X: 0	X: 0	X: 0	X: 0
Y: 0	Y: 0	Y: 1	Y: 1
Z: 0	Z: 0	Z: 0	Z: 0

At the bottom of the dialog are three buttons: "Export", "Apply", and "View Data".

FIGURE 4.27 - RepTile Property data

TracePro permits one RepTile property per Surface. So a Block with 6 surfaces could have up to 6 RepTile properties, one on each surface.

When you apply a RepTile property to a plane surface, TracePro defines a “cell” containing the tiled space. The cell has the shape of the boundary (circular, rectangular, or surface bounds) and a calculated depth. If the RepTile property is Parameterized then the cell depth is entered in the dialog. Otherwise the depth of the cell is as follows:

- The depth or height, d , of the deepest or highest geometry is calculated.
- A buffer of 0.001 mm is added to each side.

The total depth of the cell is $d + 0.002$ mm, and all geometry surfaces are at least 0.001 mm from the top and bottom planes that bound the cell. You must be aware of this calculated depth, because the cell must be completely contained within the object that owns the RepTile surface. If this rule is violated, incorrect rays will result. Another way to think of this is that the cell “sticks into” the surface by a distance $d + 0.002$ mm (this is true for both “holes” and “bumps”). There must also be a margin around the edges of the cell. That is, the cell boundary should not be coincident with any surface of the object in order for rays to escape. This margin can be small, e.g. 0.001 mm, but it should not be zero or errant rays will result.

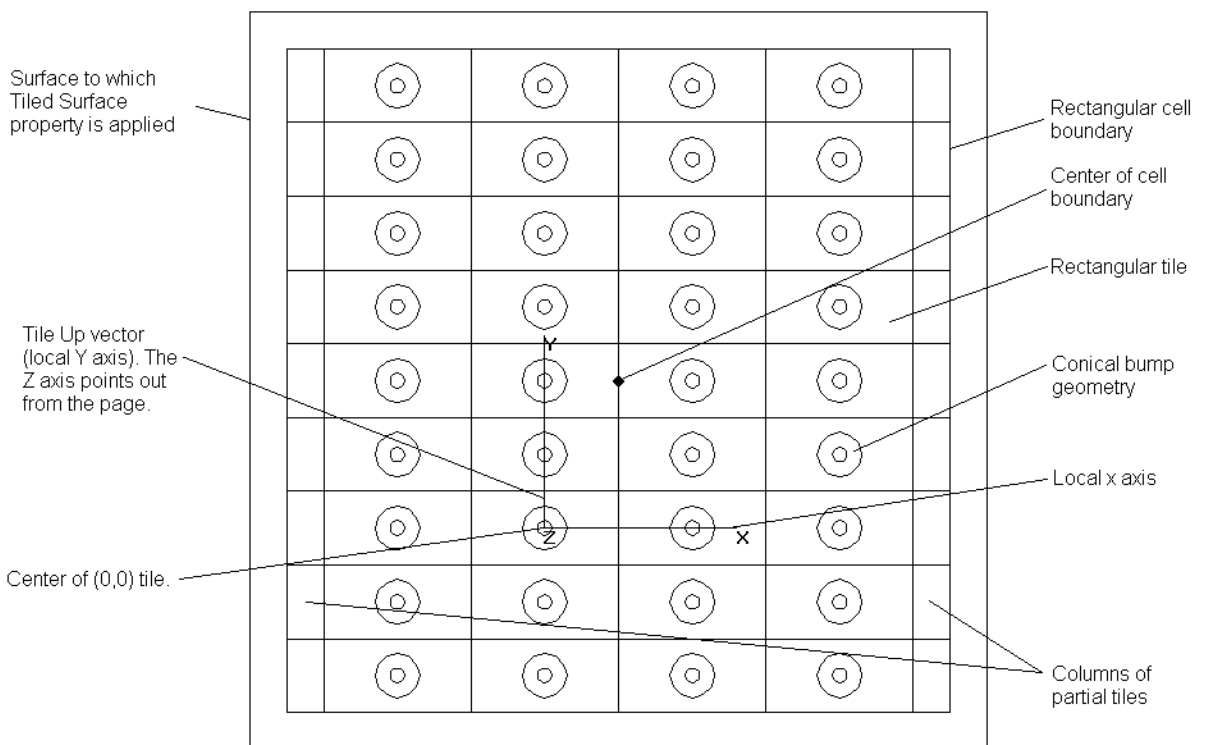

FIGURE 4.28 - A completed RepTile Surface. The tiled region has a rectangular boundary, and the tiles are rectangular with conical geometry. The tile numbering increases along the x and y axes. Tiles along the local x axis are in rows, and those along the local y axis (the Up vector) are in columns.

The orientation of tiles in a RepTile surface is determined by the Tile Up Vector you enter when applying the RepTile Surface property to a surface. The direction of the Tile Up Vector defines the local y axis of the tiles, the plane normal vector

defines the local z axis, and the local x axis is orthogonal to the y and z axes and forms a right-handed coordinate system. The boundary is oriented according to the Boundary Up Vector entered. The Height of the boundary is measured along the Boundary Up Vector. The width of tile shapes and geometry is the dimension along the local x axis, and the height is along the local y axis (the Tile Up vector). Depth/height of “bumps”/ “holes” is along the local z axis.

Figure 4.28 shows a rectangular plane surface with a RepTile Surface property applied to it. You specify the (x, y, z) location of the (0,0) tile. The tile numbering increases along the x and y axes. The tile directly above the (0,0) tile is (0,1), and the tile to the right of the (0,0) tile is (1,0). In general, a tile is referred to by its coordinates (n_x, n_y) . When you select variable geometry, the geometry varies as n_y varies, so that for a given n_y , all the n_x tiles are the same as shown in Figure 4.28.

When you enter the coordinate of the (0,0) tile, it doesn't have to be on the surface. If it is above or below the surface, the point will be projected onto the surface along the surface normal. If the point is outside the boundary of the surface, some of the tiles (or fractions of tiles) will not be used, but this is a perfectly valid way to use the RepTile Surface feature.

Depth for Parameterized Reptile

When a RepTile property is defined as Parameterized, the depth is entered in the Apply Properties Dialog. These properties allow the RepTile feature to be truncated by or immersed in the Object containing the property.

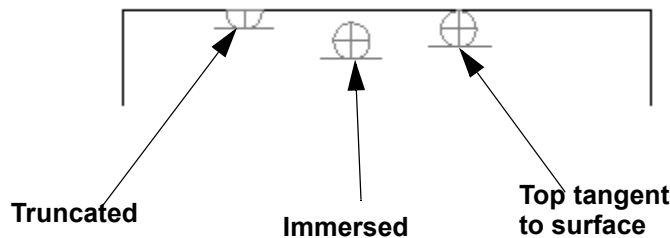

FIGURE 4.29 - Parameterized Spherical Bumps at three different depths.

Figure 4.29 shows an example using Spherical Geometry for three different Boundary Depths.

- The Truncated case has a Boundary Depth less than the Geometry Depth.
- The Immersed case has a Boundary Depth greater than the Geometry Depth.
- The third case has the two depths being equal.

The horizontal line below the sphere is the Boundary surface defined by the RepTile property.

Boundary Shapes

Circular boundary

You specify a circular boundary by a center point (x, y, z) and a radius. When you specify a circular boundary, TracePro creates a disk-shaped cell to contain the

tiles. It is important that circular boundary be completely inside the boundaries of the surface, otherwise ray tracing errors will result.

Rectangular boundary

You specify a rectangular boundary by a center point (x, y, z), Boundary Up vector, width, and height. When you specify a rectangular boundary, TracePro creates a rectangular cell to contain the tiles. It is important that rectangular boundary be completely inside the boundaries of the surface, otherwise ray tracing errors will result.

Use Surface Bounds

No additional data is needed to define this type of boundary.

When you use the surface bounds as RepTile bounds, TracePro assumes that the surface to which the RepTile is applied is on a convex part of the object. Imagine two infinite planes that define the top and bottom of the RepTile cell. Rays may enter the RepTile cell from outside the object in either of two ways: 1) by intersecting the surface to which the RepTile is applied; or 2) by intersecting another surface of the object between these two infinite planes. With this type of boundary, a ray can enter the RepTile cell from inside the object only by intersecting the bottom plane.

Export

The RepTile surface information can be exported to a file. TracePro provides a text format containing the a description of the property with defining data. The geometry can be exported as a 2 dimensional mask or 3 dimensional wireframe in DXF format. In all cases, the property must first be applied to a surface to enable the Export function.

Visualization and Surface Properties

See “Display RepTile” on page 2.54.

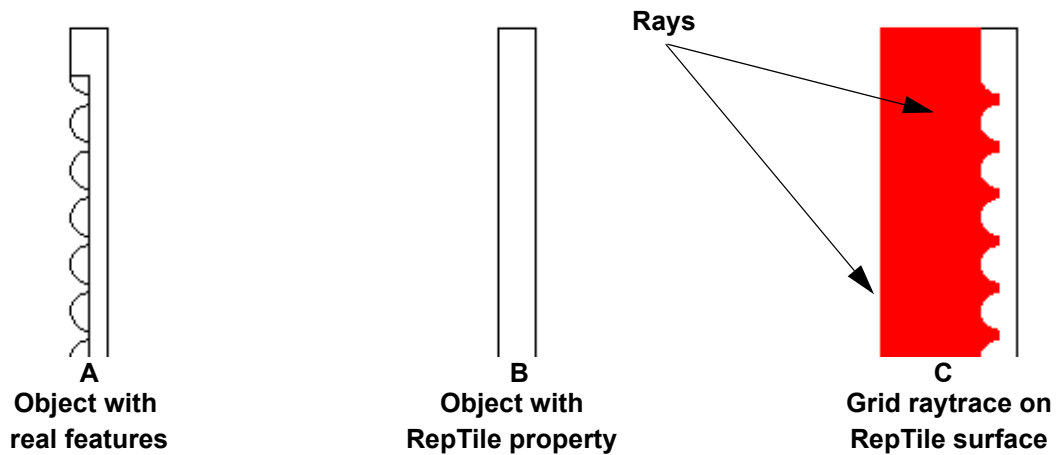

FIGURE 4.30 - Cross section of different representations of objects - each with a surface containing spherical “bumps”.

Figure 4.30 shows different representations of objects containing an array of spherical “bumps” applied to the left hand side of an object in the TracePro Model Window. Figure 4.30A shows the side profile of an object as it would appear when the surface “bumps” are created as a true solid model. In order to create this object, several spheres had to be unioned together into a single solid model object. Figure 4.30B shows the side profile of an alternate approach: a RepTile surface is applied which represents the same geometry as that in Figure 4.30A. You can clearly see that the RepTile surface features are not displayed in the object of Figure 4.30B. Figure 4.30C illustrates the recommended way to visualize a RepTile surface: a *Perfect Absorber* surface property is applied to the RepTile surface and a single column of closely spaced rays is traced using a grid raytrace. The ends of the rays, as they become absorbed by the RepTile surface, display the profile of the surface geometry.

Two different surface properties can be applied in different ways on the same RepTile surface. As shown in Figure 4.31, a surface property can be applied to RepTile features by changing the *Surface Property* in the *RepTile* tab of the *Apply Properties* dialog. Figure 4.31 illustrates that a different surface property can still be applied to the underlying surface by specifying the *Surface Property Name* in the *Surface* tab of the *Apply Properties* dialog. Note that any “border” regions of a tile (i.e. regions around the edge of each tile devoid of a RepTile “bump”, “hole” or any other feature) are assigned the surface property of the underlying surface. Likewise, surface properties applied to the underlying surface of the RepTile surface are also applied to the surface frame which surrounds the RepTile cell boundary (see notation on schematic in Figure 4.32).

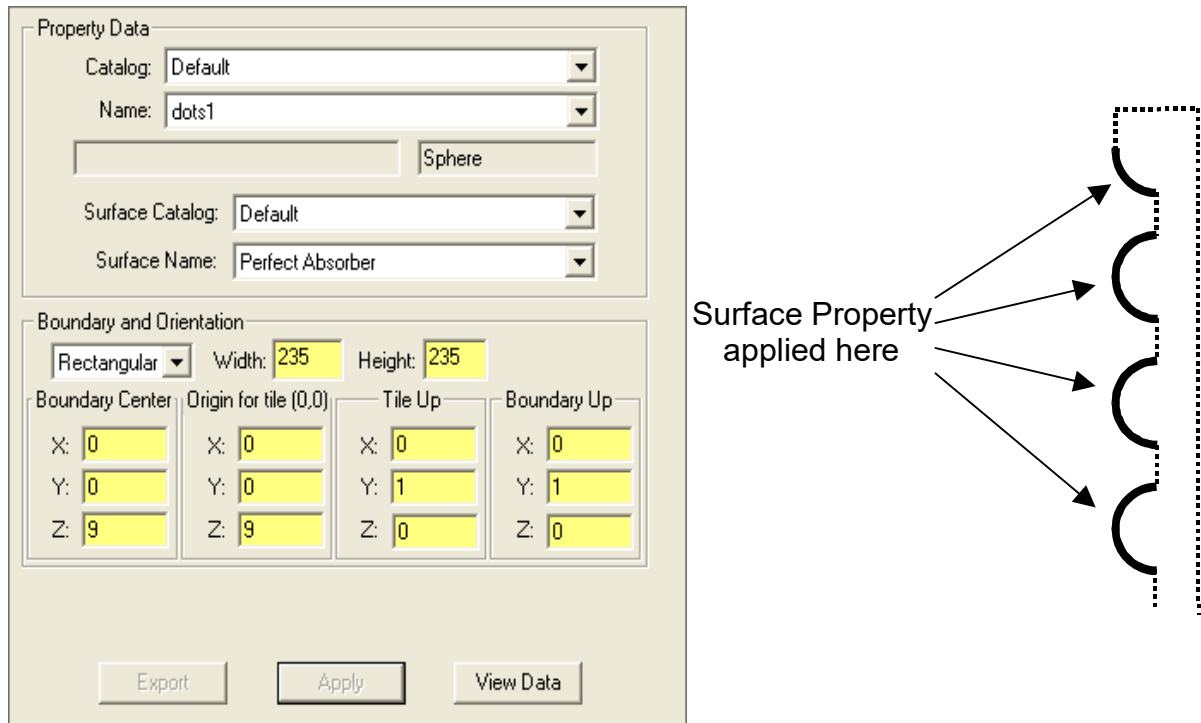

FIGURE 4.31 - Applying a surface property directly to RepTile features in the Apply Properties dialog. The surface property will apply to the surfaces drawn with bold lines in the schematic.

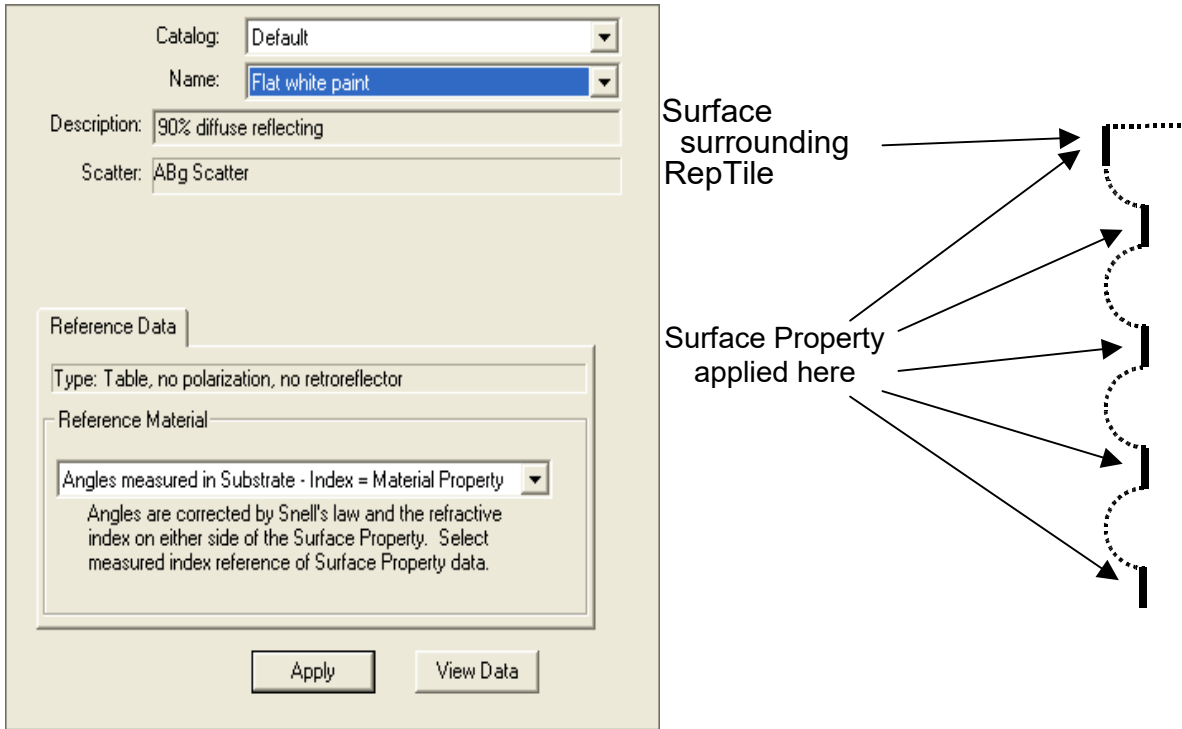

FIGURE 4.32 - Applying a surface property to the underlying surface of a RepTile surface in the Apply Properties dialog. The surface property will apply to the surfaces drawn with bold lines in the schematic.

If you are interested in tracing rays that are absorbed by all regions of the RepTile surface (as shown in Figure 4.30C), then the surface property of the RepTile region (Figure 4.31) as well as the surface property of the underlying surface (Figure 4.32) should both be set to *Perfect Absorber*.

Specifying a RepTile Texture File Surface

A Texture File property is another method to apply RepTile-type Geometry to surfaces. Texture Files contain numerical data about the Features that comprise the RepTile Geometry. After you have defined a property for a RepTile Texture File, you can assign it to a surface in the same manner that you assign a standard RepTile property to a surface. For more information about defining a RepTile Texture File property, see the section titled “Texture File” on page 3.74 in Chapter 3, 'Defining Properties'.

There are a number of differences between RepTile Textures and standard RepTile Geometry:

- The data describing the Features comes from an external file that is generated by other means (e.g., CAD or spreadsheet programs),
- The Texture File must follow a prescribed data format (See “Texture File Format” on page 7.111.),
- Each Feature within the Texture File is distinct, meaning that the Features are not tiled across the selected RepTile region, but each must be specifically listed in the TextureFile (thus this file can get quite large),

- The Feature data does not have to be in any particular order, such that Feature spatial positions, size, and so forth can be variable (i.e., random) within the file,
- Multiple Features can inhabit the same RepTile Tile/Pixel,
- Features can overlap with the potential of creating complex structure on the RepTile surface,
- A Texture File can contain both Bumps and Holes,
- The ability to invert the Bump/Hole designation of each Feature with the use of the Bump/Hole Button in the RepTile Property Editor,
- The RepTile Buffers are 1×10^{-10} mm, and
- Texture File Features overlapping the RepTile boundary are ignored.

Otherwise, the defining, applying, and ray tracing of RepTile Texture Files is accomplished the same way as other RepTile Properties. The current capabilities for the Feature Geometry Types that can be contained within a RepTile Texture File are shown in Table 3.13 on page 3.55.

Figure 4.33 shows the **Apply Properties|RepTile** dialog for the case where a Texture File is applied to the surface. Note that the steps to define this actual property (TextureExample) are shown in “RepTile Geometries” on page 3.54. You can set the following parameters:

- **Catalog:** the catalog in which the RepTile Texture property is located,
- **Name:** the name of the RepTile Texture property within the selected Catalog,
- **Boundary:** the shape of the boundary, either Rectangular or Circular, in which the Features from the RepTile Texture will be located,
- **Width and Height:** the width and height in model units for the boundary,
- **Depth:** the depth in model units for the selected boundary. Note that the depth coordinate varies dependent the on Bump selection (see combo box at the bottom of Figure 4.33). Detailed information is supplied in “Base Plane Designation for Textured RepTile” on page 4.52,
- **Boundary Center:** the boundary center in model units in global coordinates,
- **Texture Origin:** offset of the Features within the Texture File respect to the Boundary Center,
- **Texture Up:** the vector designating the local up vector for the Features,
- **Boundary Up:** the vector designating the local up vector for the boundary,
- **Pixel Height and Width:** the Tile/Pixel size in the two transverse coordinates. The default values arise from those entered originally through the RepTile Property Editor. Designation here indicates the Tile/Pixel Width for the current surface implementation. It does not overwrite the stored property data, and
- **Bump designation combo box:** denotes the orientation of the Features (see “Bump Designation for Textured RepTile” on page 4.48)
 1. Bump: all Features treated as bumps,
 2. Hole: all Features treated as holes,
 3. Mixed: Features as designated in RepTile Texture file, and
 4. Inverted: Features are inverted as designated in RepTile Texture file.

The dialog box is titled 'Apply Properties: RepTile' and is used for configuring a 'Texture File' property. It is organized into three main sections:

- Property Data:** Contains dropdown menus for 'Catalog' (set to 'Default'), 'Name' (set to 'TextureTest1'), 'Surface Catalog' (set to 'Default'), and 'Surface Name' (set to 'Perfect Absorber'). There is also a text input field for 'Texture File'.
- Boundary and Orientation:** Features a dropdown menu set to 'Rectangular'. It includes input fields for 'Width: 10', 'Height: 10', and 'Depth: 1'. Below this are four columns of coordinate inputs: 'Boundary Center', 'Texture Origin', 'Texture Up', and 'Boundary Up'. Each column has 'X', 'Y', and 'Z' inputs. For 'Boundary Center', all are 0. For 'Texture Origin', X and Z are 0, Y is 0. For 'Texture Up', X and Z are 0, Y is 1. For 'Boundary Up', X and Z are 0, Y is 1.
- Pixel Dimensions:** Includes input fields for 'Width: 1' and 'Height: 1', and a dropdown menu set to 'Bump'.

At the bottom of the dialog are three buttons: 'Export', 'Apply', and 'View Data'.

FIGURE 4.33 - Depiction of the Apply Properties: RepTile dialog for a property of Texture File type.

Bump Designation for Textured RepTile

You can update the bump and hole designation of the features in a Textured RepTile property. The four choices are:

- Bump [default]: all features will be interpreted as bumps, which overrides the designations within the Texture File,
- Hole: all features will be interpreted as holes, which overrides the designations within the Texture File,
- Mixed: the bump/hole designations are as in the Texture File, and
- Inverted: switches the bump/hole Texture File designations such that bumps are now holes and holes are now bumps.

You set the default property designation through the RepTile Property Editor, but you can update it through the RepTile Apply Properties dialog tab (Figure 4.34). If it is changed via the Apply Properties dialog, it does not change the RepTile property located and viewed within the Property Database file. It only changes the property locally (i.e., within the model).

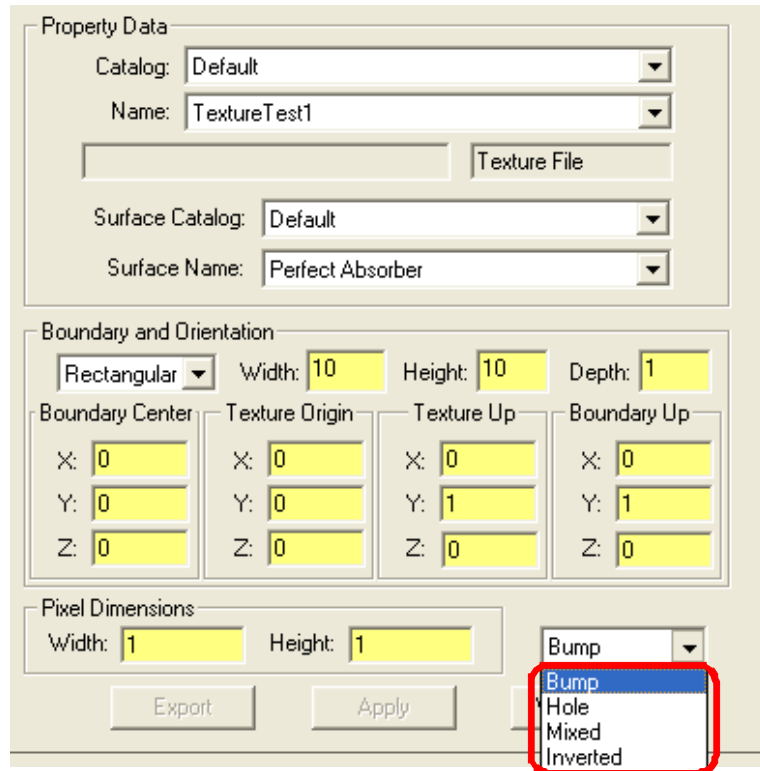

FIGURE 4.34 - Apply Properties RepTile showing a combo box (circled in red) that allows you to set the feature orientation for this application of the property.

As an example, a Texture File with the following characteristics is applied to a plane:

- Mixed bumps and holes, and
- All of the geometry types as listed in Table 3.

A series of figures displays the results of changing the bump designation via the combo box of Figure 4.34. The figures are:

- Figure 4.35: Mixed features, so the orientations are as specified in the Texture File,
- Figure 4.36: Bump features, so all features are treated as bumps,
- Figure 4.37: Hole features, so all features are treated as holes, and
- Figure 4.38: Inverted features, so the orientations are inverted as specified in the Texture File.

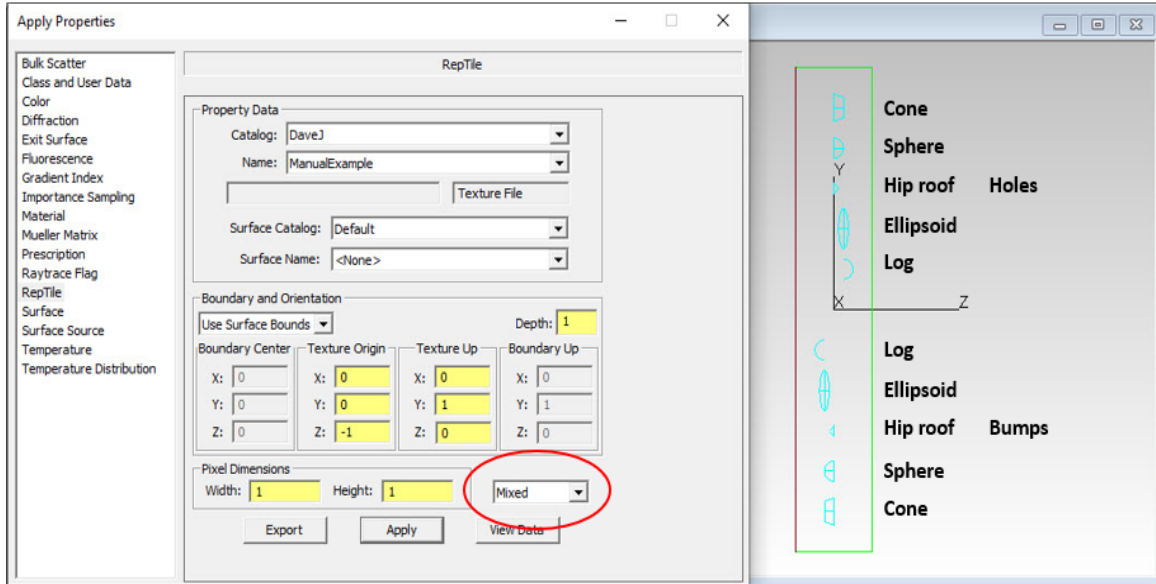

FIGURE 4.35 - Textured RepTile visualization showing the Mixed orientation for a RepTile property that originally contains Holes and Bumps.

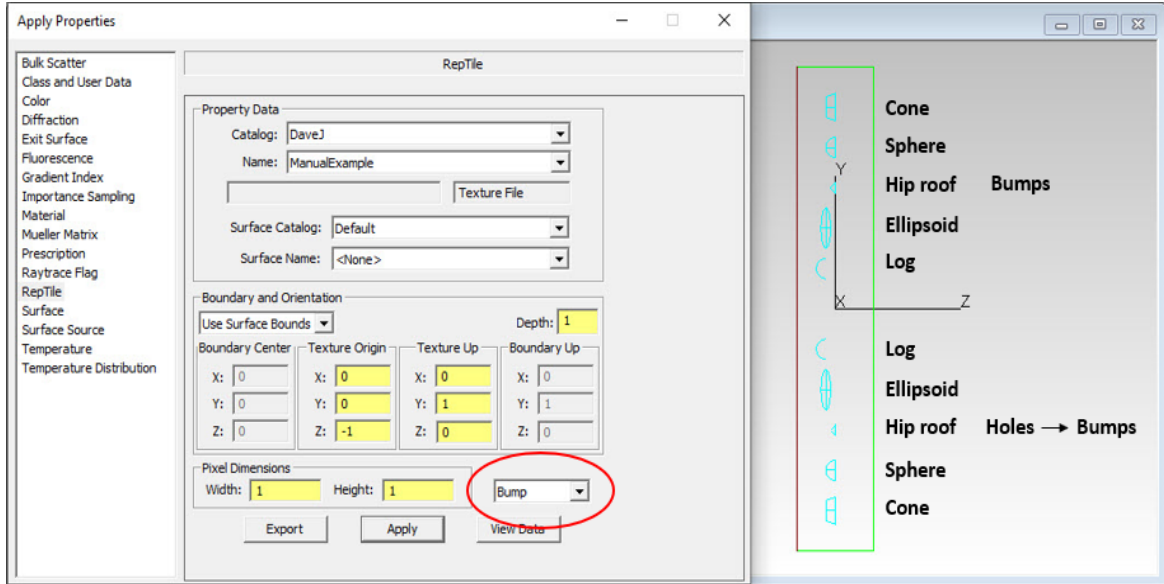

FIGURE 4.36 - Textured RepTile visualization showing the Bump orientation for a RepTile property that originally contains Holes and Bumps.

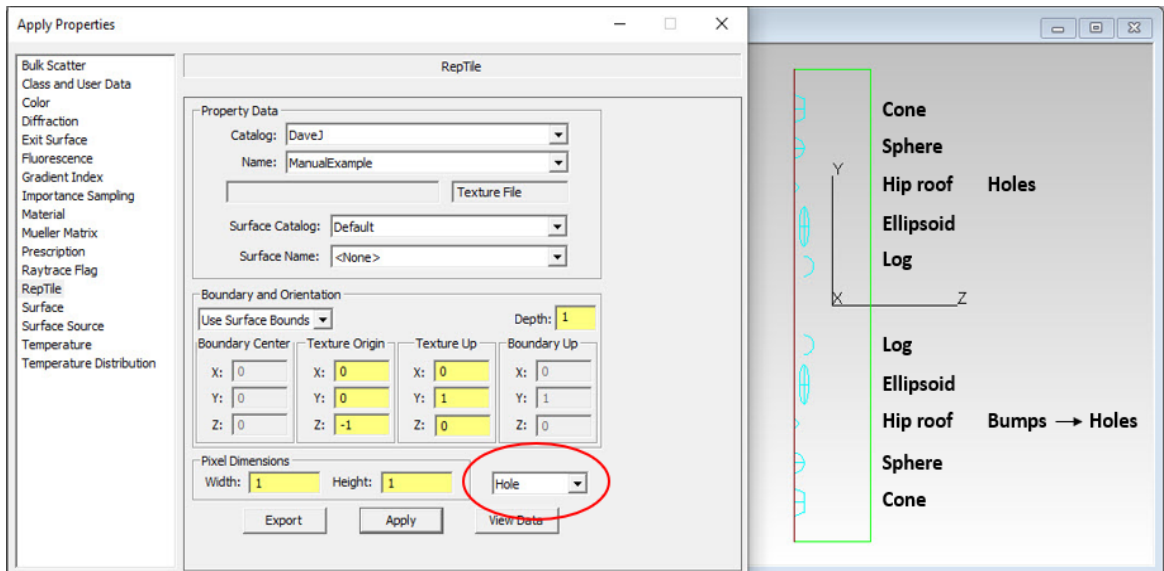

FIGURE 4.37 - Textured RepTile visualization showing the Hole orientation for a RepTile property that originally contains Holes and Bumps.

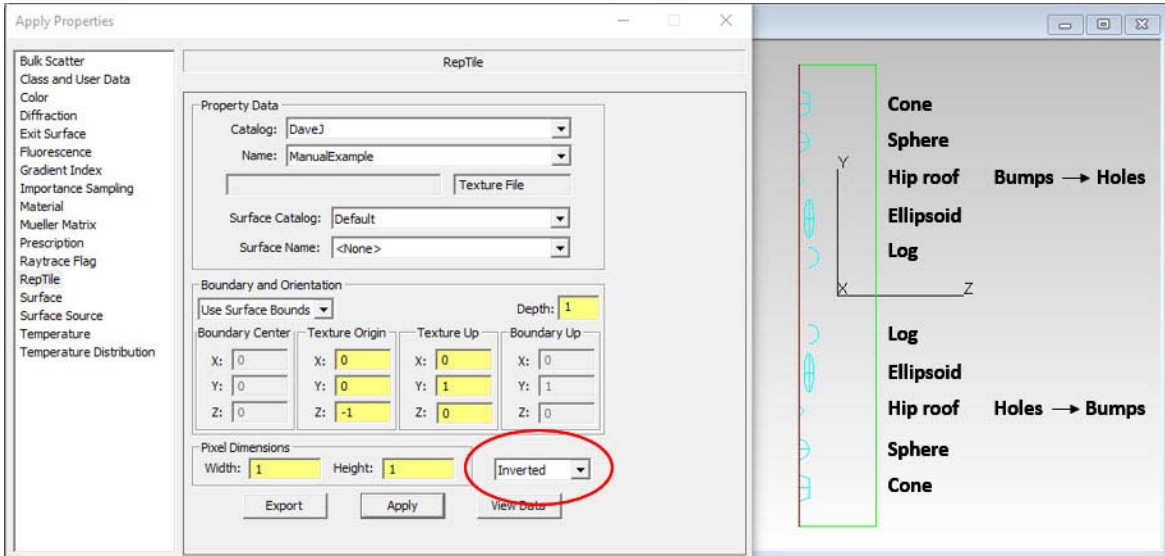

FIGURE 4.38 - Textured RepTile visualization showing the Inverted orientation for a RepTile property that originally contains Holes and Bumps.

Base Plane Designation for Textured RepTile

Textured RepTile can handle Texture Files that include both holes and bumps over the extent of the applied surface property. For a Textured RepTile that contains both holes and bumps the thickness of the RepTile volume is twice the depth/height value. The Features radiate from the base plane that is located at a distance of the depth/height below the applied surface of the object. Additionally, there is a potential danger in this increase in functionality since one can overlap the Features in a Texture pattern. Overlapping features will cause:

- Strange geometry, especially when a bump overlaps a hole.
- Ray-trace errors.

We do not recommend having overlapping bumps and holes.

All of the features in a Texture File should be contained in the volume of the object to which the Texture RepTile Property is applied. This is not an issue for the standard Bump and Hole feature orientations, but it is for Mixed or Inverted Textured RepTile properties (see below). For the Mixed and Inverted Textured RepTile orientations, the overall thickness of the RepTile volume is twice that of the depth/height value. For these two orientations, the Features radiate from the base plane which is located at a depth/height below the applied surface of the object. Thus, for the Mixed and Inverted orientations you must make the overall thickness of the object big enough to allow for this increased thickness in the RepTile volume. Table 4.8 describes the location of the base/height/depth plane(s) to which the Features are referenced. Figure 4.39 shows a graphical representation of these various planes.

TABLE 4.8. Descriptions Height/Depth value and the surface to which the RepTile Property is applied for the Bump, Hole, Mixed, and Inverted Orientations (see the Section User-Defined Bumps and Holes). See Fig. 23 for a picture.

Feature Orientation	Applied Surface of Object	Height/Depth Plane
Bump	Upper extent to applied RepTile Property	Base Plane
Hole	Base Plane	Lower extent to applied RepTile Property
Mixed	Upper extent to applied RepTile Property	Base Plane
Inverted	Upper extent to applied RepTile Property	Base Plane

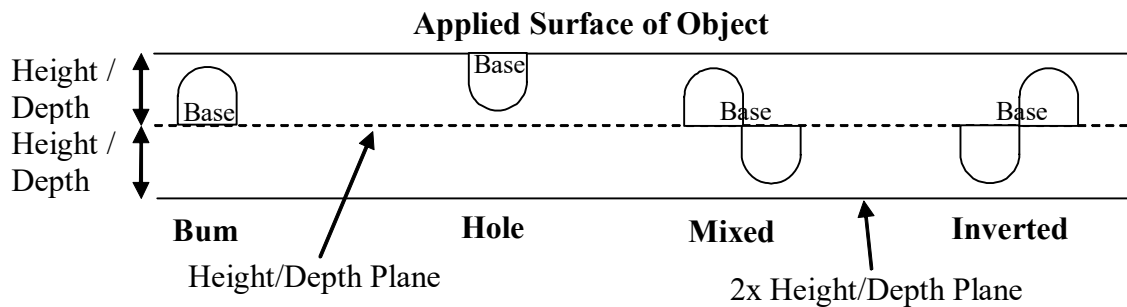

FIGURE 4.39 - Graphical representation of the planes that define the configuration of the Features that comprise a Textured RepTile.

Temperature Distribution

A temperature distribution property allows for non-uniform temperature distributions over a surface. It can be reached via the *Temperature Distribution* page in the **Define|Apply Properties** dialog box. There are several types of temperature distribution the can be applied to the following surface types:

Plane

- Type 0 - rectangular (x,y) tabular grid of temperature values
- Type 1 - rectangular (x,y) 2D polynomial
- Type 2 - circular (r,?) tabular grid of temperature values
- Type 3 - circular (r,?) 2D polynomial

Cylinder

- Type 4 - cylindrical (z,?) tabular grid of temperature values
- Type 5 - cylindrical (z,?) 2D polynomial

The distribution information is stored in an ASCII file, and can be defined by:

- a two-dimensional array of points along the surface with bilinear interpolation between the given points.
- a polynomial expression, up to fifth order, with user-defined coefficients.

You can enter the origin, dimensions and Local X Axis of the distribution in the bottom part of the dialog. If the plane or cylinder has simple boundaries then they can optionally be used for the boundary and orientation of the distribution. A simple boundary for a plane is either a rectangle or a circle. A simple boundary for a cylinder is a frustum, i.e. a portion of the cylinder bounded by two planes perpendicular to the axis of the cylinder.

If the distribution does not cover the entire surface, the temperature applied using the Temperature property will be used for regions of the surface outside the distribution boundary. See “Temperature” on page 4.36.

The distribution information stored in the ASCII file can be defined by: a two dimensional array of points along the surface, with bilinear interpolation between the given points; a polynomial expression, up to the fifth order, with user-defined coefficients. See “Non-Uniform Temperature Distributions” on page 7.68.

The temperature distribution, when used with a Surface Property or a Surface Source Property that has several temperatures defined, enables the property to vary with temperature spatially across the surface. During a ray-trace, the temperature is first evaluated by interpolating the temperature distribution for the ray intersection point, and then this temperature is used to interpolate Property. This can also be used, indirectly, as a way to make TracePro use a spatially-varying property. If the temperature is not important in the current analysis, it can be effectively used as a parameter to spatially vary the property.

Applying a temperature distribution

To apply a temperature distribution to a plane or cylinder:

- Define the appropriate distribution data in a text file in the correct format.
- Select the surface to which you will apply the distribution.
- Select **Define > Apply Properties > Temperature Distribution**.
- Type in, or browse to, the file containing the distribution you wish to apply.
- Enter boundary data.
- If the surface has a simple boundary that matches the distribution, you will be offered a checkbox to use the surface boundary as the distribution boundary.
- Click Apply.

Introduction to Ray Tracing

Ray Tracing is the means by which TracePro simulates the distribution of flux throughout a model in analysis mode and at selected surfaces in simulation mode. This chapter contains the logic behind ray tracing in TracePro and the techniques you can use to enhance your raytrace.

How your rays interact with your model is partly determined by your model itself (the geometrical details of the objects you created and the properties you applied), and partly determined by how you control the rays being launched into your model. There are three basic methods of defining rays: *Grid Sources*, *File Sources* and *Surface Sources*.

Combining Sources

Sources are defined as *Grid*, *Surface* and *File*. Grid Sources are defined as virtual windows to a distant source with rays emanating from the window. Surface Sources are applied as a property to an object's surface. File Sources are comprised of external ray data read by TracePro during the ray trace. Multiple types of each source can be defined and combinations of the three can be made to control the flux necessary to conduct a desired ray trace simulation.

Managing Sources with the System Tree

Each of the source types can be defined from the **Define** menu or by Right-Clicking in the Source tab of the System tree.

The Source tab in the System Tree (see page 1.6) acts as a central repository for all of the sources contained in the model. Each source is displayed as a node in a Source Tree. Expanding a node displays the various sources of each type and further displays the relevant data for each source. Each source node is preceded by a Green Check or Red X. Clicking on this flag will add or remove the source from the list of sources to trace.

Selecting a grid, surface or file source in the Source tab of the System Tree will cause it to be displayed in the Model Window. The displayed color of each source can be set when defining the source.

As an example, Figure 5.2 shows a model with the Source tab active in the System Tree. The Grid Source named "Grid Source 1" is selected and the boundary of the source is displayed in the Model Window. The Model also has a Surface Source defined but no File Sources. Both the Grid and Surface sources are enabled for raytracing since the Green Check is set.

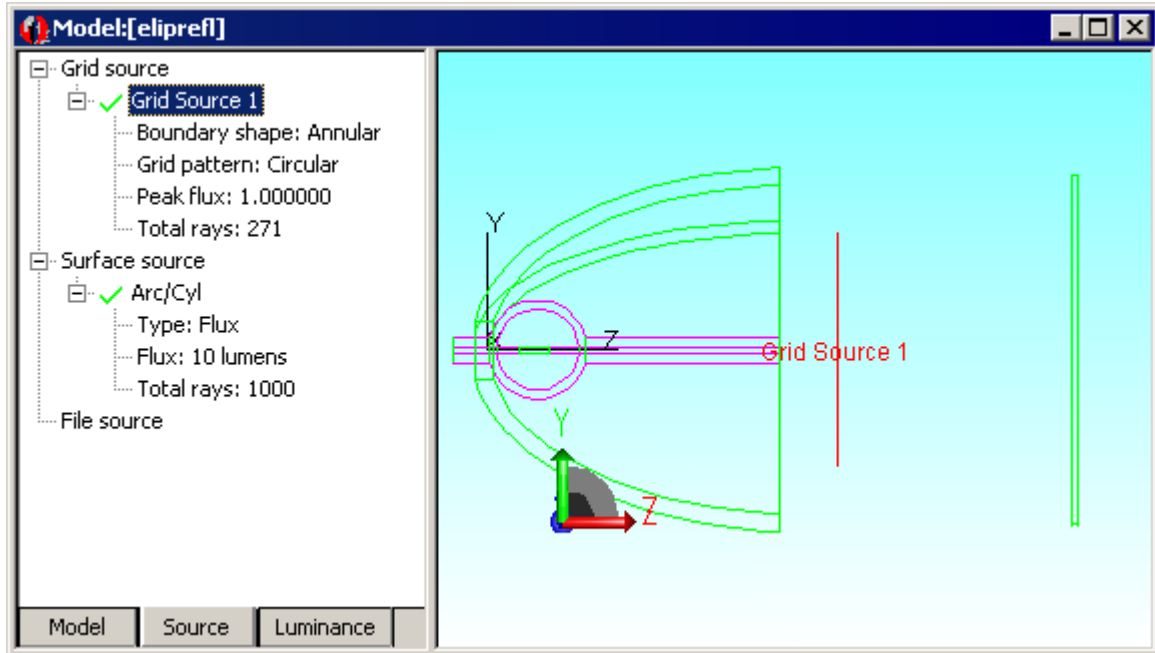

FIGURE 5.1 - Source Tab displayed in the System Tree.

Managing Sources with the Source/Wavelength Selector

The Source/Wavelength Selector is available from the **Raytrace** menu. It displays a summary of all the sources and wavelengths in the model, and allows you to turn off and on individual sources and wavelengths. To turn off a wavelength or source, click on the green check-mark to change it to a red x. Figure 5.2 shows the Source/Wavelength Selector with two sources, one Grid Source and one Surface Source. The Grid Source has five wavelengths, and the Surface Source has two wavelengths. You can sort on Source Type, Source Name, or Wavelength by clicking on a column heading. Clicking on the heading a second time sorts the column in reverse order.

Source Type	Source Name	Include Source?	Wavelength Description	Wavelength (µm)	Include Wavelength?
Grid Source	Grid Source 1	✓	Discrete Wavelength with weight of 1	0.45	✓
Grid Source	Grid Source 1	✓	Discrete Wavelength with weight of 1	0.48	✓
Grid Source	Grid Source 1	✓	Discrete Wavelength with weight of 1	0.51	✓
Grid Source	Grid Source 1	✓	Discrete Wavelength with weight of 1	0.53	✓
Grid Source	Grid Source 1	✓	Discrete Wavelength with weight of 1	0.55	✓
Surface Source	Sphere 1/Surface 0	✓	Discrete Wavelength with weight of 1	0.5	✓
Surface Source	Sphere 1/Surface 0	✓	Discrete Wavelength with weight of 1	0.6	✓

FIGURE 5.2 - Source/Wavelength Selector with two sources and seven wavelengths.

Defining Sources

This section will discuss how each source type is defined. The following section will explain how to initiate a ray trace within TracePro. The final section will go over the various options used to control the raytrace performance.

Grid Sources

For a Grid Source, you specify the spatial and angular distribution of rays in a regular or random grid. You also specify the number of rays to be traced and the peak flux. TracePro launches a grid of rays from this imaginary plane.

Upon initial startup a default Grid Source is defined within TracePro. The default entries in dialog box can be changed by entering the desired data, then clicking the Set Defaults button. The entered data is stored in the TracePro Defaults file. These default values for a Grid Source will be used whenever a new Grid Source is defined, including when a new model is created and the dialog is opened for the first time. This data is also saved when the Model is saved as an OML file. See "User Defaults" on page 1.11 for more details.

The first tab, Grid Setup, provides a set of parameters for defining a grid and is summarized in Table 5.1. The Grid parameters establish the size, pattern and location of the grid. Initially, you can think of the grid as a sampling of rays from an infinitely distant source where all rays are collimated or parallel to each other.

The Grid plane defines a window into the rays passing through boundary and perpendicular to the plane.

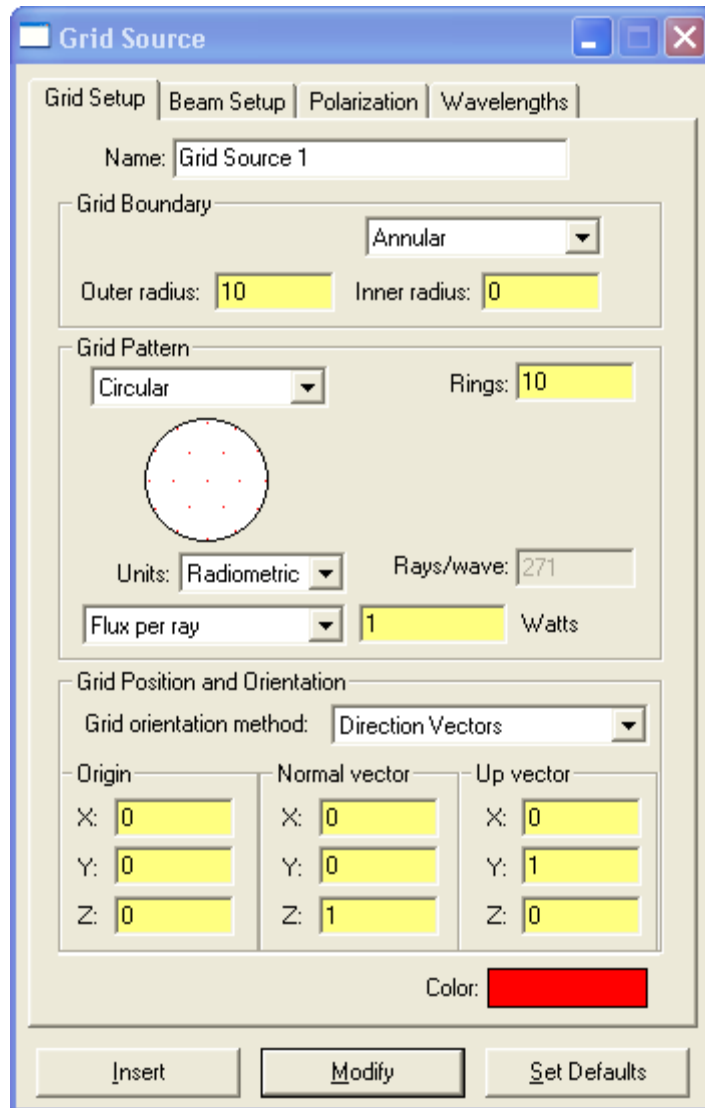

FIGURE 5.3 - From the Define menu, the Grid Source dialog box

TABLE 5.1. Grid Source Options - Grid Setup

Grid Setup tab	
Attribute	Value(s)
Name	The name of the grid source as displayed in the Source pane of the System Tree. To make a new grid source, type the name of the source and click <i>Insert</i> . To edit an existing Grid Source, select it in the Source Tree. To rename a source, once you have selected it, type the new name and click <i>Modify</i> .
Grid Boundary	Annular Rectangular
Grid Dimensions	Inner & outer radius (Annular) Y half-height & X half-width (Rectangular)
Grid Pattern	Rectangular Circular Cross Dithered rectangular Random Checkerboard
Grid density	Number of rings (circular pattern), OR X points & Y points (rectangular, cross, or dithered grid pattern), OR Not applicable (random grid pattern), OR X major points, Y major points, X minor points & Y minor points (checkerboard)
Number of rays to trace	Calculated rays per wavelength (rectangular, circular, cross, dithered grid pattern, or checkerboard), OR Total rays for all wavelengths (random grid pattern)
Units	Units for the flux to be emitted by the source, either Radiometric (Watt or Watt/m ²) or Photometric (lumen or lux).
Flux per ray, Total flux, or Total Irradiance	User defined
Center coordinates of grid	x, y, z coordinates of origin
Orientation of grid	x, y, z Normal and Up vectors OR x, y, z Euler rotation angles
Color	Opens a color palette to choose the displayed color of the source in the Model Window

Table 5.2 lists the Beam options of a Grid Source. The Beam options alter the spatial and angular profiles of the grid.

TABLE 5.2. Grid Source Options - Beam Setup

Beam Setup tab	
Attribute	Value(s)
Spatial profile of beam	Uniform Gaussian
Spatial weighting of beam	uniform flux & weighted position OR uniform position & weighted flux (Gaussian)
Spatial Dimensions of Beam (Gaussian only)	x waist $1/e^2$ radius y waist $1/e^2$ radius
Angular profile of beam	Uniform Gaussian Lambertian Solar
Angular weighting of beam	Uniform flux & weighted angle OR Uniform angle & weighted flux (Random grid and angularly non-uniform beam only)
Angular Dimensions of Beam	radius OR x half-angle & y half-angle
Orientation of beam	set perpendicular to grid OR direction vectors OR Euler angles OR Converge to a point OR Diverge from a point

Table 5.3 lists the Wavelength data of a Grid Source. You can enter wavelengths and weights, while flux and number of rays are determined by entries on the Grid Setup tab.

TABLE 5.3. Grid Source Options - Wavelength

Wavelength tab	
Attribute	Value(s)
Wavelength	Discrete wavelength(s) in μm . Add wavelengths by typing the wavelength, and clicking Add or typing the Enter key. Delete wavelength(s) by selecting them in the table and clicking Delete.
Weight	Relative weighting factor to be applied to the flux for each wavelength.
Flux	Flux to emitted for this wavelength, a calculated value. For Total Flux or Total Irradiance sources, the flux for each wavelength will be adjusted so that they add up to the total flux as determined by the Flux or Irradiance entry on the Grid Setup tab.
#Rays	Calculated, depending on choices on Grid Setup tab. For Random grid pattern, the number of rays for each wavelength will be adjusted so that the flux per ray for each wavelength is approximately the same.

The Polarization tab provides a means to set the initial Polarization state of the rays emitted from the Grid plane. The polarization options are listed in Table 5.4.

TABLE 5.4. Grid Source Options - Polarization Setup

Standard Expert

Polarization tab	
Attribute	Value(s)
Polarization state	Unpolarized, linear, circular, or custom
Degree of Polarization	$0 < \text{degree} \leq 1$
Custom Polarization	Method, Handedness, Ratio, Orientation
Normalized Stokes Vector	Display only

Once you have set the parameters, click the *Trace This* button and the raytrace begins. See “Standard (Forward) Raytrace” on page 5.36

Setting Up the Grid

Grid Boundary

The grid boundary specifies the shape and dimensions of the boundary within which a planar grid of rays is generated. Rays are generated according to the grid pattern. Ray starting points that are outside the grid boundary are truncated, thus,

the total number of rays actually traced may not agree with the total number provided in the dialog box. Grid patterns and boundaries can be mixed and matched.

Shape

An annular grid boundary means that an annulus is defined with radii given by the grid dimensions. All ray starting points are required to lie within the annulus.

For example, if a rectangular *Grid Pattern* is chosen with an annular grid boundary, rays are started in a square grid with sides equal to the outer diameter of the annulus. Points outside the annulus—in the hole of the annulus or in the corners of the square—are eliminated.

If a rectangular grid boundary is used with a circular grid pattern, then the diagonal dimension of the rectangular boundary is used as the diameter of the circular grid. Points in the circle that lie outside the rectangle are truncated.

If an annular grid boundary is used with a circular grid pattern, rays in the hole of the annulus are truncated.

If a random grid is chosen, points are randomly selected within the boundary (either annular or rectangular).

Dimensions

- Outer Radius or Y Half-Height of Grid

Outer radius refers to the outer radius of the annular boundary. The y half-height is the half-height of the rectangular grid boundary in the direction of the Up vector or local y-axis of the grid.

- Inner Radius or X Half-Width of Grid

Inner radius refers to the inner radius of the annular boundary. Inner radius is the half-width of the rectangular grid boundary in the local x direction of the grid.

Grid Pattern

Regular and dithered grids are defined by an array of cells. Once the grid pattern is chosen, the area surrounded by the grid boundary is divided into an array of cells, each with equal area. Then one ray is started from within each cell. For circular, rectangular, and cross grids, each ray is started from the geometric center of each cell. In a dithered rectangular grid, for each cell a point is chosen at random within the cell, and a ray is started from that point.

For a random grid, the grid boundary is not subdivided and each ray is started from a totally random location within the grid boundary.

Circular

In a circular grid pattern, rays are started in rings. The first ring is simply a point at the center of the circle, and the second ring consists of six rays equally spaced around a circle. Each successive ring has an additional six rays. The radii of the rings are set so that each ray represents an equal area.

If you choose a number of rings equal to n , the number of rays N that are generated is:

$$N = 3n(n - 1) + 1 \quad (5.1)$$

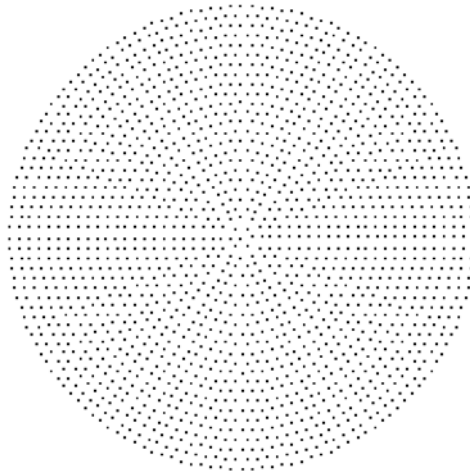

FIGURE 5.4 - Example of circular grid with 25 rings resulting in 1801 rays

Rectangular

In a rectangular grid pattern, rays start in a rectangular pattern, spaced in equal increments along each of the local x and y-axes. To determine the starting points for the rays, the boundary region is divided into rectangular cells.

For a rectangular boundary, the rectangle is divided into $N_x \times N_y$ cells, where N_x and N_y are the number of points in the local or grid x and y directions, respectively. The local x and y directions are determined by the Grid Orientation at the bottom of the dialog box.

For an annular region, a square with side equal to the diameter of the outer circle is used for the boundary region. Once the cells are determined, one ray is started from the center of each cell. That results in a regularly spaced grid of rays.

The spacing of the ray starting points need not be the same in the x and y directions. In other words, the cells for determining the ray starting points need not be square, but are rectangular in general. The grid spacing (or cell aspect ratio) is determined by the aspect ratio of the boundary and the values of N_x and N_y .

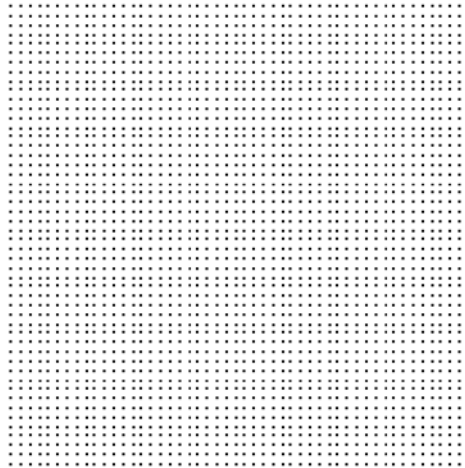

FIGURE 5.5 - Example of rectangular grid with $N_x = 50$ and $N_y = 50$ and a square boundary, resulting in a square pattern with 2500 rays.

Dithered

Dithering is a process by which the rays in a rectangular grid are altered slightly to introduce randomness in their starting positions—a compromise between a rectangular grid and a random grid. Dithering breaks up pattern noise that occurs with a rectangular grid while avoiding holes and clumps that occur in a random grid.

The dithering is accomplished in TracePro by first defining a rectangular array of cells as for the rectangular ray grid, then choosing a ray starting point randomly within each cell.

The cells for determining the ray starting points for a dithered grid need not be square, but are rectangular in general. The cell aspect ratio is determined by the aspect ratio of the boundary and the values of N_x and N_y .

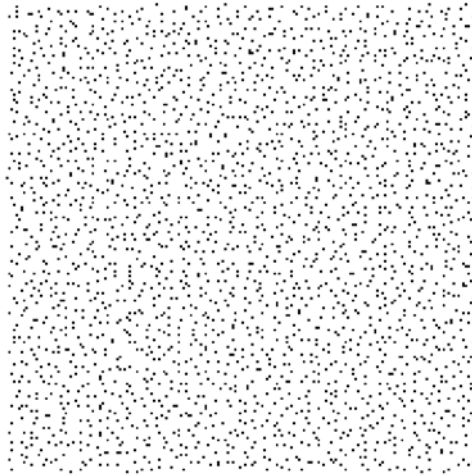

FIGURE 5.6 - Example of a dithered rectangular grid with $N_x = 50$ and $N_y = 50$ and a square boundary. Compare this with the figures for a rectangular grid (Figure 5.5) and for a random grid (Figure 5.8).

Cross

The cross grid pattern lets you generate two lines of rays, one in the horizontal direction, the other in the vertical direction. The number of rays in each direction is always an odd number, so that there is always a ray at the center of the pattern. If you enter an even number, one will be added to it to obtain an odd number before the rays are generated. The ray starting points are determined by dividing the boundary region into a grid of rectangular cells numbering $N_x \times N_y$.

The cells for determining the ray starting points need not be square, but are rectangular in general. The cell aspect ratio is determined by the aspect ratio of the boundary and the values of N_x and N_y .

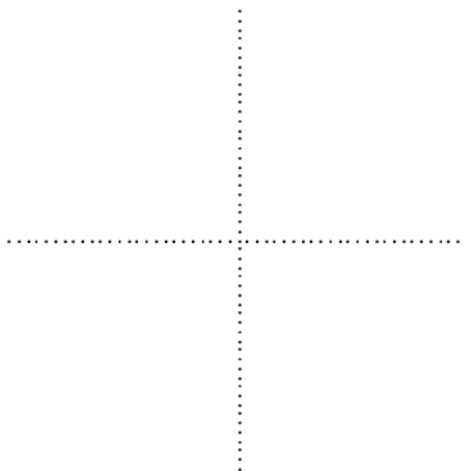

FIGURE 5.7 - Example of Cross grid with $N_x = 50$ and $N_y = 50$ resulting in a pattern of 101 rays.

Random grid

In a random grid, points are selected randomly within the grid boundary. For a rectangular boundary, points are selected at random within the rectangle, and for

an annular boundary, they are selected randomly within the annulus. Instead of choosing the N_x and N_y values or a number of rings, you directly enter the total number of rays to be traced.

A random grid is the purest form of Monte Carlo simulation, though it is not necessarily the best. As can be seen in Figure 5.8, especially when contrasted with the dithered random grid of Figure 5.6, the random distribution suffers from voids and clumps in the ray distribution. This is bothersome if your model contains a small design detail that needs a good sampling of rays (that is, not over- or under-sampling)

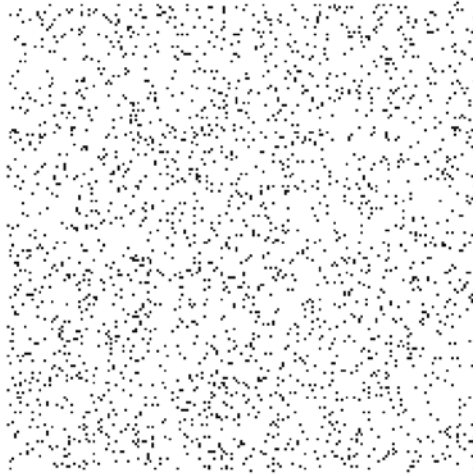

FIGURE 5.8 - Example random grid pattern with 2500 rays and a square boundary. Compare this with the figures for a rectangular grid and for a dithered rectangular grid (above).

Checkerboard

This pattern includes major and minor increments for the ray positions within the pattern. Between each major point additional rays will be traced for each set of minor points. The new dialog is shown in Figure 5.9.

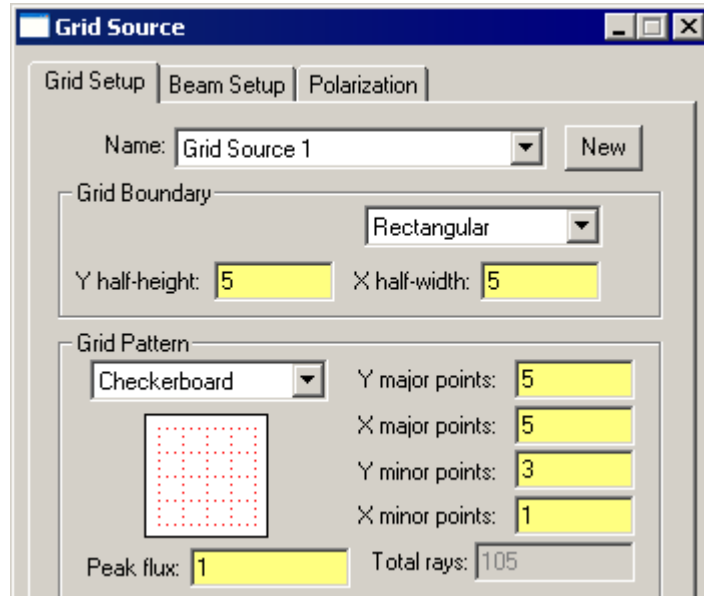

FIGURE 5.9 - Grid Source with checkerboard pattern

The output from the above ray grid is shown as an irradiance plot in Figure 5.10.

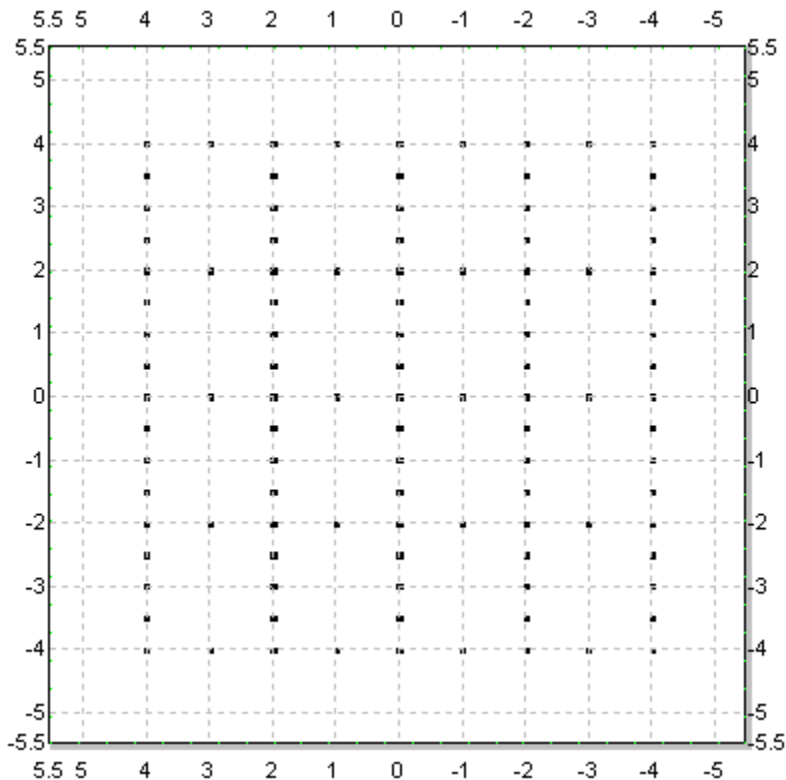

FIGURE 5.10 - Irradiance plot showing checkerboard grid pattern

Grid Density: Points/Rings

Number of Rings/Y Grid Points

This is the total number of grid points along the radius (i.e. the number of rings) for a circular grid, or across the entire grid in the y direction for a rectangular or dithered rectangular grid. Specifying one for this value in a rectangular grid causes one row of rays to be generated. Specifying one for this value in a circular grid causes one ray to be generated at the center of the grid.

Number of X Grid Points

This is the total number of grid points across the entire grid in the x direction for a rectangular or dithered rectangular grid. Specifying one for this value causes one column of rays to be generated in a rectangular grid.

Total rays

When the *Grid Pattern* is set to *Random*, enter the total number of rays to be emitted for all wavelengths here. For other Grid Patterns, this is a calculated value and cannot be changed.

Flux

You can select Flux per Ray, Total Flux, or Total Irradiance. The Flux per Ray is the average flux per ray. It is a constant flux value for a uniform beam, and varies for a non-uniform beam. For a uniform beam the ray flux of each starting ray is equal to this number. For a non-uniform beam, each ray may have a different flux, but the average flux for all rays is approximately equal to this number.

The Total Flux is the total flux, in the selected units, to be emitted over all wavelengths. Thus the sum of the flux over all wavelengths will be equal to this number.

The Total Irradiance is the total irradiance (illuminance), in the selected units, to be emitted over all wavelengths. Thus the sum of the irradiance over all wavelengths will be equal to this number.

Origin of Grid

These are simply the x, y, and z coordinates of the center of the grid in the coordinate system of the model.

Orientation of Grid

The orientation of the grid is specified either by normal and up vectors or rotation angles.

Normal and Up Vectors

The normal vector specifies the direction that is perpendicular to the imaginary plane defining the grid. The up vector specifies the direction along which the local y-axis points as well as the direction along which the y dimension of the grid pattern and boundary are measured. You do not need to make the up vector perpendicular to the normal vector, and the vectors do not need to be unit vectors. For example, suppose you wish to emit rays from a plane at a 45 degree angle to

the y and z-axes, with the up direction lying in the y-z plane. You could do this by entering, for example, the vectors shown in Table 5.5.

TABLE 5.5. Normal Vector with a 45 degree angle from both the y and z-axes.

Normal Vector		Up Vector	
X	0	X	0
Y	1	Y	1
Z	1	Z	0

TracePro normalizes the normal vector $(0, 1/\sqrt{2}, 1/\sqrt{2})$, then the up vector is rotated to be perpendicular to the normal vector but still in the plane formed by the original normal vector and up vector. After rotation, the up vector is $(0, 1/\sqrt{2}, -1/\sqrt{2})$. For more details see “Normal and Up Vectors” on page 1.14.

Euler Angles

The Euler angles specify rotation angles about the coordinate axes for orienting the grid. For rotation angles equal to zero, the grid has its normal in the global +z direction, the y dimensions of the boundary and grid are along the y-axis, and the x dimensions are along the x-axis. The three rotation angles allow you to modify the orientation of the grid by successive rotations about the x, y, and z-axes.

You can choose to enter the angles in radians or degrees. To get a grid that is oriented as in the previous example, you would enter an x Euler angle in degrees of -45° , with y and z equal to zero. Rotations obey the right-hand rule.

Beam Setup

Spatial Profile of Beam

The spatial shape of the beam can be either uniform (flat-topped) or Gaussian. If a Gaussian profile is chosen, you can enter the x and y waist radii of the beam to make an elliptical beam. To make a Gaussian with circular symmetry, enter the same number for both the x and y values. The x and y waist radii are the distances from the peak of the beam to the $1/e^2$ value of the beam in each direction. The orientation of the elliptical Gaussian is determined by the *Grid Position and Orientation* values on the *Grid Setup* tab. The y value is measured along the Up vector or the local y-axis of the grid, and the x value is measured along the local x-axis of the grid, i.e. perpendicular to the local y-z plane.

If a Gaussian beam is chosen, it is truncated by the grid boundary. Also, TracePro generates rays out to the edge of the boundary. If the grid boundary is much larger than the $1/e^2$ values of the beam, most of the rays are generated with absurdly low flux. If you do not wish this to happen, simply make the grid boundary smaller.

If a Gaussian beam is chosen, then a random grid is always used.

Spatial Weighting of Beam

The spatial beam shape can be:

- Uniform flux & weighted position
- Uniform position & weighted flux

Uniform flux and weighted position — Each ray starts with a flux equal to the peak flux, but the starting position of each ray is chosen by using the distribution function. For a Gaussian beam, more rays will be started at the peak of the grid than near the low-flux regions, with the aggregate flux profile being the chosen functional distribution in shape.

Uniform position and weighted flux — The rays are distributed uniformly over the grid dimensions, but the flux of each ray is weighted by the spatial distribution function.

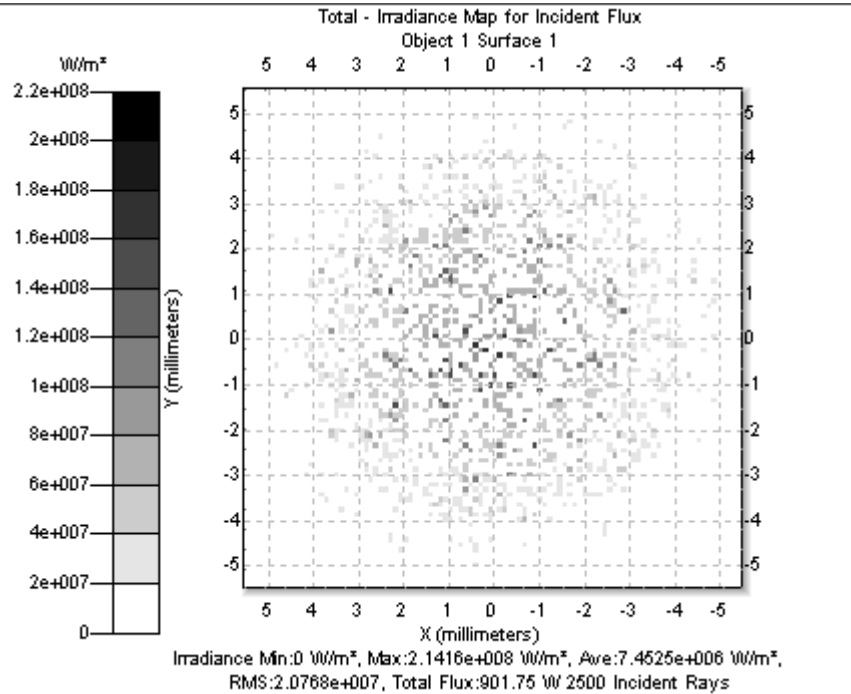

FIGURE 5.11 - Irradiance map for a circular Gaussian beam with uniform position and weighted flux. The starting points of the rays are distributed randomly, but the rays away from the peak have lower flux.

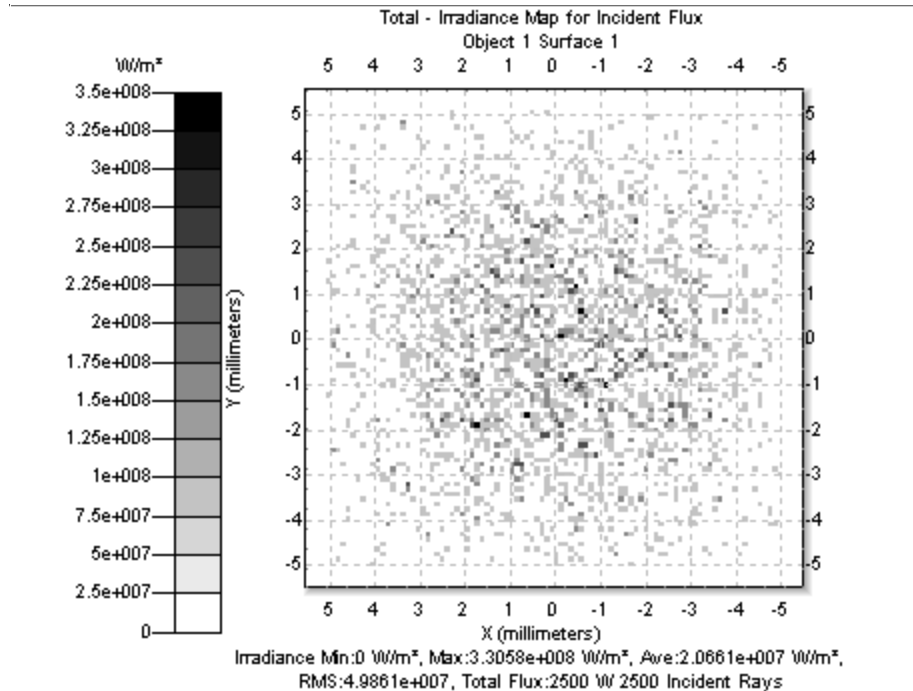

FIGURE 5.12 - Irradiance map for a circular Gaussian beam with uniform flux and weighted position. The rays all start with the same flux, but more rays are generated near the peak of the Gaussian.

Spatial Dimensions of Beam

These dimensions are meaningful only for a non-uniform spatial beam profile. For a Gaussian spatial beam profile, the x and y radii define an elliptical Gaussian beam, i.e.,

$$E = E_{\text{peak}} e^{-2(x/x_0)^2 - 2(y/y_0)^2}, \quad (5.2)$$

where x and y are the local or grid coordinate axes, E is the ray flux, E_{peak} is the peak flux and x_0 and y_0 are the elliptical $1/e^2$ radii. The grid y -axis is defined by the grid position/orientation Up Vector, and the grid z -axis is defined by the Normal Vector. The grid x axis forms a right-handed coordinate system with the other axes.

Spatial X Waist Radius of Beam

This is the radius to the $1/e^2$ value of the beam along the grid x -axis,

$$E = E_{\text{peak}} e^{-2(x/x_0)^2}, \quad (5.3)$$

where x_0 is the waist radius.

Spatial Y Waist Radius of Beam

This is the radius to the $1/e^2$ value of the beam along the grid y -axis,

$$E = E_{\text{peak}} e^{-2(y/y_0)^2}, \quad (5.4)$$

where y_0 is the waist radius.

Angular profile of beam

The angular profile of the beam can have a shape that is either uniform (i.e., forming a cone of rays), Gaussian, Lambertian or solar. The angular shape is centered on the beam direction.

A uniform beam has uniform intensity within the cone angle defining the beam, and zero outside it.

A Gaussian beam is Gaussian in profile, and the local x and y angles can be set independently to create an elliptical angular shape for the beam.

A Lambertian beam has intensity equal to,

$$I = I_0 \cos \theta, \quad (5.5)$$

where $\theta = 0$ is along the grid normal. The beam is truncated at the angular radius entered in the *Half angle R* entry.

A solar beam has angular profile equal to that measured for the sun. For this selection, TracePro ignores the entries for angular size and uses the measured angular size of the sun. The angular profile varies with the wavelength of light, so TracePro uses the wavelength currently being traced as entered in the *Raytrace Options* dialog box, *Options* tab. Data for the solar profile is taken from [Astrophysical Quantities](#), Second Edition, Chapter 9, by C.W. Allen, The Athlone Press, London, ISBN: 0387987460 (1963).

Angular Weighting of Beam

This option is used only for nonuniform angular beam shape (i.e. Gaussian, Lambertian, or solar). The beam can be either:

- Uniform flux & weighted angle
- Uniform angle & weighted flux

Uniform flux and weighted angle means each ray starts with a flux equal to the peak flux, but the starting angle of each ray is chosen weighted by the angular distribution function.

Uniform position and weighted flux means that rays are distributed uniformly, but the flux of each ray is weighted by the angular distribution function.

For a Gaussian angular distribution, TracePro places an upper limit on the angular spread to avoid generating rays that have very low flux. Rays are generated within an elliptical cone such that the minimum flux of rays generated within the cone is 10^{-20} of the peak value. Rays outside this elliptical cone, i.e. rays that would have flux less than 10^{-20} of the peak value, are not generated.

Half Angle X & Y of Beam

For a Gaussian beam, this is the half angle to the $1/e^2$ value of the beam in the local X or Y direction. The Gaussian beam has an angular profile given by

$$L = L_{\text{peak}} \cos \theta e^{-[2(\sin x / \sin \theta_x)^2 + 2(\sin y / \sin \theta_y)^2]} \quad , \quad (5.6)$$

where θ_x and θ_y are the half angles, x and y are angles from the beam direction in the grid x and y directions, and θ is defined by $\sin^2 \theta = \sin^2 x + \sin^2 y$.

Half Angle R(adius)

Half Angle R is the half angle extent of the beam for Uniform and Lambertian profiles.

Beam Orientation

The orientation of the beam can be set independently of the grid's orientation or it can be tied to the orientation of the grid. If set independently, it is specified by either:

- A normal (direction) vector and up vector (in global coordinates)
- Rotation angles (in global coordinates).

Perpendicular to Grid

With this setting, the orientation of the beam is perpendicular to the plane of the grid defined in the Grid Setup Tab.

Direction Vectors

The orientation of the beam is specified by two vectors. The normal vector points down the middle of the beam, and the up vector specifies the up or local Y direction of the beam, for Gaussian angular distributions. The default vectors are:

- Direction vector (0,0,1)
- Up vector (0,1,0)

Euler Angles

Euler rotation angles in global coordinates specify a normal vector parallel to the beam and an up vector. The normal vector starts out as the Z unit vector and the up vector as the Y unit vector. Then they are rotated by the angles specified, in the order X , Y , and Z . For example, an x rotation rotates the nominal Z unit vector about the x -axis. The resulting normal vector lies in the Y - Z plane.

Converge to/Diverge from Point

This mode defines a real point, Converge to, or a virtual point, Diverge from, which is used to aim the rays as they exit the grid. This selection provides a convenient way to define a point source, either real (Diverge from) or virtual (Converge to).

Wavelengths

Use this tab to specify the discrete wavelengths to be traced for the Grid Source. You can add a wavelength by typing the wavelength, in μm , into the text box, and clicking Add (or by pressing the Enter key). To delete wavelength(s), select them in the table and click Delete.

The columns in the wavelength table are described in Table 5.3. You can enter a relative weight for each wavelength in the Weight column, to tailor the source to

your needs. The entries in the Flux and # Rays columns are calculated based on the settings in the Grid Setup tab and the weights.

Polarization Standard Expert

TracePro uses the Stokes vector-Mueller matrix representation of polarized light. The Stokes vector represents the Polarization State of the light, and the Mueller matrix represents how an optical device interacts with light. The interaction is calculated by multiplying the Mueller matrix by the Stokes vector as a column vector.

An advantage of using Stokes vectors over other methods is that unpolarized and partially polarized light can be represented. A detailed discussion of polarized light is beyond the scope of this manual, but such information can be found in many textbooks. For example:

- E.L. O'Neill, Introduction to Statistical Optics, Dover (1992),
- E. Collett, Polarized Light, Dekker (1992),
- Shurcliff and Ballard, Polarized Light, van Nostrand (1964),
- Kliger, Lewis, and Randall, Polarized Light in Optics and Spectroscopy, Academic Press (1990)).

However, you can simulate polarized light in TracePro without knowing much about Stokes vectors and Mueller matrices. A tabulation of Mueller matrices of commonly used devices is given in the Technical Reference section. See Table 7.4 on page 7.58.

The polarization tab of the Grid Source dialog box lets you specify the initial Polarization State of rays emitted from the grid. The polarization tab has three areas. In the top area you can choose the Polarization State and degree of polarization. In the middle area you can enter the specifications for a custom polarization state. The bottom part is for information only. The Polarization State is depicted graphically and the calculated Stokes vector is also shown.

Polarization State

In order to fully specify the polarization state, you must enter:

- The polarization state, either a standard or custom one.
- The degree of polarization.
- The custom specifications, if you have chosen a custom polarization state.
- The orientation of the beam. This provides a reference direction or “Up Vector” for the polarization state.

The orientation of the beam is determined by the settings in the Grid Setup tab and the Beam Setup tab.

You can specify the Polarization State in one of three ways:

- Choose one of the standard polarization states.
- Specify a custom linear polarization state.
- Specify a custom elliptical polarization state.

Choose a standard polarization state by selecting from the drop-down list at the top of the dialog box. The standard polarization states available are:

- Unpolarized

- Horizontal Linear
- Vertical Linear
- +45 degrees Linear
- -45 degrees Linear
- Right Circular
- Left Circular

Unpolarized light

Unpolarized light has no organized polarization state. It consists of a collection of random polarization states. Unpolarized light is represented by the Stokes vector:

$$\begin{bmatrix} 1 \\ 0 \\ 0 \\ 0 \end{bmatrix}$$

You can set the polarization state to unpolarized by either choosing Unpolarized from the drop-down list, or by setting the degree of polarization equal to zero with any of the polarized states.

Partially polarized light and the degree of polarization

If you specify the Polarization State, you also specify the degree of polarization. Completely unpolarized light is specified by a degree of polarization equal to 0. Fully polarized light has a degree of polarization equal to 1. Intermediate values provide a mix of polarized light, unpolarized light, or partial polarization.

Custom Polarization

Custom linear polarization states

Selecting Custom Linear from the *Polarization State* dropdown list enables two methods to set the orientation or rotation angle of the linear polarized state. By selecting Ellipse and Handedness from the *Method* dropdown list, you set the orientation of the linear polarization. For linear polarization, handedness has no meaning and the ellipse ratio collapses to 0.0. By selecting Amplitudes and Phase from the *Method* dropdown list, you can set the x and y amplitudes. For linear polarization the phase difference is zero.

Custom elliptical polarization states

Selecting Custom Elliptical from the *Polarization State* drop-down list enables two methods to set the polarization ellipse. By selecting Ellipse and Handedness from the *Method* dropdown list, you can set the handedness, ratio and orientation of the polarization ellipse. By selecting Amplitudes and Phase from the *Method* dropdown list, you can set the X and Y amplitudes and phase difference of the polarization ellipse. The labels on the entries change dynamically depending on the method you choose for specifying the ellipse. The graphical display gives helpful feedback on the polarization state you have specified.

Surface Sources

A surface source emits rays in a prescribed angular distribution from one or more surfaces of a solid objects in the Model. Surface sources are defined as Surface Properties and are described in Chapter 4. See “Surface Source Properties” on page 4.12

Importance Sampling from Surface Sources Standard Expert

In order to increase sampling in a particular direction, you can use importance sampling with surface sources. This is analogous to importance sampling for scattered rays. The importance sampling setup that you enter for scattered light is also used for surface sources.

With importance sampling specified for a surface that is a source, emitted rays will be generated in a direction as specified by the importance sampling data. The flux of the rays is determined by the angular emission profile of the source, the solid angle subtended by the importance sampling target, and the flux or irradiance of the surface source. See “Importance Sampling” on page 4.20

File Sources

A ray file can be inserted into a TracePro model and used as a source. A ray file consists of 7 columns of tabular data, XYZ starting positions for each ray, XYZ direction vectors for each ray, and a flux.

The File Source concept provides the capability to:

1. incorporate measured source distribution data from opsira,r Radiant Zemax, or other source measurement device into a TracePro model,
2. “continue” a raytrace by using data incident on one surface to be used as a source in another raytrace or another model, and
3. create a source from either theoretical or measured data in another application (e.g. - text editor or spreadsheet).

No matter which method was used to create the ray file, the File Source is inserted into the model the same way.

Creating a Ray File from Radiant Zemax Data

Radiant Zemax, Inc. (Duvall, Washington, USA) provides measurement services and data for light sources. Lambda Research collaborates with Radiant Zemax to let you import measurement data and use it within TracePro to simulate real light sources.

To create a TracePro File Source using Radiant Imaging data, perform the following steps:

1. Start ProSource, available from Radiant Imaging.
1. Open a Radiant Zemax database file.
2. Enter output options in the Ray Generation dialog.
3. Select the TracePro output type and file name with a *.dat or *.txt extension.
4. Press Generate Rays to create the TracePro ray file.

For more information on ProSource, contact Radiant Zemax, <http://www.radiantzemax.com/>.

Creating a Ray File from an Incident Ray Table

A Ray File can be created from an Incident Ray Table in TracePro. Some examples of how this capability can be used are as follows:

- model an LED, insert a dummy object as a “target”, perform a raytrace, save the Incident Ray Table as a ray file, insert the ray file of the LED into other models. The ray file for the LED can be repeatedly inserted into several locations in the same model to create an LED array
- for performing a Stray Light Analysis on a complex optical system, a dummy object can be inserted as a “target” at any point along the optical path - the Incident Rays on the “target” can be saved as a ray file, and the ray file can be inserted into the model to be used as a source while analyzing/modifying the objects at the end of the optical path - the raytrace times can be decreased considerably when the first group of objects are omitted from the raytrace

To create the ray file:

1. select the surface in the Model Window or the System Tree
2. select **Analyse | Incident Ray Table** to view the Incident Ray Table
3. with the Incident Ray table as the active window, select **File | Save As**, choose the file format as ***.txt**, and check the box for “Export to Ray File format”

The ray file saved from the Incident Ray Table will always be saved as Radiometric units. If TracePro is set to Photometric units, the data will be converted to Radiometric units when it is saved as a ray file.

For more information on Incident Ray Tables see the section titled “Incident Ray Table” on page 6.49.

Creating a Ray File from Theoretical or Measured Data

A ray file must have the appropriate header information to be recognized by TracePro. (See the TracePro Help topic “Ray File Format” for further information) The easiest way to create a file with the proper format and header information is to make a simple TracePro model and follow the steps above to create a ray file from an Incident Ray Table. Next, open the newly created ray file in a text editor or a spreadsheet application. Delete the existing data, then Calculate, cut-and-paste, or input the theoretical or measured data for the source. Save the file as a text file.

Insert Source

To use the ray file in a TracePro model, select **Define | File Source** to open the File Source dialog box as shown in Figure 5.13. You can also open the dialog from the Source tab in the System Tree by Right-Clicking and selecting **Define | File Source**.

When the File Source dialog is opened you can create a new file source by doing the following:

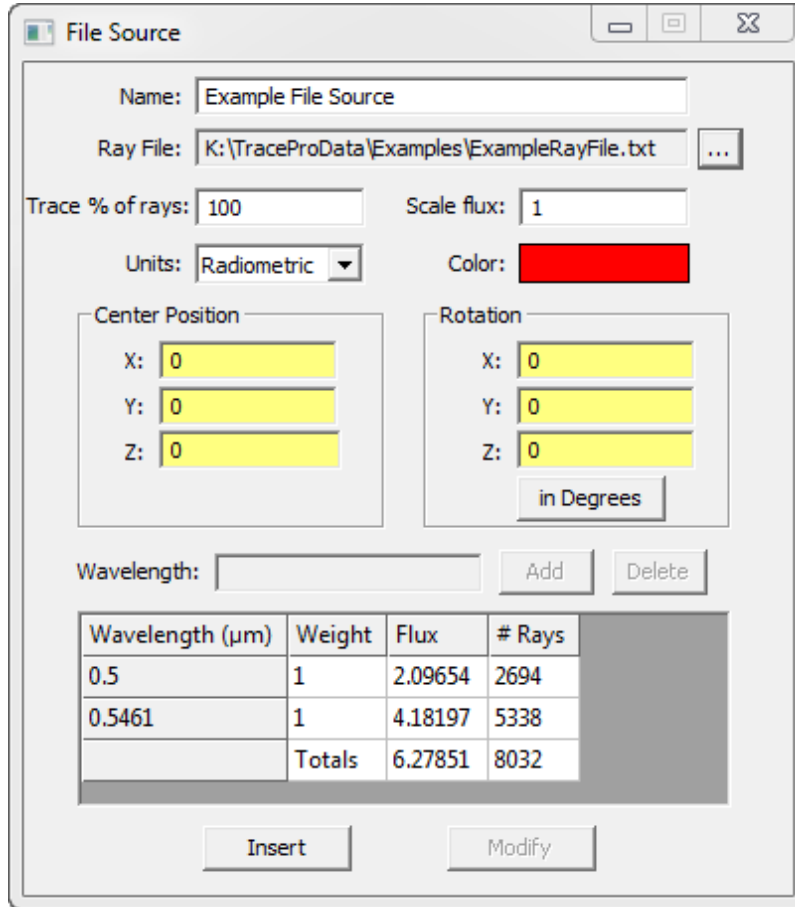

FIGURE 5.13 - File Source dialog box.



1. Enter a name to identify the source.
2. Enter the name of a **txt**, **dat**, **src** or **ray** file by either typing it into the cell or by browsing to it using the browse button on the File Source dialog box.
3. Enter the *Center Position* of the source.
4. Enter the *Rotation* angles.
5. Enter a value for Trace % of rays.
6. Enter a scale factor for the flux.
7. Select the units for the source. Do not change this setting from Radiometric in most circumstances. All TracePro ray files are in Radiometric units. If you have a ray file that was incorrectly generated and has Photometric units, i.e. ray fluxes in lumens instead of watts, this setting allows you specify that the flux values in the file are lumens instead of watts.
8. Select a color.
9. Click *Insert* to insert the source into your model.

If the source contains wavelengths, they will be displayed, along with the total flux for the wavelength and a weight of 1. You can enter weight values to change the spectral balance of the source. If the source contains no wavelengths, you must enter your own by typing in a wavelength (in μm) and clicking Add (or pressing

Enter). You can delete wavelengths by selecting them in the table and clicking Delete.

Note: By selecting the Center Position as the origin (0, 0, 0), and the Rotation Angles as 0, the rays will be emitted from the XYZ location specified in the ray file, and will propagate in the direction of the XYZ direction vectors specified in the ray file. Selection of any other Center Position or Rotation Angle will effectively “add an offset” to the positions and/or direction vectors specified in the ray file.

You can change to radians by clicking the *in Degrees* button, which toggles between radians and degrees. Selecting the button changes the name on the button to *in Radians*. You can change back to degrees by clicking the button again.

To modify an existing source, first select it in the Source Tree and select **Define|File Source** (or simply double-click on the name of the source in the Source Tree). Change entries as desired and click Modify to modify the source.

Capability to trace % of rays

TracePro allows you to trace a subset of the rays in a ray file using the “Trace % of rays” field. This is useful for tracing a relatively small number of rays from a large ray file to make sure your model is set up correctly. When the value is set to less than 100%, you can get a different subset of rays by changing the *Random Seed* in **Raytrace|Raytrace Options|Options**. Entering a value less than 100 will reduce the total flux of the source by an unknown amount, because each ray in the ray file has a unique flux value assigned to it.

Capability to scale flux

The total flux in the ray file can be scaled using the “Scale flux” field in the File Source dialog. The total flux of the source is displayed in the File Source dialog to facilitate this data entry. For a ray file emitting 5W, entering “1.05” for “Scale Flux” will increase the flux of each ray such that the Total Flux emitted will now be 5.25W.

Modify the File Source

Changing Source Location and Orientation

To move and rotate the source, you can either use the Move Source and Rotate Source options or open the File Source dialog either from the Source tab in the System Tree or by using **Define|File Source**. For the latter method, select the source to change and update the values. For the former method see “” on page 5.30. When a File Source is selected in the Source tab in the System Tree, a sphere is drawn in the Model window showing the location source’s center and maximum radius of the rays’ starting points from the center. The sphere is drawn in the color selected in the File Source dialog.

Changing File Source Data

Ray files may be downloaded from a source manufacturer’s web site, generated by using the opsira luca’rayset software, the ProSource® software, the Bitmap Source Utility - **Utilities|Bitmap Source**, by saving an Incident Ray Table as a ray file, or by hand using a text editor or spreadsheet program. Both ASCII and Binary formats are supported. For more detailed information on the ray file

formats, please refer to the TracePro on-line help: Contents(tab) | Define Commands | File Source | Ray File Format.

You may want to modify data within a ray file, but that file is used in multiple TracePro models. The next time one of those models is opened and a raytrace is performed, you might be surprised to obtain a different analysis result, not realizing that the ray file had been modified. TracePro warns of this condition. When the TracePro file is saved, the last modified date of any ray files are stored as part of the oml file. The next time that TracePro file is opened, TracePro checks to see if any of the ray files now have a later date than the date that was stored. If this occurs, the following warning message is displayed:

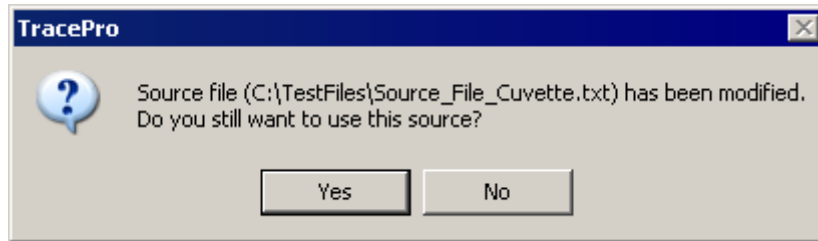

FIGURE 5.14 - Warning of Ray File Modification

Please note that this check is not performed before each raytrace. If the TracePro oml file remains open, the ray file can be modified, and the “modified” rays can be traced without warning.

Image Sources

This feature enables you to insert a standard RGB image file into a TracePro model and use it as a source of light. The Image Source dialog box shown in Figure 5.15 allows you to choose an image file, then select the emission from it in either radiometric or photometric units.

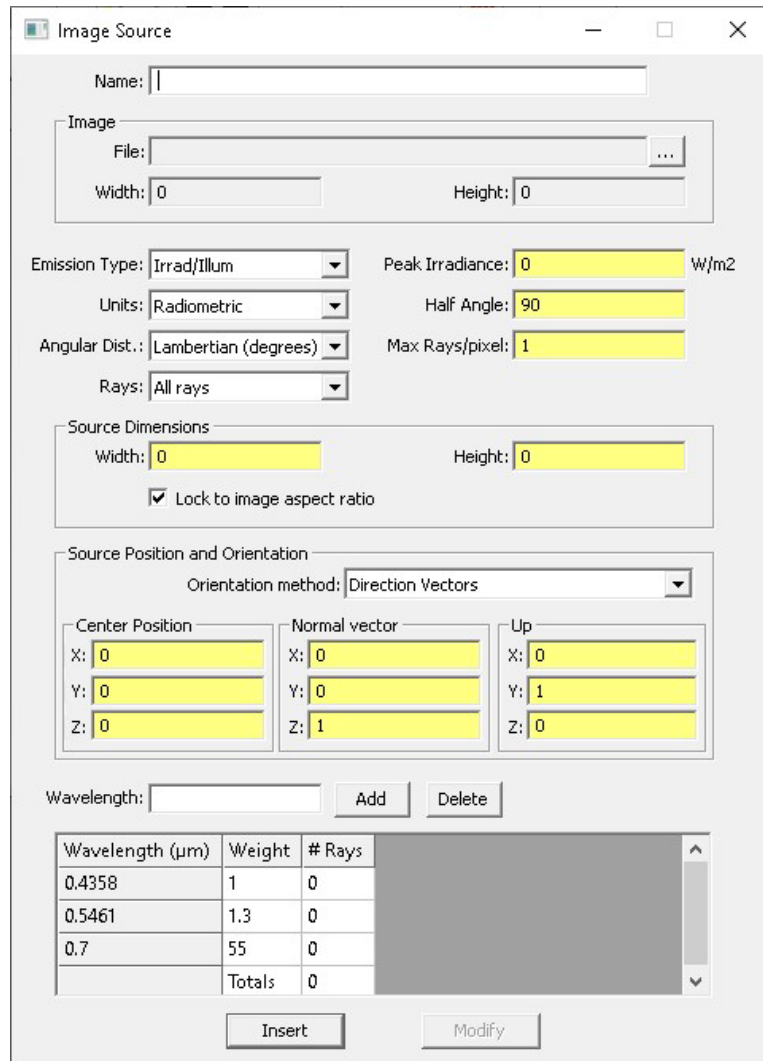

FIGURE 5.15 - Image Source dialog box

Each of the red, green and blue pixel values emit light at three wavelengths you assign, one for each color. You also enter the size, position, and orientation of the source. To create an Image Source, you need to specify:

- Name of the source
- Path to the image file (bmp, jpg, png, gif, or tif)
- Image width and height in pixels (for information only, this is read from the file)
- Emission type (Irradiance/Illuminance or Radiance/Luminance)
- Units: radiometric or photometric
- Angular distribution: Lambertian, Uniform, or Gaussian
- Rays to emit: all, random only, or importance sampled only
- Peak value of the emission type – emission value of a pure white pixel, i.e. RGB = (255,255,255)
- Half angle of the emitted distribution

- Max rays per pixel – a pure white pixel will emit this many rays for each color.
- Source dimensions: the width and of the source in model units.
- Source Position and Orientation
- Wavelengths and weights – an image source must have three wavelength
 - The first wavelength is used for emitting blue pixel values
 - The second wavelength is used for emitting green pixel values
 - The third wavelength is used for emitting red pixel values
 - To change a wavelength, Add a new wavelength and Delete an existing wavelength

After you have entered all the data, click Insert, and TracePro will do the following:

- Create a rectangular Thin Sheet according to the values specified by Source Dimensions and Source Position and Orientation.
- Display the image file superimposed on the thin sheet.
- Attach the Image Source data to the thin sheet.

When creating an image source, beware that the number of rays emitted is proportional to the number of pixels, as specified by the Max Rays/pixel entry. Therefore large, high-resolution images will generate many rays and take a long time to complete the raytrace.

Figure 5.16 shows a color test image created in a TracePro model, and Figure 5.17 shows a Photorealistic Render of the color test image.

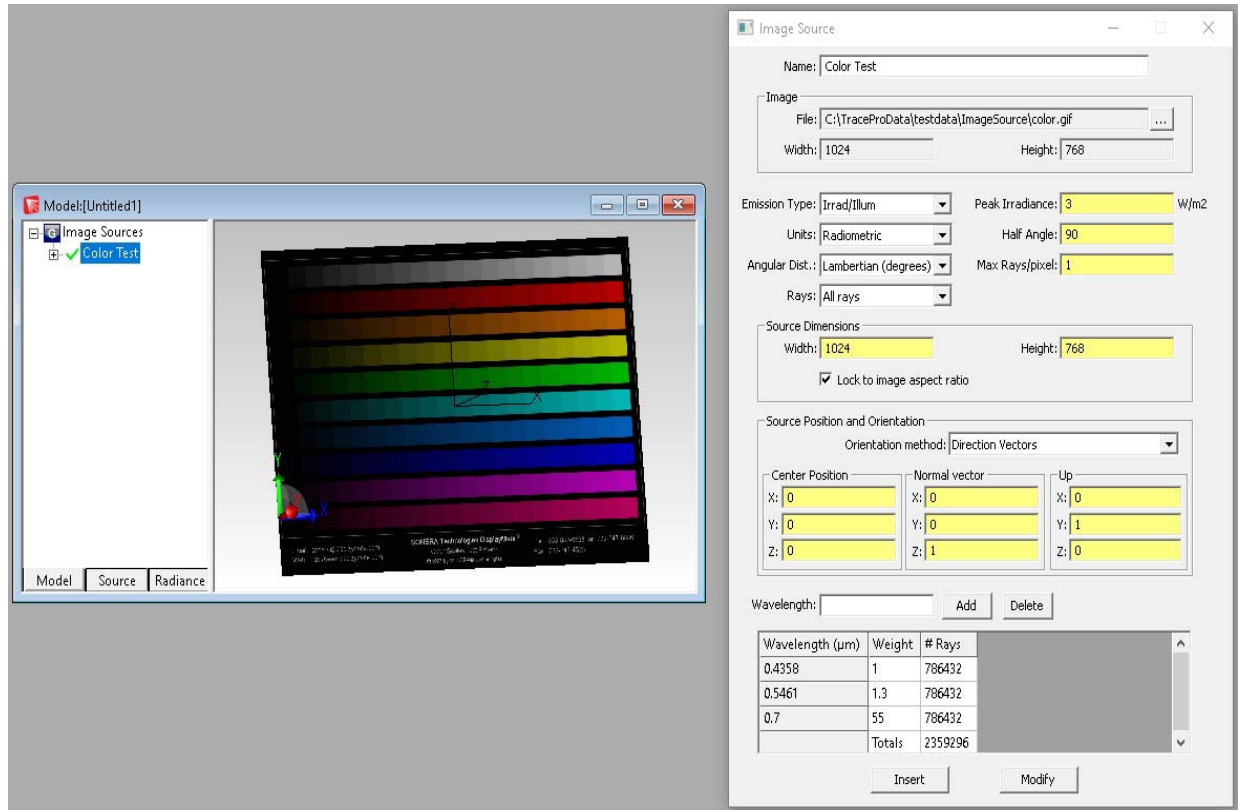

FIGURE 5.16 - Color test image inserted into a TracePro model and displayed on the resulting thin sheet

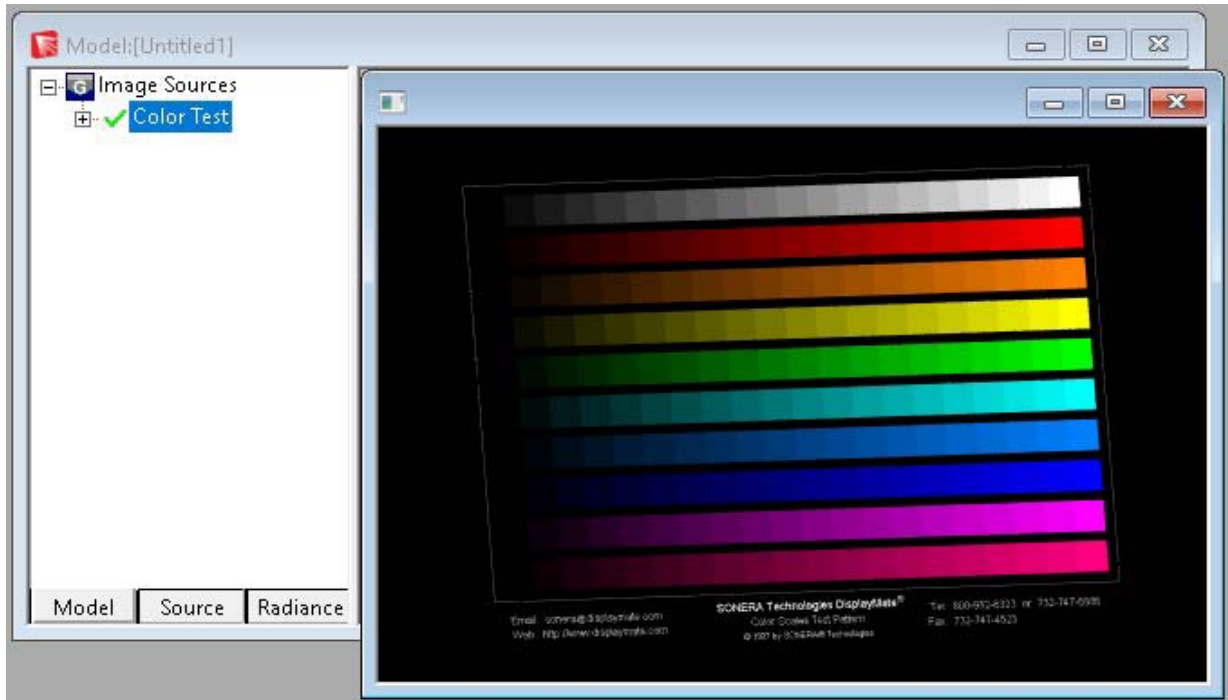

FIGURE 5.17 - Photorealistic rendering of color test image

Ray File Wavelength Editor

This command opens a ray file, either binary or text, and allows you to edit the wavelengths in the file.

To select a ray file source to modify it, first select **Define|Ray File Wavelength Editor**. In the dialog box, type in the name of the path of the file you wish to edit, or browse to the file by clicking the [...] button. Once the file is open, the wavelengths will be displayed. To change one or more wavelengths, you can simply type in a new wavelength, or scale the wavelengths using the *Scale factor* value. Finally, click *Save As* to save the modified file.

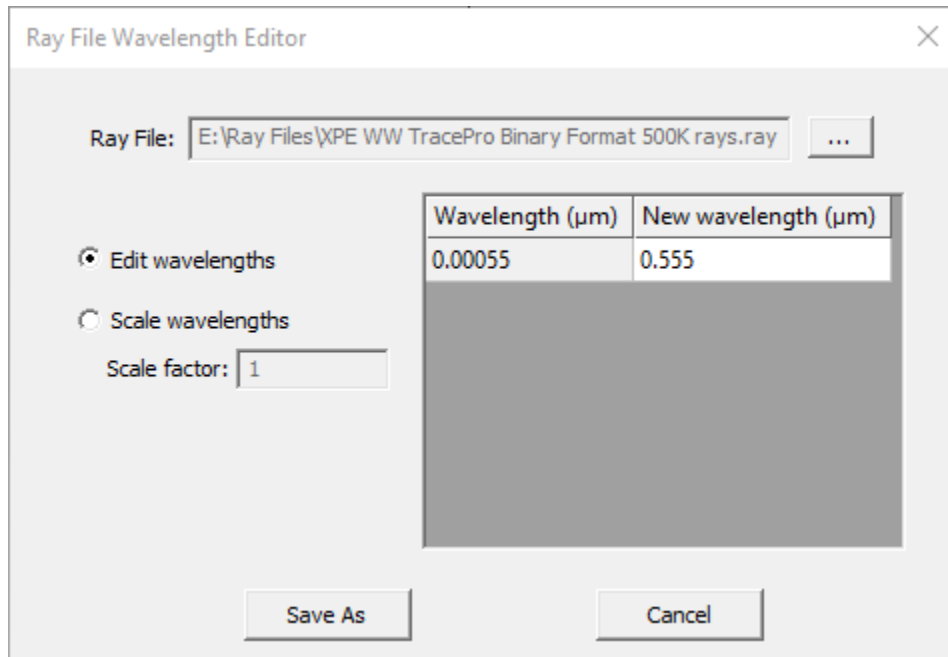

FIGURE 5.18 - Ray File Wavelength Editor

Ray File	The path to the Ray File. Browse to the file using the browse button.
Wavelength	A list of wavelengths in the ray file.
New Wavelength	A list of wavelengths that will replace the wavelengths in the ray file.
Edit Wavelengths	This selection allows you to directly type in new wavelengths.
Scale Wavelengths	Applies a scaling factor to each wavelength in the file.
Scale factor	Factor by which the wavelengths in the file will be scaled.
Save As	Save the file with the new wavelengths.

Source Builder

The Source Builder helps you create different types of sources using different source "wizards":

- Convert LED specifications to a Surface SourceProperty.
- Convert an IES source photometric file to a Surface Source Property.
- Convert an image to a File Source (rays launched at pupil).

- Convert LightTools® ray file to TracePro ray file.

You can also use the Source Builder to manually create sources.

To open the Source Builder, select **Define|Source Builder**.

The Source Builder has its own help system.

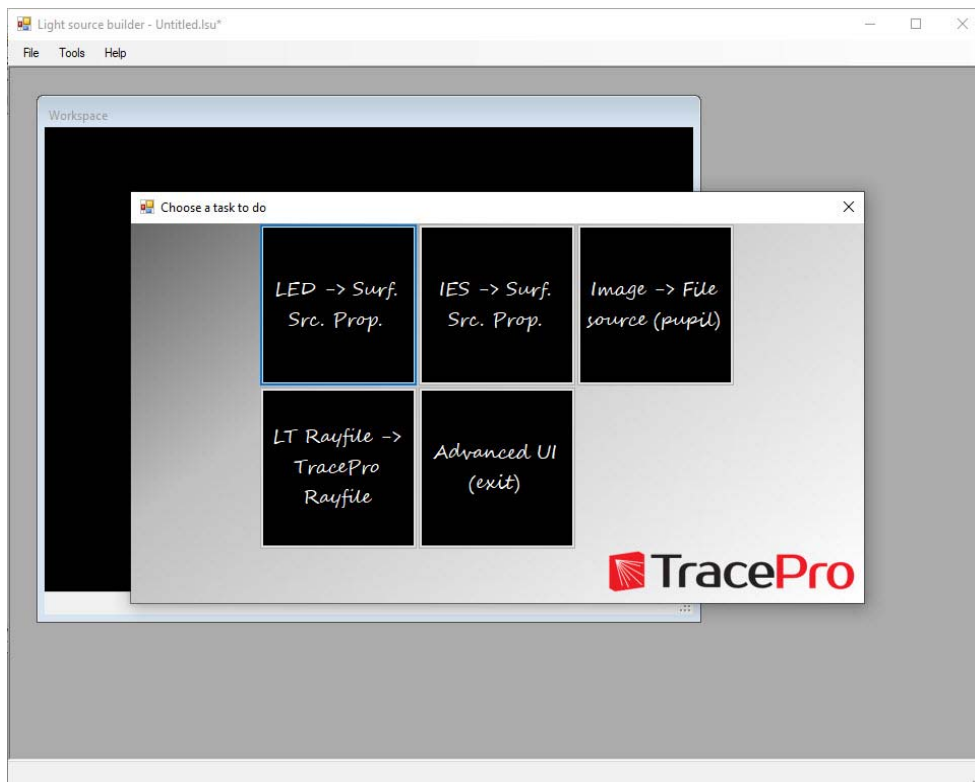

FIGURE 5.19 - Source Builder

Orienting and Selecting Sources

You can select, move, and rotate sources. Multi-select gives you the option to select multiple surface, grid, and file sources to accomplish actions for the selected sources. The ability to move and rotate grid and file sources through the Source Tree tab interface, especially in light of the multi-select source capability, gives you the ability to be more efficient and less prone to user-input error during development of your system. An example to illustrate the utility is provided in “Anisotropic Surface Property” on page 9.41.

Multi-Selecting Sources

You can select multiple sources, file, grid, and surface, by left clicking a given source while holding the Ctrl or Shift key. The following actions occur while holding down one of the keys:

- Shift: Selects a list of sources, up or down, from the currently selected one to the one on which you have clicked

- Ctrl: Selects the clicked source adding it to a list of sources. The final selected list does not need to be contiguous.

You can use the Shift and Ctrl keys in conjunction to each other to select contiguous and distinct sources. The Shift and Ctrl key left-click operations are standard Windows operations. These actions also work in many other TracePro windows, including the Model Tree tab.

By right-clicking on one of the selected sources, you get a pop-up menu with many options to Move or Rotate Source for Surfaces Sources (Figure 5.20).

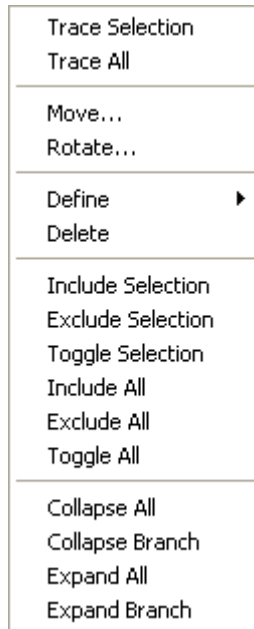

FIGURE 5.20 - Right-click pop-up menu in Source Tree

Move and Rotate Dialogs

With one or more Grid or File Sources selected, you can Move Source or Rotate Source. To move or rotate a Surface Source you must use the Move or Rotate option in the Model Tree for moving or rotating the object that contains the Surface Source. Figure 5.21 shows the dialog for Move Source, while Figure 5.22 shows the dialog for Rotate Source.

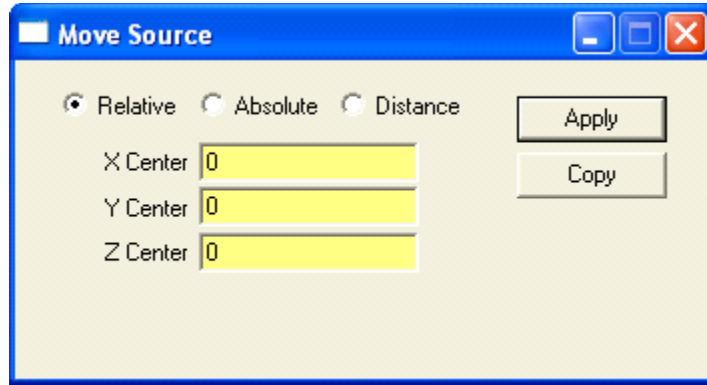

FIGURE 5.21 - Move Source dialog.

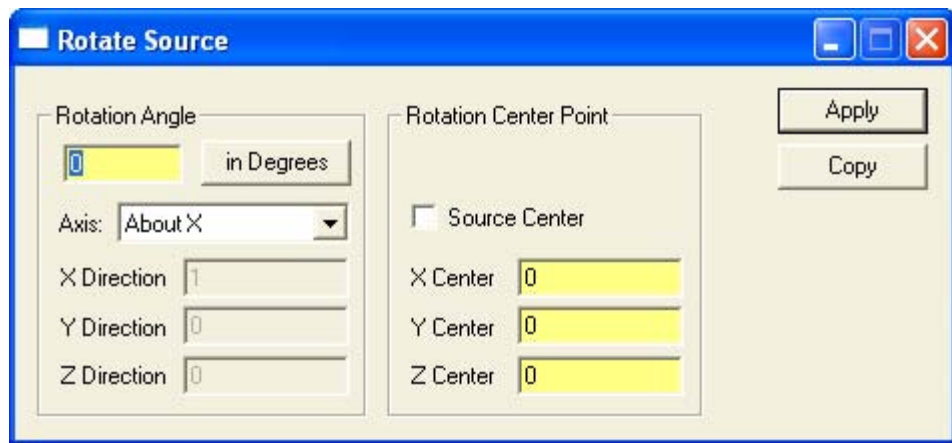

FIGURE 5.22 - Rotate Source dialog.

Sources Editor

A Spreadsheet style editor is available to view and modify sources. This editor provides an interface to modify individual sources and allows setting and scaling source data for multiple sources. Open the editor using the **Define | Source Editor** menu selection. The list selection at the top allows you to modify Surface, File, or Grid sources.

	Object Name	Surface Name	Type	Units	Flux/Temperature	Unit	Distribution	Total Rays	Min. Rays	Emissivity/Scale	Catalog	Name
1	Blue LED	emitting source	Flux	Radiometric	300	Watts	Surface Absorptance	10000	10000			
2	Green LED	emitting source	Flux	Radiometric	300	Watts	Surface Absorptance	10000	10000			
3	Red LED	emitting source	Flux	Radiometric	300	Watts	Surface Absorptance	10000	10000			

FIGURE 5.23 - Sources Editor

Within the editor, changes are made to the numeric values by typing new data in the appropriate cell. For the Surface Source selection, Source Type, Units, and Distribution data cells provide lists of options to select from. Several sources may be modified by selecting cells and pressing the Modify Selection button. An example of multiple source editing follows in the next section.

Scaling the Total Rays for Several Sources

To modify several sources simultaneously:

1. Select one or more source parameters as shown in Figure 5.24. In this example the selection includes the Total Rays for all defined sources.
2. Press *Modify Selection* to display the Modify Selected Source Parameter dialog which provides an entry for a new parameter value or scale factor. See Figure 5.24.
3. Press Scale to apply a scale factor the selected values, or Set To to change the values to a new value.

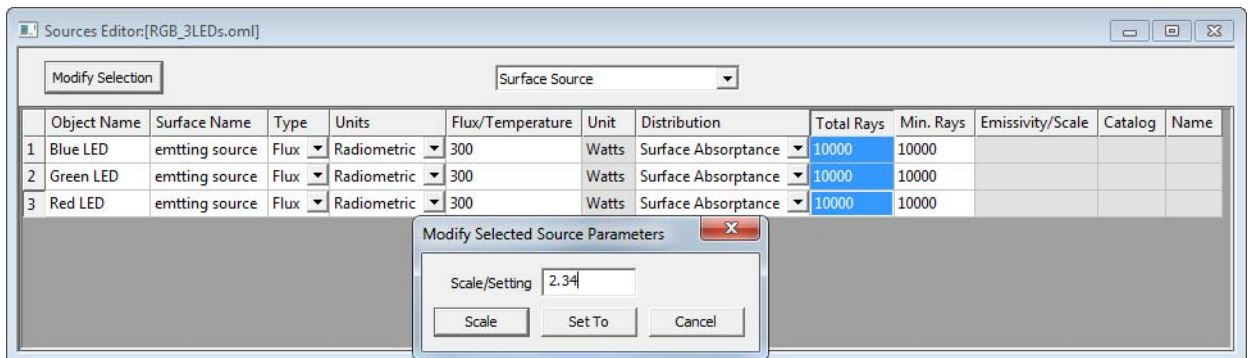

FIGURE 5.24 - Sources Editor Modify Dialog box

When Selecting parameter cells, the <Shift> and <Ctrl> keys allow extending the selection in the usual ways. Selections may be made across rows and columns as shown in Figure 5.25.

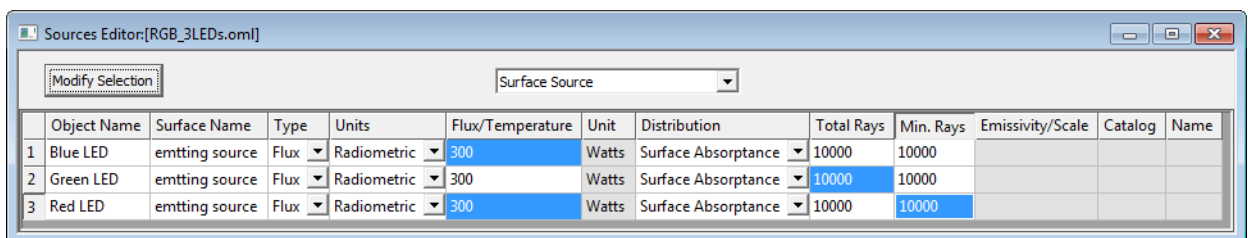

FIGURE 5.25 - Extended selection in numeric data cells

The source Type, Units, and Distribution are altered using a drop down list by pressing the list arrow as shown in Figure 5.26.

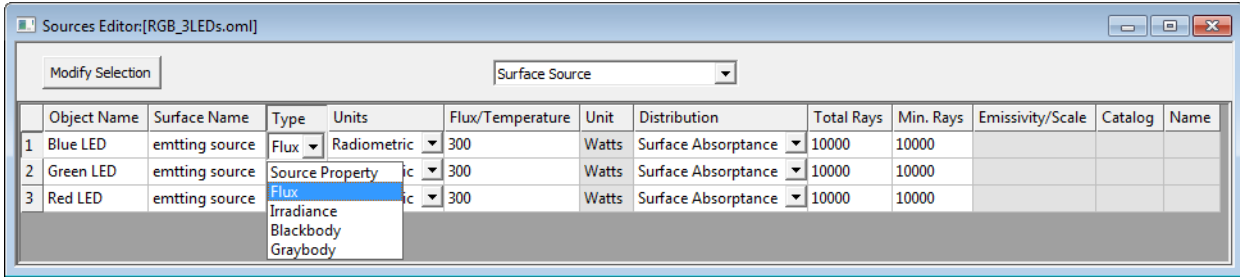

FIGURE 5.26 - Source Type dropdown list

Tracing Rays

Raytracing is the fundamental tool for performing simulations in TracePro. This next section covers the three types of raytracing, Standard, Reverse and Luminance/Radiance.

Standard (Forward) Raytrace



Standard or Forward raytracing is the normal method used to simulate the flux propagation in a TracePro model. Rays will emanate from all of the sources defined in the model as described above. Initiating the raytrace is done by selecting **Raytrace|Trace Rays** or pressing the Trace Rays button on the toolbar.

Most sources are defined as using “discrete wavelengths”. Surface sources defined as Blackbody or Graybody sources will use “calculated wavelengths.” Surface Sources that use a Surface Source Property may use either discrete wavelengths or calculated wavelengths.

The raytrace begins when **Raytrace|Trace Rays** is selected, or the toolbar button is clicked. First, a dialog box will open, asking which ray-tracing mode you wish, either *Analysis Mode* or *Simulation Mode*. For a discussion of which mode to use in what circumstances, see “Ray Tracing modes” on page 5.54. During the raytrace a progress dialog box opens to indicate progress of the raytrace. You can interrupt or pause the raytrace at any time by clicking Cancel on the Raytrace Progress dialog box and TracePro will finish tracing the current ray. You can resume the raytrace by selecting **Raytrace|Resume Raytrace**. The raytrace resumes starting at the next consecutive ray number in the raytrace.

Reverse Ray Tracing Standard Expert



TracePro has the capability to perform reverse ray tracing. Tracing rays in reverse is useful in situations where importance sampling in the forward direction is difficult or impossible. This is true, for example, in the design of a reflector coupled to a source for which only a few points in the output plane need to be sampled, such as for a low-beam head lamp above the horizon. Note that when source(s) are listed below, it refers to surface sources. Reverse ray tracing does not apply to grid and file sources.

Specifying reverse rays

In summary, to do a reverse ray trace you must perform the following steps:

1. Set up the model with surface source(s) and exit surface(s) as usual.
2. Define importance sampling to be used by the exit surface(s) during the Reverse Raytrace. This is done using the existing Importance Sampling tab in the Apply Properties dialog box.
3. Define the number of reverse rays to trace for each exit surface. This number is entered in the Exit Surface tab of the Apply Properties dialog box.
4. Select **Raytrace | Reverse Raytrace** to start the ray trace.
5. The process of analysis is the same as if a forward ray trace has been performed. By selecting one of the exit surfaces you can display the Irradiance or Illuminance Map for this surface. In other words it is as if the rays had been traced in the forward direction. The irradiance/illuminance from all surface sources is displayed on the selected surface.
6. To display sorted rays, select the surface of interest - usually an exit surface - and the rays at that surface will be displayed as though the rays were traced forward.
7. The Incident Ray Table and the Ray History Table are displayed in the same way as for forward rays.
8. The only options available for Candela plots are rays exiting a surface and rays incident on a surface. The “missed rays” option is not available for Candela plots with reverse ray tracing.

Note: If there is no importance sampling specified for an exit surface, no rays will be emitted from that exit surface.

Note: Reverse ray tracing does not apply to grid and file sources - only surface sources are used.

Theory of reverse ray tracing

Reverse ray tracing allows efficient sampling of rays in illumination design when only a few local points on the output plane need to be sampled. By tracing rays in reverse from the output plane and importance sampling toward a reflector, only a few rays need to be traced to get good sampling for the purposes of design. Designing in this manner consists of choosing a few representative points on the output plane, and tracing rays toward importance sampling targets. Rays are “absorbed” by the surface source in proportion to the radiance/luminance of the source at that direction and position. The absorbed flux is referred back to the point on the output plane where the ray started.

Specifically, in forward ray tracing, the flux of the emitted ray is

$$d\Phi_s = \frac{L_s dA_s d\Omega_s}{N}, \quad (5.1)$$

where L_s is the source radiance, dA_s is an element of projected area on the source surface, $d\Omega_s$ is an element of solid angle, and N is the number of rays emitted from the surface element into the solid angle. When the forward ray reaches the output plane, the resulting irradiance is

$$dE_o = \frac{d\Phi_s}{dA_o}, \quad (5.2)$$

where dA_o is an element of area on the output plane.

In reverse ray tracing, the “flux” of the ray emitted from the output plane is unknown, only the $A\Omega$ product, étendue, of the ray is known. If the ray hits the source, the flux of the ray at the output plane can be computed as

$$\Phi_o = \frac{L_s A_o \Omega_o \tau}{N}, \quad (5.3)$$

where Ω_o is the solid angle of the ray as it is “emitted” from the output plane, i.e. the solid angle subtended by the importance sampling target, and τ is the “transmittance” experienced by the ray along its path from the output plane to the source. Rays missing the source are not “seen” at the exit surface since the path would not have come from the source. For example, if a ray is emitted from an exit surface, reflects from a reflector with reflectance of 0.9 and passes through two glass surfaces each with transmittance 0.96 before striking a source surface, then the ray’s transmittance is $0.9 \times 0.96 \times 0.96 = 0.829$.

Luminance/Radiance Ray Tracing

Luminance and Radiance Maps will be covered here as the third ray trace method since they are so closely linked to the ray trace. The options associated with the view of the data is covered in Chapter 6. See “Luminance/Radiance Maps” on page 6.18

You can obtain a Luminance or Radiance Map or rendered image (Photorealistic Rendering) of a TracePro model that is illuminated by the actual surface and/or file sources and uses the surface and material properties in the model. You can generate as many maps/renderings of a model as you like by defining a name for each one. Luminance/Radiance maps work with surface and file sources, not with grid sources.

Note: The wording of the **Luminance/Radiance** tab in the System Tree window is automatically set to either **Luminance** or **Radiance** by TracePro depending on analysis units of the model (see page 5.43). For convenience, Luminance,

Radiance and Photorealistic Rendering will be referred to as **Luminance** for the remainder of this section.

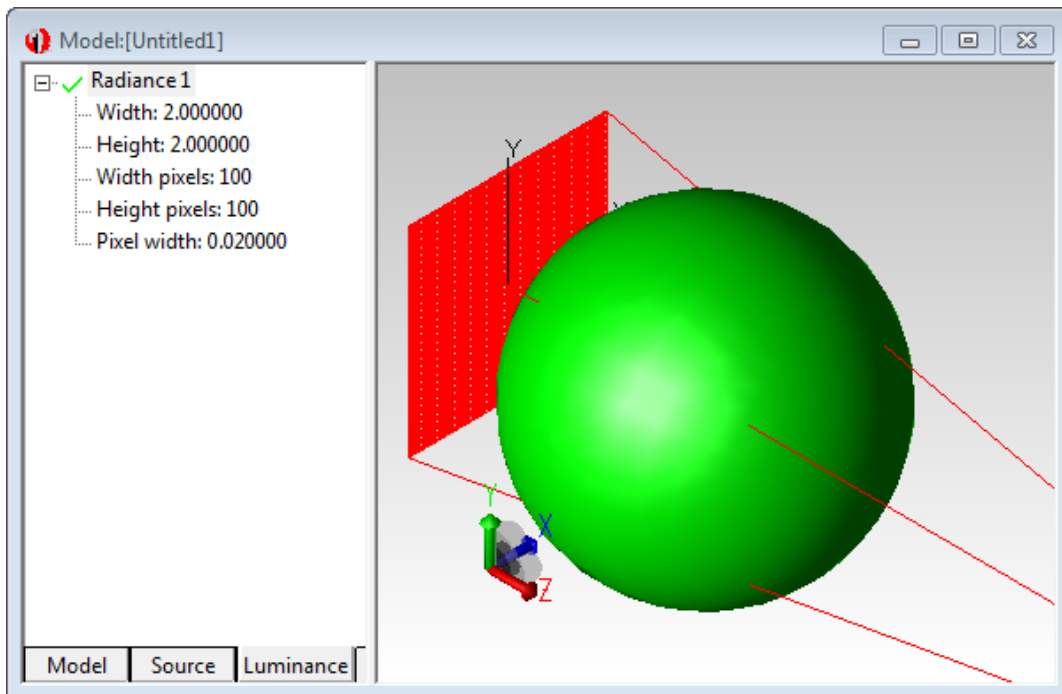

FIGURE 5.27 - Luminance Tab in the System Tree with Luminance defined map displayed in the Model Window.

The plots are defined either from the Luminance tab in the System Tree by right clicking in the window or from the **Define | Luminance/Radiance** menu item. The Luminance tab is used to display all of the defined plots and to edit or add additional plots to the model, or to delete plots. The Luminance tab is shown in Figure 5.27.

Remember that the title of the dialog box will be *Radiance* if radiometric units are selected, or *Luminance* if photometric units are selected. You can choose the units by selecting **Raytrace | Raytrace Options**. The Options tab contains the selection for radiometric/photometric analysis units.

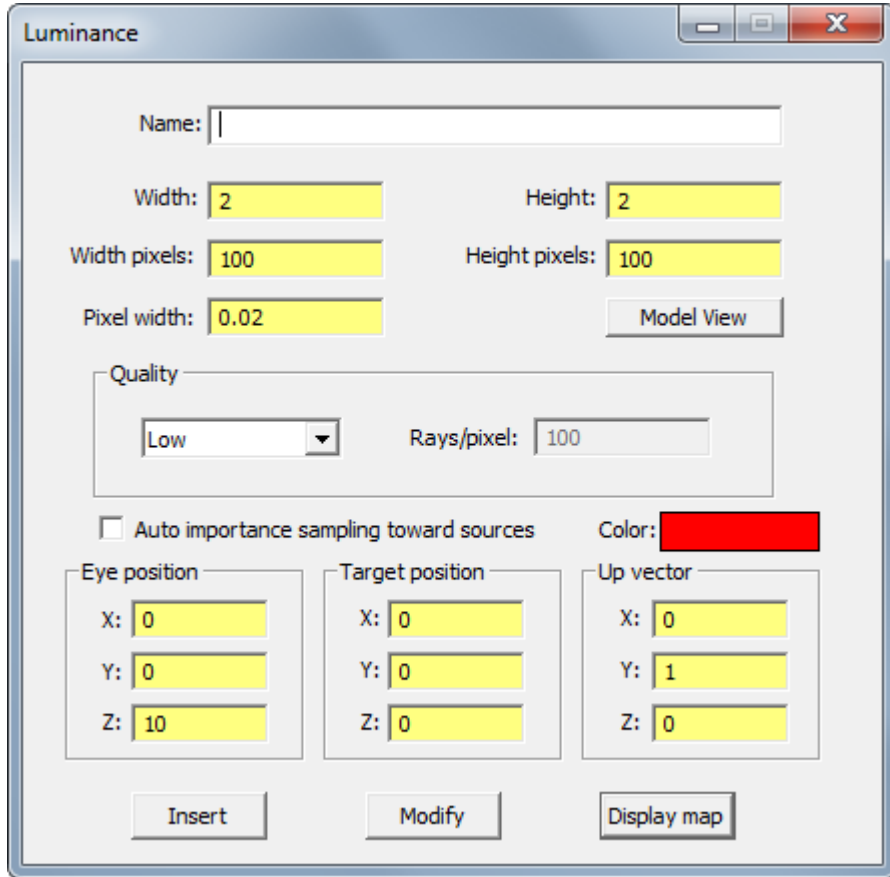

FIGURE 5.28 - Luminance dialog box.

The rendering is accomplished by tracing rays in reverse. See “Theory of reverse ray tracing” on page 5.37. To set up a luminance map, specify the eye position and the target position and ray tracing parameters by the following steps:

1. Open a model for which you wish to generate a map or rendering.
2. Orient the view using the View menu commands to an orientation from which you would like to generate the map/rendering.
3. Select **Define | Luminance/Radiance** from the TracePro main menu to open the Luminance/Radiance dialog box as shown in Figure 5.28.
4. Enter a name in the dialog box.
5. To import the eye position, target position, up vector, width and height from the current view of the Model Window, click the Model View button. Otherwise, enter the eye position, target position, up vector, width and height you wish to use.
 - a. The eye position is a Cartesian (x,y,z) point in space representing the point of view from which the scene will be generate, and can be thought of as a camera position.
 - b. The target position is a Cartesian (x,y,z) point in space representing the center of the rendering/map that will be generated and can be thought of as the position towards which the camera is pointing.
 - c. The up vector defines what direction is up in the rendering/map.

- d. Width represents the horizontal width of the map in system units.
 - e. Height represents vertical height of the map in system units.
6. Set the number of pixels in the horizontal or vertical direction. When you set one value, the other is automatically computed from the aspect ratio as determined by the height and width values.
 7. Choose the picture quality. This determines the number of rays that will be traced. You can choose Low, High, or Custom.
 8. Click on the checkbox *Auto importance sampling toward sources* in order to improve the sampling since the number of useful rays traced in reverse to the sources will be higher. Using Auto importance sampling will reduce the noise in the resulting map or rendering when there are scattering surfaces in the model. You will need to lower the flux threshold, when using importance sampling, just as you need to for forward ray tracing. You can also manually apply importance targets in addition to or instead of using Auto importance sampling, but remember that rays are being traced in reverse, and define your targets accordingly. An example is provided in “Example Using Luminance/Radiance Maps” on page 9.65.
 9. Once you have the settings the way you wish, click the *Insert* button to create the Radiance/Luminance map. TracePro will draw a wireframe representation of the settings on top of the geometry whenever the Radiance source is selected.
 10. Once you are ready to do the analysis, select **Raytrace|Trace Luminance/Radiance**. TracePro will begin the ray trace using the wavelengths defined for each surface source. A Progress dialog box will open and display the % complete, elapsed time, and estimated time remaining.
 11. When the ray trace is complete, click the *Display map* button to display the map/rendering.

To modify an existing Luminance/Radiance setup, simply double-click on its name in the Radiance/Luminance tab in the System tree, or select **Define|Luminance/Radiance** and select the Luminance/Radiance map in the tree. Then change any values as needed and click *Modify*.

Chapter 6 will cover what is displayed for a Luminance map and the options to modify the map format. See “Luminance/Radiance Maps” on page 6.18

Raytrace Options

The Raytrace Options dialog box is opened by selecting **Raytrace|Raytrace Options**, as is shown in Figure 5.29. Note this depiction is only for the Standard and Expert editions of TracePro. This dialog controls various aspects of the raytrace.

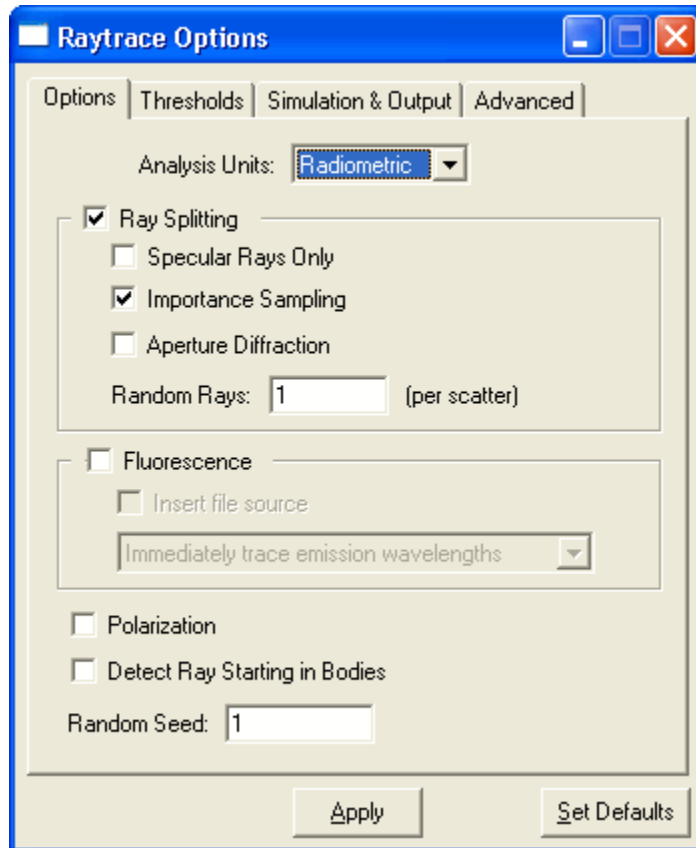

FIGURE 5.29 - Raytrace Options Dialog for Standard and Expert editions of TracePro

The Raytrace Options are saved when the Model is written to disk in an OML file. After the data is changed, pressing the Set Defaults button stores the data into the TracePro defaults files to be used the next time TracePro is opened. See “User Defaults” on page 1.11

LC See “Simulation Options for TracePro LC” on page 5.48 to view the Options Dialog for the LC edition of TracePro.

Options

The Options tab of the **Raytrace|Raytrace Options** dialog box allows you to set parameters that affect how the raytrace is done. They affect the entire model.

- You can select whether importance sampling is done during the raytrace by checking the Importance Sampling check box.
- The Random Rays box allows you to set how many randomly scattered and/or diffracted rays are generated whenever a ray strikes a scattering or diffracting surface.
- Finally, you can set the random number seed and radiometric units.

Analysis Units

The Analysis Units entry lets you choose between radiometric units or photometric units. The radiometric and photometric units used in TracePro are SI units. The units have the meanings summarized in Table 5.6.

TABLE 5.6. The Choice of Radiometry and Photometry Units

	Radiometry		Photometry	
	Name	Unit	Name	Unit
Power	Flux	Watt (W)	Luminous flux	lumen (l)
Power/area	Irradiance*	Watt/meter ² (W/m ²)	Illuminance	lux (lx)
Power/solid angle	Radiant Intensity	Watt/steradian (W/sr)	Luminous intensity	candela (cd)

*The Irradiance is on an illuminated surface. The Radiant Exitance is what is emitted (from a source or scattered from an illuminated surface). For the latter, the exitance is $(1-a)*E$, where a is the absorption and E is the irradiance.

The choice of radiometric or photometric units affects the display of units throughout TracePro. Units are displayed in TracePro as indicated in Table 5.7.

TABLE 5.7. Effect of the choice of Units in TracePro

Place	Radiometric label(s)	Photometric label(s)
Irradiance/Illuminance map – top	Total - Irradiance Map	Total – Illuminance Map
Irradiance/Illuminance map – units	Unit = W/m ²	Unit = lux
Irradiance/Illuminance map – flux	Unit = W	Unit = lumen
Irradiance/Illuminance map options - Map Type	Irradiance	Illuminance
Intensity/Candela plot	Intensity - W/sr	Luminous Intensity - candela
Luminance/Radiance map	Radiance - W/m ² -sr	Luminance - cd/m ² (nit), footlambert, or millilambert

Ray Splitting

Placing a check mark in the Ray Splitting check box lets you apply selections for Specular Rays Only, Importance Sampling, Polarization, and Aperture Diffraction to your raytrace.

In “crude” Monte Carlo ray tracing, there is no ray splitting or importance sampling. Each time a ray strikes a surface, the absorption, reflection, and transmission coefficients of the surface are used as probabilities, and one ray component is chosen randomly, weighted by these coefficients. For example, suppose a surface has absorptance equal to 0.1, reflectance equal to 0.2, and transmittance equal to 0.7 (these coefficients must sum to one to satisfy the principle of conservation of energy). When rays strike the surface, 10% of the time they are completely absorbed, 20% of the time they are completely reflected, and

70% of the time they are completely transmitted. That result is achieved by the following method: when a ray strikes the surface, a random number is chosen between zero and one. If the number is between 0 and 0.1, the ray is absorbed. If the number is between 0.1 and 0.3, the ray is reflected, and if the number is between 0.3 and 1.0, the ray is transmitted. The fraction of incident flux reaching the exit surface of the model is determined by simply counting up the number of rays that are absorbed by it and dividing by the number of rays started in the simulation.

If you enable ray splitting, when a ray intersects a surface, several split ray components are generated. The flux from the ray at the intersection is split between the ray components according to their absorption, reflection, and transmission coefficients. Since the number of split rays grows geometrically, a large number of ray segments is created causing TracePro to use a large amount of computer memory. It is important for you to know that if you have a non-imaging system model in which surfaces reflect and transmit light almost equally, you can turn off ray splitting.

In a system model, many split rays are terminated when their flux falls below the flux threshold, keeping the number of ray components to a manageable number. If the use of ray splitting causes the raytrace to proceed slowly, check to be sure that the flux thresholds are not set too low. If the raytrace is slow even with appropriately set flux thresholds, try turning off ray splitting.

At coincident surfaces between two objects, TracePro follows a detailed method for determining the reflectance, transmittance, and absorptance for the rays. See “Coincident Surfaces” on page 7.15 for a complete discussion of this method.

No ray splitting in RepTile

When a ray enters a Reptile Cell, ray splitting is temporarily turned off. When a ray leaves the RepTile cell, Ray Splitting returns to its former setting.

Specular Rays Only Standard Expert

Checking the check box for Specular Rays Only limits the rays to be traced to those segments using specular reflection and transmission. You can use this control to turn off tracing of scattered rays. This is useful for debugging your data or for doing specialized analyses such as ghost image analysis. Any flux that would normally be given to scattered rays is lost, in these cases Conservation of Energy is not ensured.

Importance Sampling Standard Expert

If the Importance Sampling check box contains a check mark, the importance sampling that you have specified is performed during a raytrace. Unchecking the box turns off importance sampling. If you are debugging your model and do not want importance sampled rays to be generated, turning off importance sampling is useful. If importance sampling is turned off, flux that might have been allocated to importance sampled rays is given to random rays.

Aperture Diffraction

Standard Expert

Checking the Aperture Diffraction check box causes TracePro to bend rays that pass close to a diffracting edge. Unchecking the check box causes any diffracting

surfaces to be treated as normal surfaces. For a discussion of setting up diffraction in TracePro, see “Defining Diffraction in TracePro” on page 4.32.

Random Rays

The Random Rays number specifies how many randomly scattered rays are generated when a ray strikes a surface with diffraction or with a surface property that has scattering. Random rays are those that are scattered in random directions, weighted by the BSDF.

The default value is 1. You can specify any positive number. A large number can cause the ray tree to be very wide, causing the raytrace to proceed slowly and too much memory to be consumed.

Fluorescence Expert

When a model includes Fluorescent properties (See “Fluorescence Properties” on page 4.7 and page 3.12), the effects of fluorescence emission is enabled by setting Fluorescence on in the Raytrace Options dialog. The emission wavebands need to be defined in the Wavelengths tab defined below. See “Fluorescence Properties” on page 3.12

After the initial excitation rays are traced you have the option to:

- stop the raytrace and not trace the emission rays (option: Generate emission source only)
- continue the raytrace and include the emission rays (option: Immediately trace emission wavelengths).

During the raytrace, fluorescent objects or bodies will emit rays simulating fluorescence emission. These rays are stored in File Sources to be used during the emission part of the raytrace. The **Insert file source** option is used to automatically include the file source(s) into the model. If **Insert file source** is left unchecked, the model will remain in its “pre-raytrace” state.

Polarization Standard Expert

Checking this box turns on the polarization ray tracing features of TracePro. A Stokes vector will be attached to each ray, and the Stokes vector may be modified when it interacts with a polarizing surface property, when passing through an object that has a Mueller matrix applied to it, or when passing through a birefringent material. You might notice a slowing of the raytrace and more consumption of memory when polarization is enabled.

Discussions and examples of Mueller matrices and Stokes vectors can be found in the Technical Reference section, “Mueller Matrices and Stokes Vectors” on page 7.57 and many textbooks including:

- E.L. O’Neill, [Introduction to Statistical Optics](#), Dover (1992),
- E. Collett, [Polarized Light](#), Dekker (1992),
- Shurcliff and Ballard, [Polarized Light](#), van Nostrand (1964),
- Kliger, Lewis, and Randall, [Polarized Light in Optics and Spectroscopy](#), Academic Press (1990)).

Detect Ray Starting in Bodies

There are occasions when using TracePro where rays are emitted from within an object or multiple layers of embedded objects. Checking *Detect Ray Starting in Bodies* will cause TracePro to correctly determine the properties associated with the starting point of a ray. Leaving this box unchecked will allow a faster raytrace.

Random Seed

TracePro uses pseudorandom numbers for a variety of tasks, for example, for setting the directions of scattered rays or the starting locations for a random grid or surface source. Whenever a random number is needed, a random number generator is used to obtain the random number. The random number generator requires a seed, or initial value, to get it started generating a sequence of pseudorandom numbers. If the seed is the same for two successive simulations, the same sequence of random numbers is generated. Because such a sequence can be an advantage or a drawback, TracePro lets you set that seed value. Most users never need to change this value.

Thresholds

The Thresholds tab of the Raytrace Options dialog box, as shown in Figure 5.30, controls the flux threshold and the intercept limits. Thresholds control the raytrace by providing limits on how long TracePro follows a ray. The most commonly used limit is the flux threshold. Rays started by TracePro from a source are traced and split until the flux carried by a ray component is below the threshold. At that point, that branch of the ray tree is terminated.

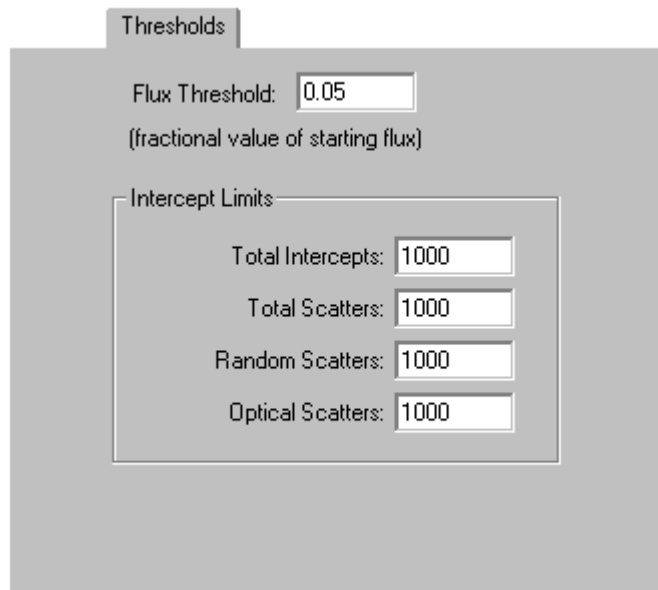

FIGURE 5.30 - Raytrace Thresholds Tab

The raytrace can also be controlled by limiting the number of intercepts. The number of intercepts is the number of ray-surface intersections that a particular ray path contains. You can terminate rays based on the following criteria:

- Total number of ray-surface intercepts for a ray path

- Total number of scattered components for a ray path
- Number of randomly scattered components for a ray path
- Number of components scattered by optical surfaces for a ray path. Optical surfaces are defined by a prescription property

For each starting ray, these limits control the number of intercepts allowed along each path. A ray will be terminated after it reaches the set intercept limit. The Total Intercepts limit directly controls the depth of the ray tree by controlling the number of nodes or branch points, while the other limits and thresholds indirectly control it. For example, if you set *Total Scatters* to 5, a ray will be terminated immediately after scattering for the fifth time.

Simulation and Output Standard Expert

The Simulation and Output tab of the Raytrace Options dialog box lets you control what data is saved during a simulation raytrace, and what results can be viewed after the raytrace is finished. To save ray data for an exit surface so that an irradiance map can be generated, check the Collect Exit Surface Data box. Checking the Collect Missed Rays Candela Data check box will save the rays that escape the model and “go off to infinity”. These rays are used for candela plots.

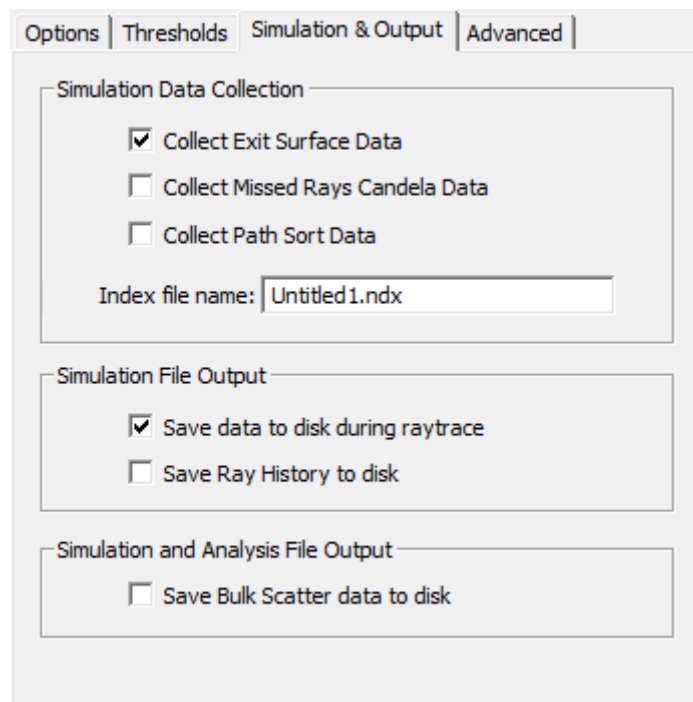

FIGURE 5.31 - Simulation and Output Tab

Collect Exit Surface Data

Data is collected for the Exit Surface defined by the Exit Surface Property. After the raytrace is complete, irradiance maps and ray tables can be displayed for the Exit Surface.

Collect Missed Rays Candela Data

Data is collected for rays that miss all objects, escape the model, and “go off to infinity.” After the raytrace is complete, Candela Plots can be displayed.

Collect Path Sort Data

Data is collected for unique ray paths. After the raytrace is complete you can display a *Path Sort Table*.

Index file name

The Index file name option is used to collect the simulation data files generated during a raytrace. This is used in conjunction with the “Save Data to Disk” option below.

One index file, with the NDX extension, can accumulate several simulation files, with SIM extensions, for several raytraces. When the simulation raytrace is started an options to specify a note for the raytrace is presented. The note is stored in the index file with links to the SIM data files. The SIM files are stored with the following name convention.

1. Missed Rays Candela Data - *BaseName_num_can.sim*
2. Exit Surface Data - *BaseName_num_exXX.sim*

Where *BaseName* corresponds to the Index file name, num is the raytrace number starting from 1 and XX is the Exit Surface number starting from 1. See “Simulation Mode” on page 5.55

Save Data to Disk during Raytrace

During the raytrace, TracePro may save the Exit Surface and Missed Rays Candela Data in a binary format (SIM file). One reason for using this option is to minimize RAM consumption during the raytrace. In addition, the data from the Exit Surface SIM file can be recalled from the Simulation File Manager (See “Simulation File Manager” on page 6.71).

Save Ray History to disk

A Ray History table for the Exit surface is generated and saved as a text file for the model. The file name is formed by appending “-rayhistory.txt” to the model name. Data is not written to disk if this option is not selected.

Save Bulk Scatter data to disk

A set of positions and flux values for each bulk scattered ray is generated and saved into a text file for the model. The file name is formed by appending “-scatter.txt,” to the model name. Data is not written to disk if this option is not selected.

Simulation Options for TracePro LC

For TracePro LC , Simulation information is set in the Options tab of the Raytrace Options dialog box, as shown in Figure 5.32. The two options let you control what data is saved during a simulation raytrace. To save ray data for an exit surface so that an irradiance map can be generated, check the Collect Exit Surface Data

box. To save ray data for candela/intensity plots, check the Collect Missed Rays Candela Data checkbox.

Collect Exit Surface Data

Data is collected for the Exit Surface defined by the Exit Surface Property. After the raytrace is complete, irradiance Maps and ray tables can be displayed for the Exit Surface.

Collect Missed Rays Candela Data

Data is collected for rays that miss all objects and are traced beyond the model. After the raytrace is complete, Candela Plots can be displayed.

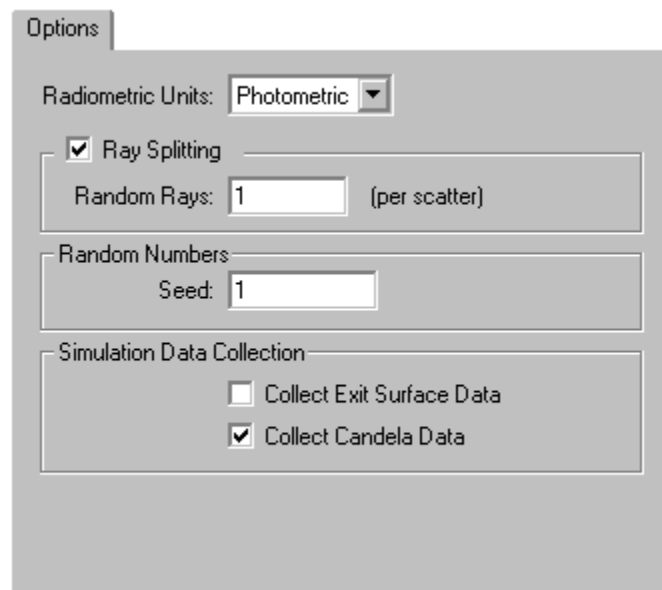

FIGURE 5.32 - Options Tab for TracePro LC

Advanced Options

The Advanced tab of the Raytrace Options dialog, as shown in Figure 5.33, provides controls to enhance ray-trace speed, and change the precision for tracing rays in gradient index materials. To control the ray-trace speed you can choose from two types of voxels. You also have the option to represent NURBS surfaces by facets.

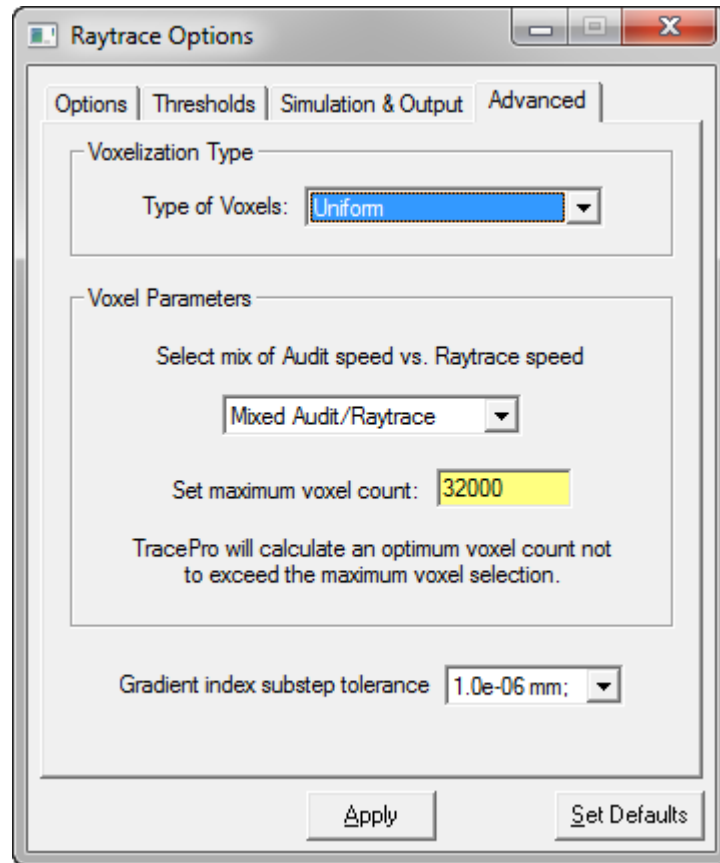

FIGURE 5.33 - Advanced Tab (Uniform Options)

Voxelization Type

To speed up a ray-trace, TracePro uses object space partitioning to break up a model into small regions called voxels. Think of voxels as 3D pixels, including depth along with width and height. Using voxels involves a trade-off of ray-trace speed versus audit speed and memory consumption. For most analyses, you can leave this setting at Uniform. However, some models with widely separated geometry may see a speed improvement with octree voxels.

Voxel Parameters

The Voxel Parameters, in the center of the Advanced tab, change depending on whether you choose Uniform or Octree voxels.

Uniform voxels

Typically, you would start the analysis of a complex or large model by tracing rays at the **Fastest Audit or Mixed Audit/Raytrace** setting. Perform any system setup and determination of thresholds with a relatively small ray set. When you are ready to trace many rays, change to **Fastest Raytrace**. TracePro will calculate an optimal number of voxels to use, but no more than the number in **Set maximum voxel count**. If you feel that your model would benefit from more voxels than TracePro is choosing, select **Maximize Voxel Count** and set the **Set maximum voxel count** number to the number of voxels you desire. Be aware that more

voxels use more memory. There is a minimum of 4 bytes of memory allocated for each voxel, and more memory is allocated for bigger models. At 4,000,000 voxels, you can expect a minimum of 16 MB of memory to be consumed. Figure 5.34 shows the voxels generated for a simple telescope using the Fastest Audit selection.

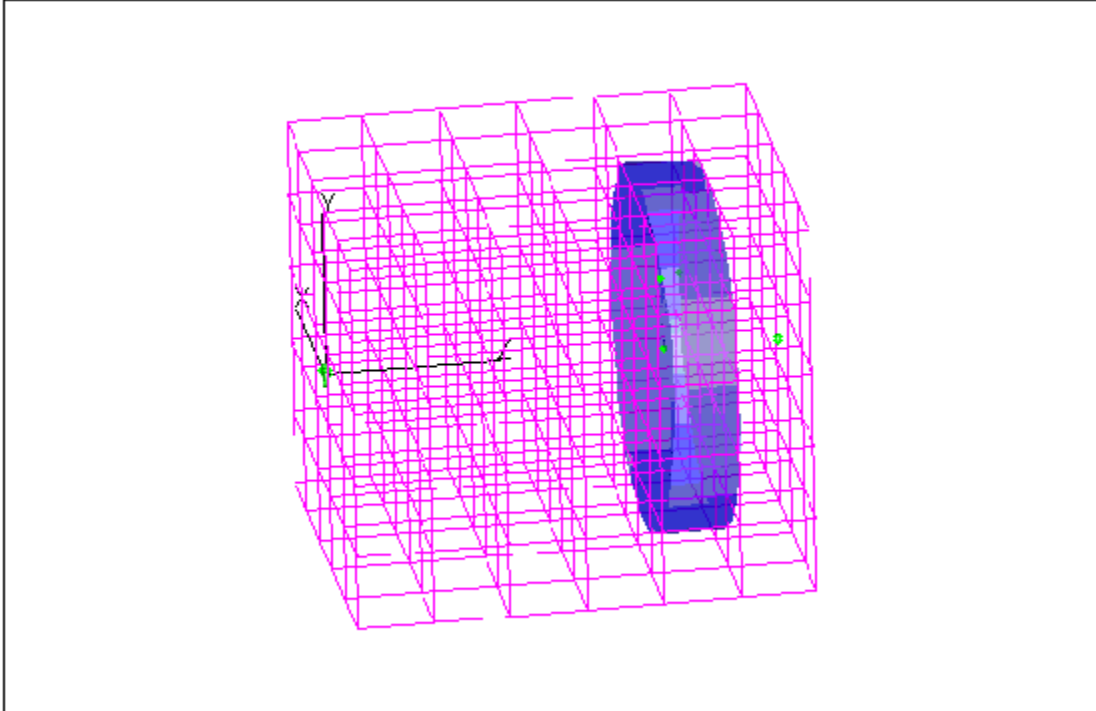

FIGURE 5.34 - Uniform Voxels for a simple telescope.

Octree voxels

If your model is very spread out with large regions of empty space, you may see an increase in ray-trace speed by choosing octree voxels. Octree voxels are created recursively. TracePro starts with one voxel containing all the geometry in your model, then subdivides it into eight octants, or voxels, using three dividing planes. Each of these smaller voxels can be subdivided as well, and so on until criteria determined by the voxel parameters are met, creating a tree-like structure of voxels. Where there are more surfaces, edges, and facets, more subdividing will take place. This technique creates more voxels where they are needed, and fewer voxels where there is empty space. The **Maximum Tree Depth** determines the maximum number of times voxels can be subdivided. A usual number to use for this is in the range of two to six. The maximum number of voxels created is on the order of 8^N , where N is the maximum tree depth. For example, with $N=2$, no more than about 64 voxels will be created, while for $N=6$, no more than about 262,144 voxels will be created. Octree voxels use more memory per voxel than uniform voxels, with each voxel requiring at least 56 bytes, so with $N=6$, there may be 14MB or more of memory consumed. Also, empty octree voxels are slower to traverse than uniform voxels.

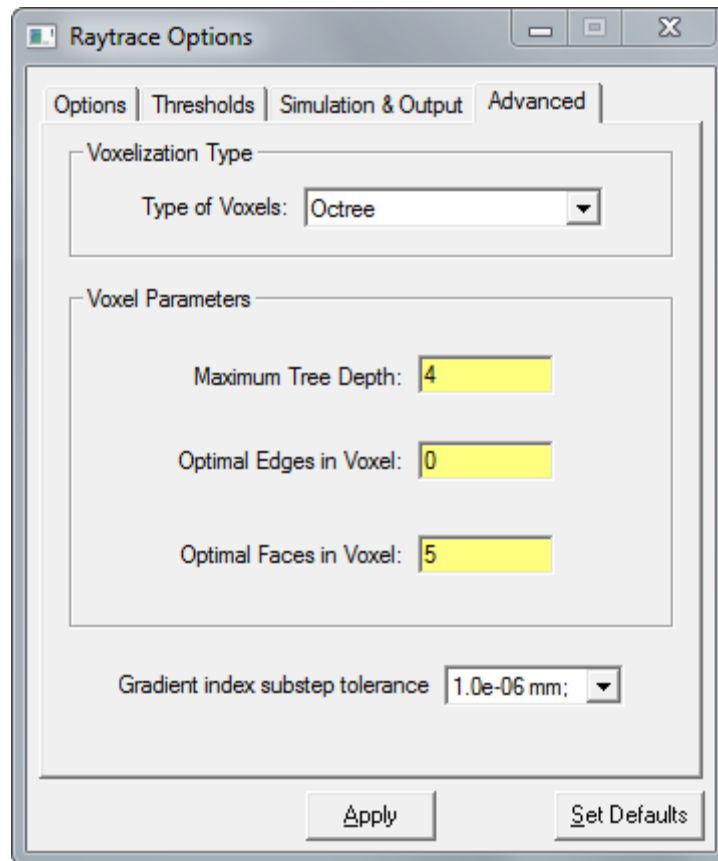

FIGURE 5.35 - Advanced Tab (Octree Options)

The Optimal settings are criteria for TracePro to create more voxels. TracePro will create more voxels during the audit until all of these criteria are met or until the **Maximum Tree Depth** is reached. The **Optimal Edges in Voxel** and the **Optimal Faces in Voxel** settings are maximum number targets, so voxel subdivision will continue until these numbers are reduced to equal or less than the numbers entered. In normal usage, you will not need to change these settings. Figure 5.36 shows Octree voxels generated for the simple telescope shown in Figure 5.34. The optical elements are widely spaced and you can see how few voxels are created between the elements while many are created close to surfaces and edges.

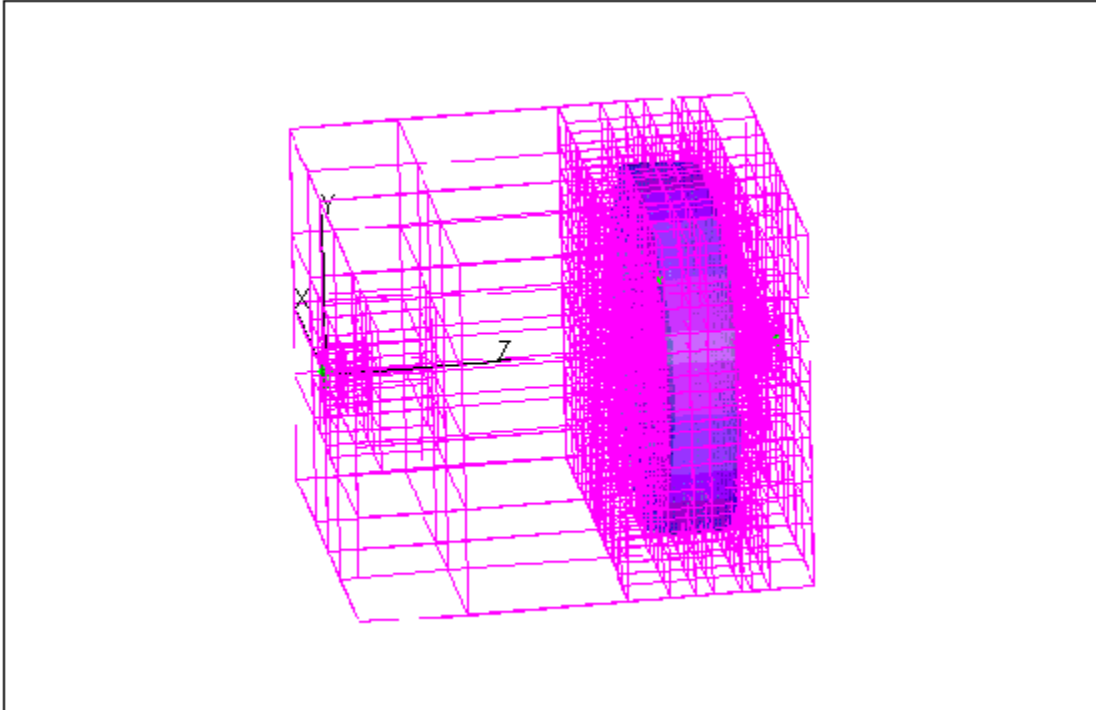

FIGURE 5.36 - Octree Voxels for a simple telescope.

Ray tracing and spline surfaces

When you import a model from another CAD program, some of the surfaces may be NURBS or spline surfaces. If you expand each surface in the system tree, the type of surface is displayed. In general, any surface that is not a primitive surface type is a spline. The primitive surface types in TracePro are Plane, Sphere, Cone, and Torus. For example, if a surface was parabolic or elliptical in the CAD program, it will be exported as a spline. If a surface is created as a Parabolic Reflector in TracePro, it is represented as a paraboloid of revolution while in TracePro but will be exported as a spline. Therefore, a parabolic reflector that is created in TracePro will be ray-traced much faster than one created in a CAD program and imported into TracePro. Finally, if you create, for example, a parabolic reflector in TracePro and alter it by a Boolean operation, it will become a spline. In this case the ray-trace speed will slow somewhat.

You may be able to convert some of the spline surfaces to primitive surfaces if they started as primitive surfaces but were changed to splines by the CAD program as it exported the file. This may happen depending on the originating CAD program and the settings that were in place when the file was exported.

Gradient Index Substep Tolerance Standard Expert

The *Gradient Index Substep Tolerance* lets you trade-off accuracy vs. speed while tracing rays through an object with a *Gradient Index* property on it. TracePro uses an adaptive stepping algorithm. Each substep takes a curved trajectory through the gradient index material. The length of the substep is a function of many variables including the gradient index profile in the local region of the material and

the user-supplied substep tolerance. As the ray proceeds through the material, optical position and optical path errors are not permitted to exceed this tolerance. When this tolerance is met, a new substep is created. A smaller tolerance will improve accuracy at the expense of raytrace speed, while a larger tolerance will speed up the raytrace at the expense of accuracy. The optimal setting depends on the specific characteristics of your model. You should experiment with different settings for a particular model to determine the optimal setting.

Ray Tracing modes

TracePro allows you to select different modes for storing rays during the raytrace. These are selected by checking one of the checkable items at the bottom of the **Raytrace** menu. You can choose either **Analysis Mode** or **Simulation Mode**. This allows you to trade off the amount of information that is available versus the amount of memory that is consumed. Analysis Mode generates more ray data but consumes more memory, while Simulation Mode generates less data and consumes less memory. To activate one or the other of the choices, simply check one of the items before beginning the raytrace. If you choose Simulation Mode, you will have to specify an exit surface before the raytrace starts if you wish to see an irradiance map after the raytrace is completed. TracePro will not allow the raytrace to be done and will warn the user if an exit surface has not been specified

Analysis Mode

In an Analysis Mode raytrace, TracePro saves all of the ray data that is generated during the raytrace. This allows you to view the irradiance on any surface in the model after the raytrace is completed. To do this requires a large amount of memory. The more ray splitting that takes place for each ray and the more surface intercepts that rays undergo before they are terminated, the more memory is required for each starting ray. A raytrace started with many rays (tens or hundreds of thousands or more) and with many ray-surface intercepts for each ray can require hundreds of megabytes of memory.

TracePro allocates memory as needed during the raytrace by requesting memory from Windows. Initially, your physical RAM will be used. If all the physical memory is used, the operating system will allocate memory from virtual memory. Virtual memory is disk space that is used like physical memory. Accessing virtual memory is much slower than accessing physical memory, so if TracePro is doing a raytrace that requires a large amount of memory, the progress of the raytrace will slow as it begins to use virtual memory. If all available virtual memory is used up, TracePro will discontinue the raytrace. You can increase the amount of virtual memory available from the Windows Control Panel, as your available disk space permits. If you are not comfortable doing this yourself, you should seek the help of a system administrator or other expert.

You can increase the amount of physical memory by installing more RAM in your computer. The maximum RAM that can be used is 8TB, although only a fraction of that can be accessed by Windows (128GB for Vista, 192GB for Windows 7, 128GB for Windows 8 and 10, 512GB for Windows 8 and 10 Professional and Enterprise). Many Windows Server editions can access 4TB of RAM. See microsoft.com for the most current information.

To perform an analysis mode raytrace, select the **Analysis Mode** item at the bottom of the **Raytrace** menu. If there is a \checkmark next to the **Analysis Mode** item, TracePro is already in Analysis Mode. After the raytrace is complete, you will be

able to examine the irradiance at any surface. You will also be able to display candela plots.

Saving and Restoring a Ray-Trace

An analysis mode raytrace can be saved to disk for later display. To do this, first put TracePro into Ray Saving Mode by selecting **File|Save Ray Data**.

This action toggles the Save Ray Data menu item on and off. When the menu item is checked and you save a TracePro model, a second file with the extension **ray** is also saved. The ray file contains data for all the rays from the most recently completed raytrace.

To save ray data, first be sure that TracePro is in ray saving mode. You can check this by looking at the File menu and confirming that the **Save Ray Data** item is checked. (If there is a ✓ next to the menu item, it is checked. Selecting it again makes it unchecked.) Then select **File|Save As** and type in a file name for the **oml** file. Press Save to save the file, and TracePro will save both the **oml** file and the **ray** file.

It is important that the **oml** file and **ray** file stay synchronized. Changes to the geometry and properties in the **oml** file will make the saved rays obsolete and unrepresentative of the model. Therefore, you should not change the model unless you are planning to re-do the raytrace. If you wish to keep a progression of models with their associated ray data, save the OML file to a new name using **File|Save As** with the menu option **File|Save Ray Data** checked on.

To restore a saved raytrace, simply open an **oml** file that has an associated **ray** file. TracePro will find and open the ray file at the same time, and display the rays (providing the **Analysis|Display Rays** menu item is checked). Once the rays are restored, you can sort them using **Analysis|Ray Sort** and display irradiance maps and Candela plots.

Simulation Mode

In Simulation Mode, only a small amount of ray data is saved during the raytrace. This allows you to trace many more rays before virtual memory is used or before all memory is used. Thus you can do raytraces with much larger numbers of rays in Simulation Mode than in Analysis Mode. However, since much less ray data is saved for a Simulation Mode raytrace, you do not have the flexibility of displaying irradiance for any surface after the raytrace is completed.

Before you begin a raytrace, you must select one or more Exit Surfaces for which ray data will be saved during the raytrace or the option to save Missed Rays Candela Data. During the raytrace, only the segments of the rays that are incident on the defined Exit Surfaces and/or Missed Rays Candela Data rays will be saved.



The exit surfaces can be any surface in the model. To select an exit surface, first select **Edit|Select Surface** or press the *Select Surface* button on the toolbar to go into surface selection mode. Then select **Define|Apply** to open the Apply Properties dialog box, and press the Exit Surface tab. Select the surface that you wish to be the exit surface either graphically or using the System Tree. This surface is the one for which you will be able to display irradiance maps. Finally, check the Exit Surface check box and press Apply.

Simulation Dialog

After the raytrace is started, a dialog is displayed to confirm that the proper data will be collected. The dialog prompt is optional but is defined to be active by default. To disable/enable the prompt, use `View|Options|View`.

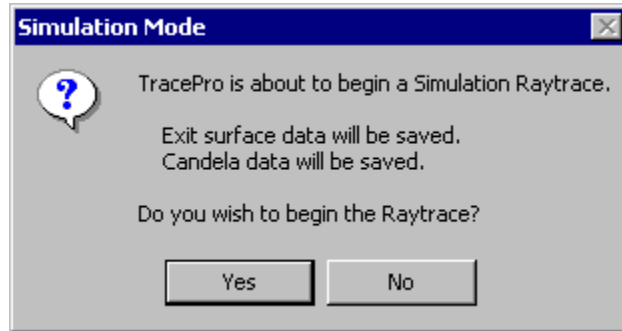

FIGURE 5.37 - Simulation Prompt.

When data is being saved to SIM files, an entry for Notes is provided. See “Index file name” on page 5.48

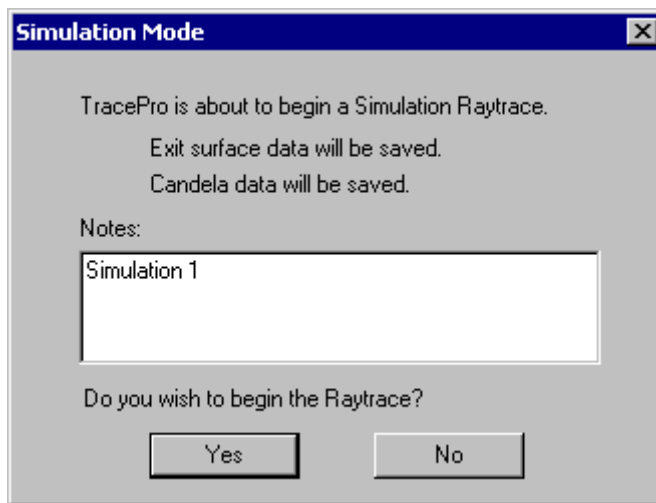

FIGURE 5.38 - Simulation Prompt when data is being saved to a file.

Simulation Options Standard Expert

In order for TracePro to save data during the raytrace, you must indicate whether you want to save exit surface data, data for candela plots, and/or data for Path Sorting. Do this by selecting `Raytrace|Raytrace Options`. The Simulation & Output tab lets you choose what type of data will be saved during the raytrace. You can choose any of these features independent of the others. You must check the appropriate box or boxes before performing the raytrace in order to be able to view the results after the raytrace is finished.

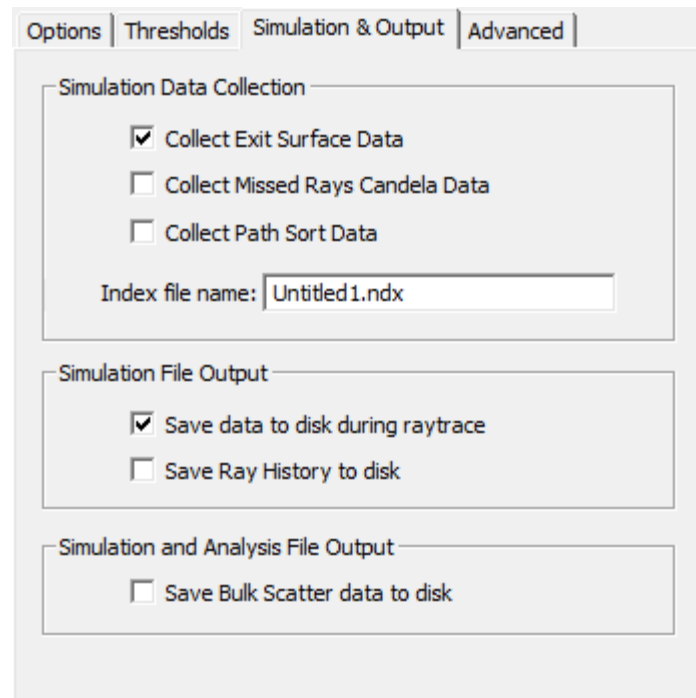

FIGURE 5.39 - Raytrace Options dialog box for TracePro Standard and Expert.

The *Save data to disk during raytrace* option stores data for an irradiance plot to a binary file on disk. No RAM is used to collect the Exit Surface data. See the online help for details on the use and limitation of this option. See “Index file name” on page 5.48

Three output text files can also be generated during the raytrace, and the *Save Bulk Scatter data to disk* option can be used in Analysis and Simulation modes.

When the *Save Ray History to disk* option is enabled,

- A ray history table for the Exit surface is generated and saved into a text file for the model. See “Ray Histories” on page 6.55
- The file name is formed by appending “-rayhistory.txt” to the model name.
- The format is identical to an exported ray history from analysis mode. See “Saving the Ray History Table in a File” on page 6.57

When *Collect Path Sort Data* is enabled, a set of ray paths absorbed at the Exit surface(s) is generated and saved into a text file for the model. The file name is formed by appending “-raypaths.txt” to the model name. Each ray path is unique, such that any two paths are considered the same if the sequence of the surface intersections and intercept type of each intersection is identical. The output file lists the number of paths, the flux in each path and the intersection order with intercept type and surface name. The list is sorted in descending order of flux absorbed by each surface. Ray paths are used in stray light analysis and are very useful for ghost ray identification.

When *Save Bulk Scatter data to disk* is enabled, a set of positions and flux values for each bulk scattered ray is generated and saved into a text file for the model. The file name is formed by appending “-scatter.txt” to the model name. The object in which the scatter occurred is also listed.

NOTE: This option is also available during analysis mode.

Simulation Data for LC LC

The *Collect Exit Surface Data* and *Collect Missed Rays Candela Data* options are found on the Options tab in TracePro LC.

Optimization Standard Expert

TracePro has two methods of optimization available in the Standard and Expert editions. Each optimization function is bundled in a separate application that communicates with, and drives the TracePro ray-trace engine via scheme commands. Each optimization function is self-contained and has its own help system. The optimizers are designed to be very interactive and intuitive to use. Optimizers are accessed via the **Optimize** menu selection

Interactive Optimizer

The Interactive Optimizer is a utility for designing and optimizing reflectors and lenses for illumination applications. It is particularly useful for designing LED lenses, but it can be used for other applications. Using the Interactive optimizer, you can define an analytic or spline surface, then specify variables and a target, and the optimizer will vary the design to meet the target. When specifying a spline surface, the control points of the surface can be made variable in three dimensions. You can also create a starting design by pulling on control points with the mouse, with rays updating automatically as you change the design.

LC **Note for TracePro LC:** In TracePro LC, the Interactive Optimizer is named Interactive Modeler, and is located on the **Geometry** menu. It enables you to sketch profiles of geometrical objects, but you cannot optimize them.

The Interactive Optimizer has its own help system.

Texture Optimizer II

The Texture Optimizer II helps you optimize structured Liquid Crystal Display (LCD) backlight components including Brightness Enhancement Films (BEFs), Turning Films, and extraction features in light guides. With a TracePro model of the LCD, the utility generates a Textured pattern of geometry on any surface, optimized for uniformity or flux.

The Texture Optimizer II has its own help system.

Examining Raytrace Results

After a raytrace you need to assess the data that results from it. The Analysis menu provides several ways to view raytrace data. Displaying Rays and Ray Sorting let you view the ray data. Irradiance Maps, Ray Tables and Polarization Maps provide ray results for each surface in the Model if within Analysis mode and on Exit Surfaces in Simulation mode. Candela Plots display angular distributions of ray data in the Model. The Volume Flux Viewer can provide insights into the flux distribution within Model objects.

A variety of Reports are available to help you analyze the ray data and Model properties from the Reports Menu.

The Tools menu includes additional features to improve the raytrace results.

Analysis Menu

Most raytrace results are accessible from the Analysis Menu and are described in this chapter. Ray Tracing is also initiated by menu items contained in the Analysis menus and are described in Chapter 5.

Display Rays



The **Anal ysi s |Di spl ay Rays** selection allows you to control the display of rays. In Analysis Mode, rays are displayed by default after a raytrace is finished or canceled. Rays cannot be displayed in Simulation Mode. To turn off the display of rays, simply select **Anal ysi s |Di spl ay Rays**. The state of Display Rays is indicated by the check mark next to the menu item. If many rays have been traced with many splits or “branches,” it can take several minutes for TracePro to finish displaying the rays. You can set TracePro to update the display of rays only at your request by de-selecting **Wi ndow |Auto Update**. Then the display of rays will not be updated until you press F5 or select **Wi ndow |Refresh**. Rays may also be timed during the drawing process with the limit set as a preference. See “Ray Display” on page 2.59.

You can also affect what rays are displayed using **Ray Sorti ng** as described below.

Ray Colors

The Ray Colors dialog box (Figure 6.1) provides four ways of controlling ray colors:

- Flux-based ray colors
- Wavelength-based ray colors
- Source-based ray colors
- All rays one color

Any color can be changed by clicking on its color bar, which opens the Windows standard color palette.

Flux-based ray colors

There are three default color palettes for monochromatic ray flux display. Along with the Default Red-Green-Blue coloring, there are Extended and Logarithmic palettes which include 10 different levels. Each of these may be modified to use different colors for the various levels, change the relative crossing points of each level, and add new levels.

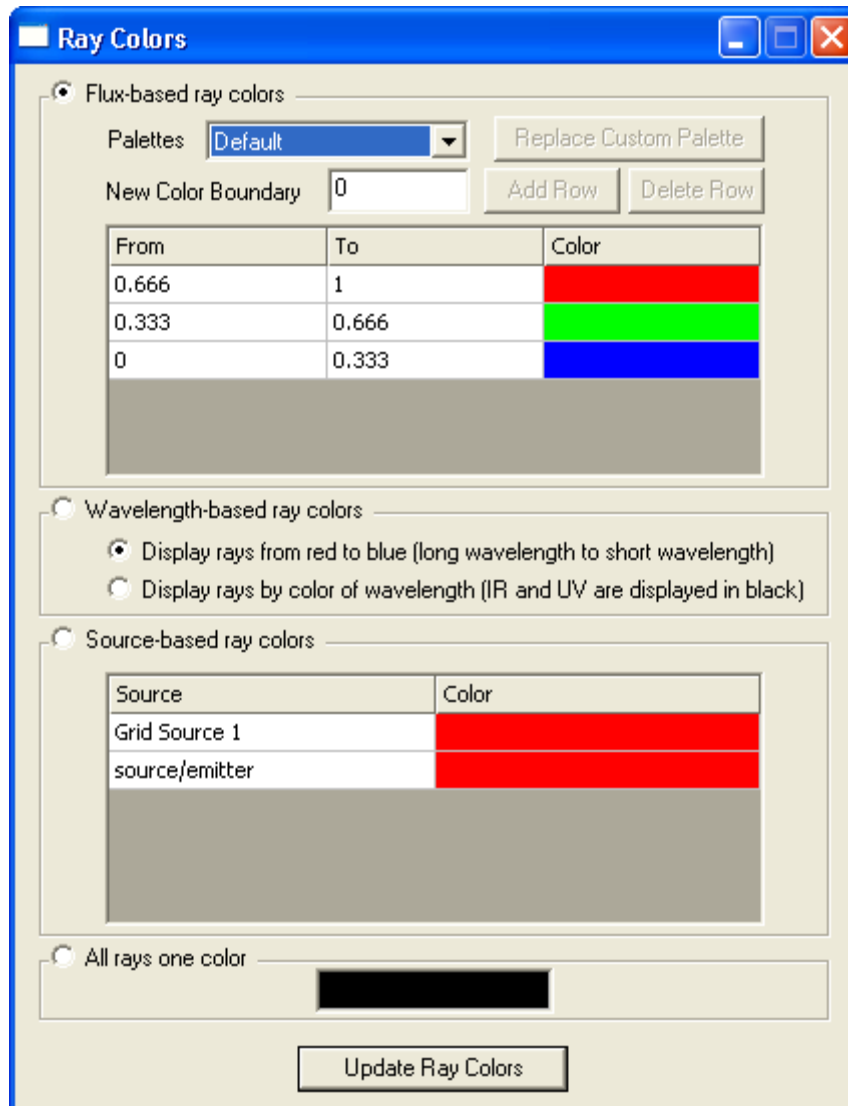

FIGURE 6.1 - Ray Colors dialog box

To change the color palette

1. Open the Ray Colors dialog using the **Analysis | Ray Colors**
2. Select the Desired Palette
3. Press Update Ray Colors

To create a Custom palette

1. Open the Ray Colors dialog using **Analysis | Ray Colors**

2. Select the Desired Palette to modify
3. Add crossover points using the Add Row button by entering a value in the New Color Boundary box
4. Delete crossover points by selecting a row and pressing the Delete Row button
5. Change the ray color by clicking in the Color cell and selecting the new color from the Color Picking dialog
6. Press the Replace Custom Palette button
7. Press Update Ray Colors

Note: the Custom Color Palette will be stored in the OML file.

Wavelength-based ray colors

This section of the Ray Colors dialog box allows you to display the rays in either of:

- Red to Blue (false color)
- Color of wavelength (non-visible wavelengths in black)

With Red to Blue (false color) coding, rays will be colored in descending order of to wavelength from red to blue (long to short wavelengths). With Color of wavelength coloring, the color of each wavelength, according the CIE 1936 standard, will be used to display the rays for that wavelength.

Source-based ray colors

This section uses the color of each source to color the rays. The source color can be changed by clicking on the color bar and selecting a new color. The color can also be changed in the source definition.

All rays one color

You can choose to have all rays displayed in the same color. The default color is black. You can change the color by clicking on the color bar.

Path Sort Table

The Path Sort Table selection opens a window to display unique ray paths reaching the selected surface. A unique ray path is one that has a unique combination of surfaces and intercept types along the path of the ray. The columns include the number of rays along the path, absorbed flux, and incident flux. You can sort the table by column in descending order by clicking on the column header. Clicking on the header a second time sorts the table in ascending order. Individual paths can be expanded to show the detail of the path, including surfaces intersected and the intercept type at the intersection. To expand a path, double-click on the + next to the path number. You can right-click to open a pop-up menu with more Expand and Collapse options.

To display the rays for one or more paths in the Model Window, select the desired paths by clicking on row number(s), using Shift- or Ctrl-click for multiple selections, then select **Analysis | Display Selected Paths**. In **Analysis Mode**, all of the rays of the selected paths are displayed. In **Simulation Mode**, only the first ray of each of the selected paths is displayed. If the Irradiance/Illuminance Map window is also open, the map will be updated to include only those selected paths.

The Display Selected Paths feature takes priority over the Display Selected Rays feature. This means that if the Display Selected Paths feature is turned on, the Display Selected Rays feature will be disabled, and its menu selection will be displayed in gray to indicate that it is not available.

You can save the table as a text file by selecting **F I l e | Save As** when the Path Sort Table is the active window.

Simulation Mode

In simulation mode, path sorting must be enabled before the raytrace begins by selecting **Collect Path Sort Data** in the Raytrace Options dialog box, Simulation & Output tab.

Analysis Mode

In Analysis Mode, path sorting is always available by choosing **Anal ysi s | Path Sort Table** after the raytrace is complete.

Memory Consumption

Path Sorting may require a large amount of memory to store the paths. Complicated models may generate tens or hundreds of thousands of paths, requiring several GB of memory. If your model requires more memory for path sorting than is available on your computer, you will not be able to use path sorting.

The figure below shows a Path Sort Table with path 1 expanded.

Ray Path	Source	Wavelength	No. Rays	Absorbed ...	% of Total	Incident Flux	% of Total	Path Type	No. Intercepts	No.	Intercept Type	Object	Surface
1	Arc/Cyl	0.5461	69639	0	0.00	5.99647305004475	82.07	Specular	5				
										1	Emitted	Arc	Cyl
										2	SpecTran	Quartz bulb	Inside sphere
										3	SpecTran	Quartz bulb	Outside sphere
										4	SpecRefI	Reflector	Inside
										5	At Surface	Observation Disk	Front
2	Arc/Cyl	0.5461	3232	0	0.00	0.0440050114173641	0.60	Specular	7				
3	Arc/Cyl	0.5461	5287	0	0.00	0.222253544310861	3.04	Specular	8				
4	Arc/Cyl	0.5461	4048	0	0.00	0.0442905905630199	0.61	Specular	10				

FIGURE 6.2 - Path Sort Table

Path Sort Table Settings

Path Sort Table settings enable you to customize the filtering of paths according to your needs. You can filter by source, wavelength, number of intercepts along a path. You can also choose the percent of rays to display, or make custom filters to further control the table. The settings are summarized in Table 6.1.

TABLE 6.1. Path Sort Table Settings

Sources	Select from the list which sources you wish to be included in the Path Sort Table.
Wavelengths	Select from the list which wavelengths you wish to be included in the Path Sort Table.
No. of intercepts	Filters the paths by the total number of ray-surface intercepts along a path. Enter intercepts and/or ranges of intercepts separated by commas. For example: 5-8,10,12
% of rays to display	When Analysis Display Selected Paths is checked, this entry controls the percent of rays matching the selection that will be displayed.
Filter Editor	Opens the Path Sort Filter Editor window that allows you to define one or more filters for refining the path sort table.
Select filters	Apply one or more filters to the path sort table by using the checkbox for each filter.
Apply	Applies all the settings to the path sort table.

Path Sort Filter Editor

The Path Sort Filter Editor allows you to refine the path sort table by selecting which surfaces or objects must (or must not) be intersected by rays along the path. Surfaces and/or objects matched with intercept types can be combined together using Boolean AND and OR operators.

To edit filters, click the Filter Editor button in the Path Sort Table window. The Filter Editor window is shown in Figure 6.3. The meaning of each selection is summarized in Table 6.2.

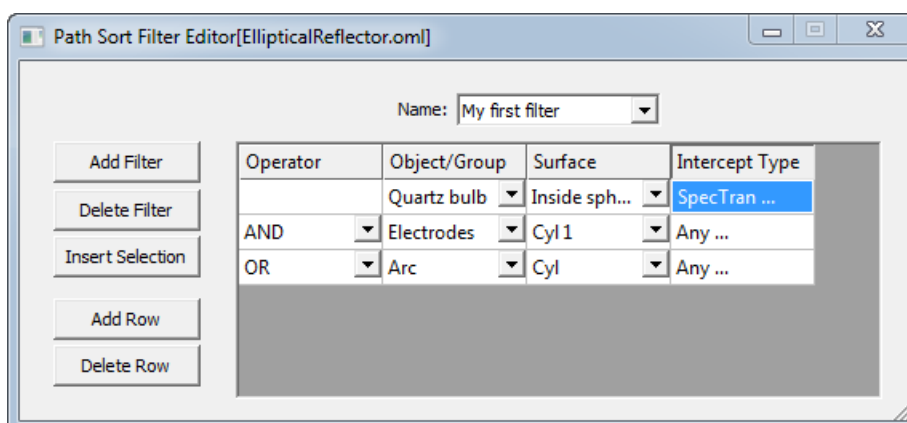

FIGURE 6.3 - Path Sort Filter Editor

TABLE 6.2. Path Sort Filter Editor items.

Name	Choose the name of the filter you wish to edit from the list.
Add Filter	Add a new filter for use by the current model's Path Sort Table.
Delete Filter	Delete the current filter.
Insert Selection	Add new row(s) to the filter, one row for each surface, object, or group selected in the Model Window for the current model.
Add Row	Add a (blank) row to the current filter.
Delete Row	Delete the selected row(s) in the current filter.
Operator	Select a Boolean operator (AND or OR) to be used to combine the result of the current row with the result of the previous row(s).
Object/Group	Select an object or System Tree Group to be used in the current filter row.
Surface	Select a member surface of the selected Object/Group. Select <Any> to indicate that a ray intersecting any member surface of the object or group can satisfy the test. For bulk scatter intercept types (RandVolume or ImpVolume), the Surface selection is ignored.
Intercept Type	Open the Intercept Types window for selecting intercept types for the current row.

Path Sort Filter Intercept Types window

To select which Intercept Types are used for the current row, click on the Intercept Type cell for the desired row to open the Intercept Types window as shown in Figure 6.4. You can select as many specific intercept types as you wish, and they will be used in the current row of the filter.

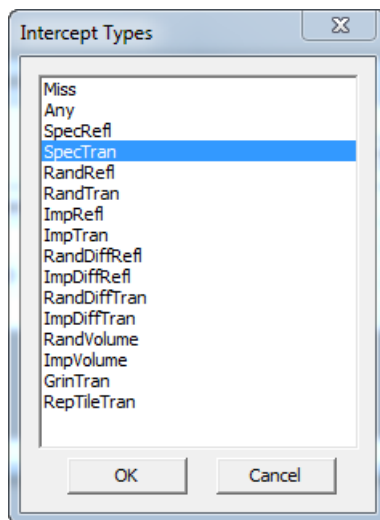

FIGURE 6.4 - Path Sort Filter Intercept Types

Miss

Select Miss to specify that all rays must miss the selected surface(s) in order to pass the filter. Selecting Miss will clear all other Intercept Type selections.

Any

Select Any to specify that a ray of any intercept type will pass the filter. Selecting Any will clear all other Intercept Type selections.

Irradiance Maps

Irradiance or illuminance maps can be viewed by selecting **Analysis | Irradiance Maps**. An irradiance map will be displayed showing irradiance incident on the currently selected surface. If the surface is not a plane, the irradiance will be projected onto a plane. The orientation of the projection plane is controlled in the irradiance Options dialog box accessed from **Analysis | Irradiance Options**, or by right clicking in the Irradiance Map window and selecting Irradiance/Illuminance Options... Other settings, as described below, are controlled within this dialog. The map can be displayed in shades of gray with white being the highest irradiance and black being zero irradiance, vice versa, or in one of a selection of false color palettes.

The orientation of the irradiance map is determined by the Normal Vector and the Up Vector, as specified in the **Analysis | Irradiance Options** dialog box. The normal vector is normal to the projection plane on which the map will be displayed, and the up vector determines which side of the map will be at the top of your screen. The normal vector can be defined to point out from or into an object. Reversing the direction will cause the image to be flipped from left to right. If, upon displaying the irradiance map, it seems nonsensical, check the orientation of these vectors. You can have TracePro choose the Normal and Up vectors by clicking *Automatically calculate Normal and Up Vectors*. Click *Apply* to update the display.

An irradiance map is the irradiance in watts per unit area or lux, incident or absorbed on the selected surface. The irradiance map will appear noisy if an insufficient number of rays is traced. The noise and the blockiness of the pixels can be smoothed by selecting Smoothing in the Irradiance Options dialog box, with a corresponding reduction in resolution. The only cure for noisy results is more rays per pixel. You can create more samples either by increasing the number of rays started, or increasing the number of random rays and importance sampled rays generated when you are simulating scattered light.

Irradiance Map Options

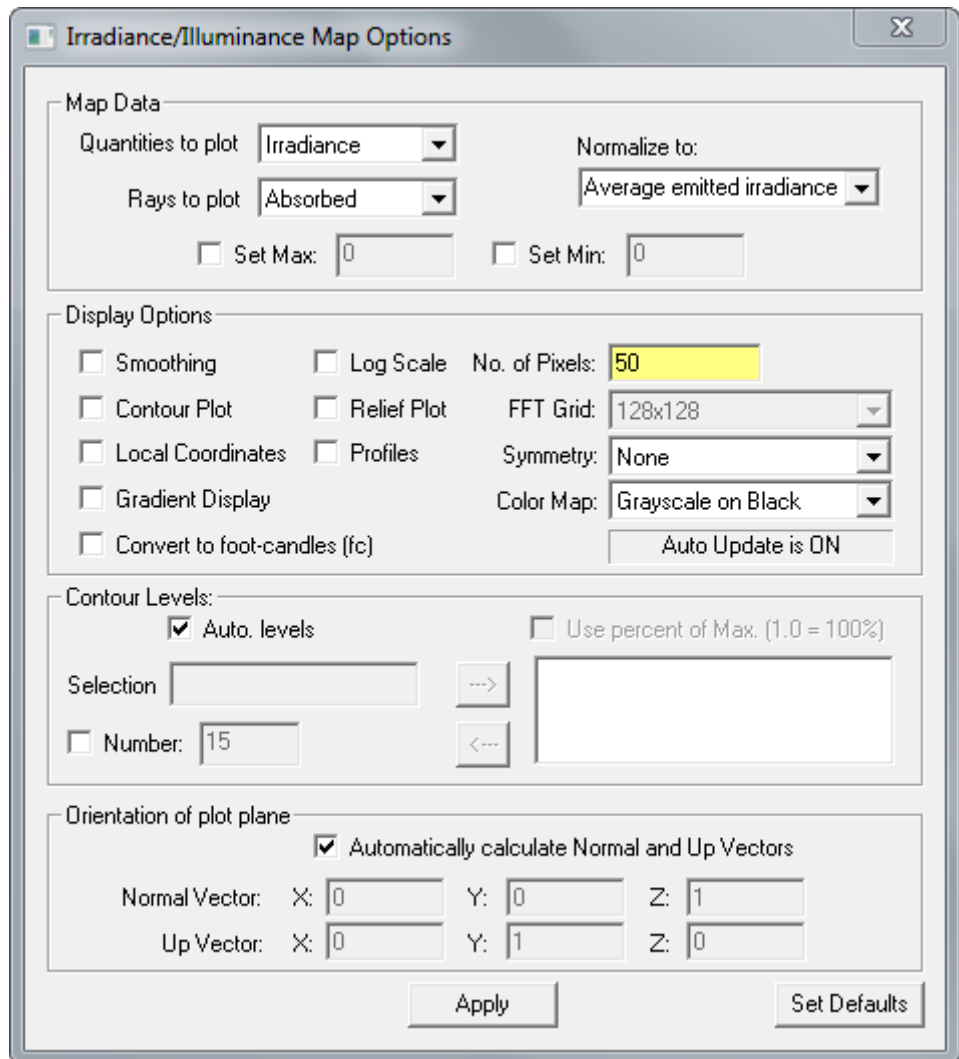

FIGURE 6.5 - Irradiance Options dialog box

Irradiance map options are controlled through the Irradiance Options dialog box, accessed by selecting **Analysis | Irradiance/Illuminance Options...** or by right-clicking on the irradiance map and selection **Irradiance/Illuminance Options...** from the context menu. Each option and its function are described in the sections that follow.

Map Data

The Map Data defines what quantities are displayed in the plot.

Quantities to Plot

Selects the map type to display. You can choose from:

- Irradiance, a plot of power per unit area of radiation incident on or absorbed by a surface,

- CIE (x, y), a plot of color in CIE xy coordinates,
- CIE (u',v'), a plot of color in CIE u'v' coordinates,
- True Color

When you display either a CIE xy or u'v' plot, a plot of the color of the light incident on the surface is displayed, at full brightness. In addition, a CIE diagram is displayed next to the surface plot. When you roll the mouse cursor over the surface plot, a small circle is displayed at the xy or u'v' coordinates, and the Correlated Color Temperature (CCT) is displayed above the circle. The xy or u'v' values are also displayed in the Status Bar at the bottom of the TracePro application window.

Rays to Plot

You can observe a map of absorbed, incident, or exiting rays. Incident irradiance maps can be misleading when the selected surface is hit several times by the same ray. For example, a surface between two infinite parallel mirrors would have the same ray intersect the surface until the ray fell below the flux threshold or intercept threshold, generating an incident flux many times greater than the starting flux of the ray. Exiting ray irradiance maps can also be misleading for the same reason. In addition, take care that you do not interpret an exiting ray irradiance map as the appearance of the surface. To display the appearance of surfaces, use the Luminance Map.

Normalize to

Normalize the map data according to the selection. The choices are *None*, *Average emitted irradiance*, *Peak irradiance*.

This option allows you to have the irradiance map normalized. The footer of the maps always displays the total flux in the map as well as the flux divided by the total emitted flux. If you select *None*, and the raw irradiance values will be displayed.

Example 1: System Transmittance

Suppose you need to calculate the system transmittance of an optical system. You would probably use the grid raytrace option, and the emitted flux is equal to the sum of the flux in all the emitted rays. When you display an irradiance map, the system transmittance is equal to the total flux, displayed at the bottom of the irradiance map window, divided by the emitted flux. To get the system transmittance, simply read the "Flux/Emitted Flux" value on the footer of the map.

Example 2: Lighting Efficiency

Suppose you need to calculate the lighting efficiency of a luminaire in illuminating a plane. You would probably choose the Surface Source raytrace option, and the emitted flux is equal to the flux you specified when you defined the sources. When you display an irradiance map, the total flux incident on the observation plane is displayed at the bottom of the window. The lighting efficiency is equal to the total flux divided by the emitted flux. You can get this number simply by reading the "Flux/Emitted Flux" value on the footer of the map.

Example 3: Point Source Transmittance

The Point Source Transmittance or PST is commonly used as a measure of stray light in imaging systems. It is defined as the irradiance at the image surface

divided by the incident irradiance from a point source. To calculate PST, first define a collimated Grid Source (i.e. Uniform or Lambertian with half-angle equal to zero). After performing the raytrace, select Normalize to Average emitted irradiance and display the irradiance map. The units will be $(W/m^2)/(W/m^2)$, which you can interpret directly as PST.

If Quantities to Plot is set to True Color, the *Normalize to:* options change to *None*, *Highest Color*, and *Exposure Level*. Selecting *Highest Color* will normalize the displayed color value in the plot. Selecting *Exposure Level* will normalize the plot to display a saturated white color, even if the plot is monochromatic. For example, with green light the saturated values would be (0,255,0).

Set Max/Min

The Max/Min values provide thresholds for the plot scale. If a Max value is set it will be used for the maximum value used in the irradiance plot. Any values which exceed the Max value will be displayed at the Max value. The Min value works in the same manner. If the Log Scale is set the Min value is disabled.

Display Options

The display options control the plot output.

Smoothing

If the smoothing box is checked, the irradiance distribution will be smoothed using a Gaussian smoothing kernel of the form

$$K(x, y) = \frac{1}{2\pi\sigma^2} e^{-(x^2+y^2)/(2\sigma^2)}, \quad (6.1)$$

where σ is the waist radius of the Gaussian, taken as the width of the map divided by the *No. of Pixels* value. For example, the default value of 50 means that the waist radius of the kernel is 1/50 of the width of the map.

The smoothing is done by convolving this kernel with the irradiance distribution,

$$E_{\text{smooth}}(x, y) = \iint E(x', y') K(x - x', y - y') dx' dy' \quad (6.2)$$

The convolution is done by Fourier transforming, applying a filter, and inverse Fourier Transforming.

Contour Plot

Selecting Contour Plot creates a topographic map of the irradiance. Smoothing is always turned on when you select Contour Plot. The number of contours and contour levels is described in the Contour Levels section below.

Local Coordinates

The corners of the plot are labeled with coordinate data for the selected surface. By default the corners are labeled in global X, Y, Z points. Checking this item will display the corners in local X, Y coordinates.

Gradient Display

Checking this box causes a continuous gradation of colors to be displayed instead of discrete contours.

Convert to foot-candles

Scales plotted values to foot-candles.

Log Scale

Checking this box displays the irradiance on a logarithmic scale. This is especially useful when you need to see details in the very lowest irradiance values. This might be needed, for example, in a stray light analysis.

If you check Logarithmic Scale and Smoothing at the same time while also selecting a large number for Map Count (greater than 40), you can see artifacts in the display of the irradiance map in the form of cross-shaped patterns surrounding sharp peaks in the pattern. This is a result of aliasing and should be ignored.

Relief Plot

This option produces a 3D relief plot using OpenGL. See Figure 6.7 on page 6.13.

Profiles

Checking this box causes cross-sectional plots of the Irradiance/Illuminance to be displayed. When you press Apply, additional plots are shown that contain the profiles. To change the axes of inspection for the Profiles option, click a different point in the Irradiance/Illuminance map. A new set of horizontal and vertical axes are set at this point, and they are displayed in the profiles area of the window. Each profile passes through the point you selected with the mouse. Each time you select a new point, the display is updated. Clicking a point outside the Irradiance/Illuminance map (but still inside the Irradiance/Illuminance map window) causes the profiles to become blank. To remove the profiles altogether, uncheck the Profiles check box and press Apply. See Figure 6.6 on page 6.12.

The vertical axis of the profile plot corresponds to the Irradiance/Illuminance scale. The horizontal axis corresponds to the linear size of the plotted area where the left hand side of the plot shows the position of the left side of the horizontal cursor line and the bottom position of the vertical cursor line. Two profile plots are drawn for the two cursor lines displayed.

No. of Pixels

The *No. of Pixels* value determines the resolution of the display on the irradiance map. The value is the number of pixels in the irradiance map *in both the horizontal and vertical directions*. TracePro displays a square irradiance map and square pixels. When Smoothing is enabled the *No. of Pixels* value is used to control the degree of smoothing applied to the data.

FFT Grid

Sets the size of the data grid for smoothing. The smoothing uses a Fast Fourier Transform (FFT) which requires a grid size of a power of 2. This value is also used to set the number of pixels in the irradiance map when it is saved as a text file with smoothing turned on.

Symmetry

Using this option you can take advantage of known symmetry on an irradiance or illuminance map. A smoother distribution can be obtained from fewer rays. The five symmetry selections are:

- None - This is the default where no symmetry is applied.

- Left / Right - Symmetry is applied between the left and right halves of the map.
- Up / Down - Symmetry is applied between the upper and lower halves of the map.
- Quadrant - This is the combination of Left / Right and Up / Down symmetry.
- Rotational - Symmetry is applied about an axis perpendicular to the center of the map.

The symmetry selection should be used with caution. TracePro will force symmetry onto the irradiance/illuminance map even if your model does not possess symmetry. The user, through this option, conveys to TracePro that the data being plotted actually has the selected symmetry. This option should be used with caution, and only for evaluating intermediate results. For final results, select Symmetry None and be sure you have traced enough rays to accurately predict the irradiance or illuminance.

Color Map

Use this drop-down list to opt for either grayscale or one of several color-coded schemes. The choice of color affects both the display and the contour map display.

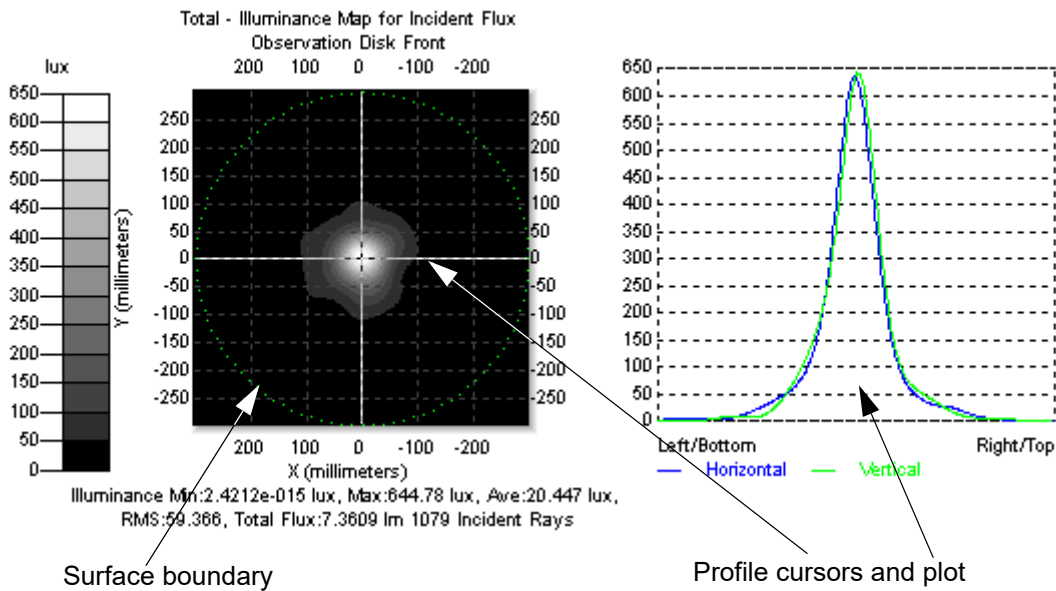

FIGURE 6.6 - Irradiance Map with Profiles for Elliptical Reflector Demo

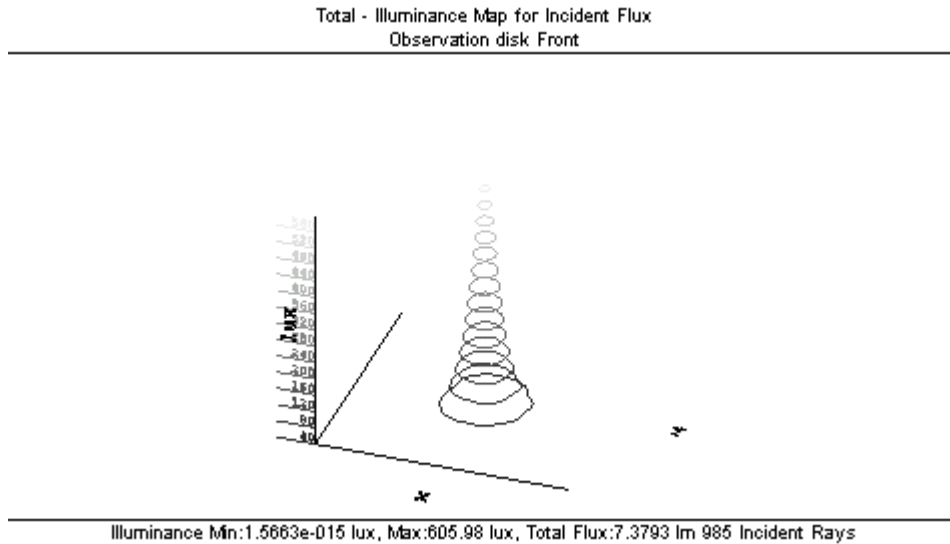

FIGURE 6.7 - Irradiance Map contours on Relief Plot for Elliptical Reflector demo.

Contour Levels

This controls how contours are displayed for Contour plots.

Auto levels

The Auto levels check box controls the contour levels in the contour plot.

If the Auto levels check box is checked, TracePro divides the display of intensity values evenly into the number of levels defined in the Number entry in the Levels part of the dialog box. Select the Apply button to update the levels with the new values from the dialog box. The legend is updated as well.

If Auto levels is not checked, TracePro uses the levels defined in the list box on the right hand side of the Levels section of the dialog box. You can customize the levels by moving numbers in and out of the box. Move numbers from the Selection box into the list by pressing the > button, and out (to remove them from the list) by pressing the < key.

You can use Auto levels for a desired number of contours and TracePro will equally space the number over the flux or candela range plotted.

Selection

When the Auto levels box is unchecked, TracePro uses the levels defined in the list box on the right hand side of the Levels section of the dialog box. You can customize the levels by moving numbers in and out of the box. Move numbers from the Selection box into the list by entering a value and pressing the --> button, and out (to remove them from the list) by selecting the value from the list and pressing the <-- key.

You can use Auto levels for a desired number of contours and TracePro will equally space the number of values over range plotted. Values can then be added or removed from this list.

Number

If the Contour Plot box is checked, this controls the number of contour levels that are displayed in the contour plot.

Use percent of Max.

This option lets you enter a percent (from 0.0 – 1.0) of the maximum plot value. TracePro calculates and sets levels for each value entered.

True color options

When *Quantities to plot* is set to *True color*, the *Contour Levels* box changes to *True Color Options*. This allows you to set the Brightness and Contrast on a scale of 0 to 1 and Gamma on a scale of 0 to 3 as shown in Figure 6.8.

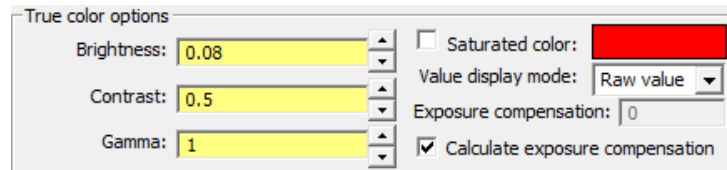

FIGURE 6.8 - True color options settings appear in place of Contour Levels when Quantities to plot is set to True color.

Saturated Color allows you to turn the Saturated Color on or off. The RGB values can range from 0-255. Saturated Color shows any pixels where any of the RGB values are 255. You can change the color for saturated pixels by clicking on the color bar.

Value mode has two options, Raw value and Integer. This setting controls the values displayed in the Status Bar when you move the mouse pointer over the map or rendering. The Raw value displays the floating-point RGB values in the Status Bar as calculated by TracePro to create the True Color image. When Integer is selected, the actual integer values used in the image (0-255 RGB) are displayed.

If Normalize to: is set to *Exposure value* and the *Calculate exposure compensation* box is checked, the *Exposure compensation* value for saturated white will be calculated automatically. If the *Calculate exposure compensation* box is not checked, an *Exposure compensation* value can be manually entered.

Automatically Calculate Normal and Up Vectors

The Normal Vector and Up Vector specify the orientation of the irradiance map. When you open an irradiance map window, TracePro uses those vectors to orient the map. Depending on the surface you have chosen, those vectors might not be in a sensible direction. You can re-enter the vectors, or you can check the *Automatically Calculate Normal and Up Vectors* box. If you check this box and press Apply, TracePro attempts to choose a sensible projection plane. If the surface is oddly shaped and/or does not project onto a plane sensibly, you might have to edit the Normal and Up vectors yourself. See "Normal and Up Vectors" on page 5.14.

Normal Vector

The Normal Vector is a vector in 3D space that is used to orient the projection plane for the irradiance map. The plane is defined to be perpendicular to the Normal Vector, and the irradiance incident on the selected surface is projected onto this plane. When the map is displayed, the normal vector is pointing away from you.

Up Vector

The Up Vector is a vector in 3D space that is used to orient the projection plane for the irradiance map. The plane is defined so that the Up Vector is parallel to the vertical side of the plane. The irradiance incident on the selected surface is projected onto this plane. When the map is displayed, the up vector will point toward the top of the screen.

Set Defaults

The options are saved when the Model is saved to disk in an OML file. After the data is changed, pressing the Set Defaults button will store the data into the TracePro defaults file to be used the next time TracePro is opened. See “User Defaults” on page 1.11.

Access to Irradiance Data

The results of an irradiance calculation can be exported from TracePro to another software package such as a spreadsheet or word processor. Make the irradiance map window the active window and select **Edi t |Copy** in TracePro. Go to the other software program (for example, Microsoft Excel) and select **Edi t |Paste**. The tabular data is transferred to the other program by the Windows clipboard. The data is tab-delimited to assist the transfer to a spreadsheet program. The Plot can also be copied as a bitmap via the **Edi t |Copy Bi tmap** menu.

You can save the underlying data in a text file. First, select the desired window to make it the active window. Second, select **FI l e |Save As** from the TracePro menu. The Save As dialog box displays to let you save the file with the default extension **.txt**. The file is saved in tab-delimited format, suitable for importing into a spreadsheet program. The plot can also be saved as a Windows bitmap file by selecting the **bmp** type from the Save as type list in the File Save As dialog box.

Ensquared Flux

TracePro includes the capability to select a rectangular area of the Irradiance Map and view the ensquared flux and to display the rays contained in the selected region. Display Selected Rays must be selected before selecting a region. To

select a region in the map, Hold down the SHIFT key, then left-click and drag on the Irradiance Map to select the “ensquared” area.

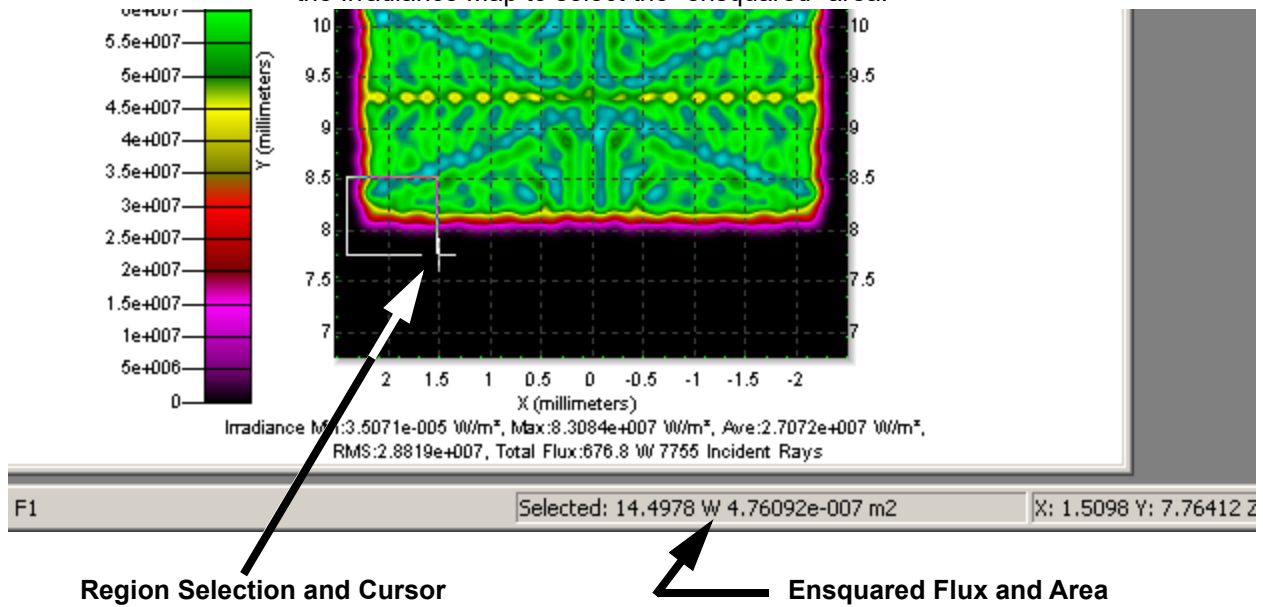

FIGURE 6.9 - Irradiance Region and Ensquared Flux

The flux and area are displayed in the status bar of the main TracePro window.

Display Selected Rays

To activate the “ensquared flux and rays” feature, select the **Analysis** Menu and check **Display Selected Rays**. When you view both the Irradiance Map and the Model Window you will see the rays contained in the selected region. The ray display updates after the selection is made.

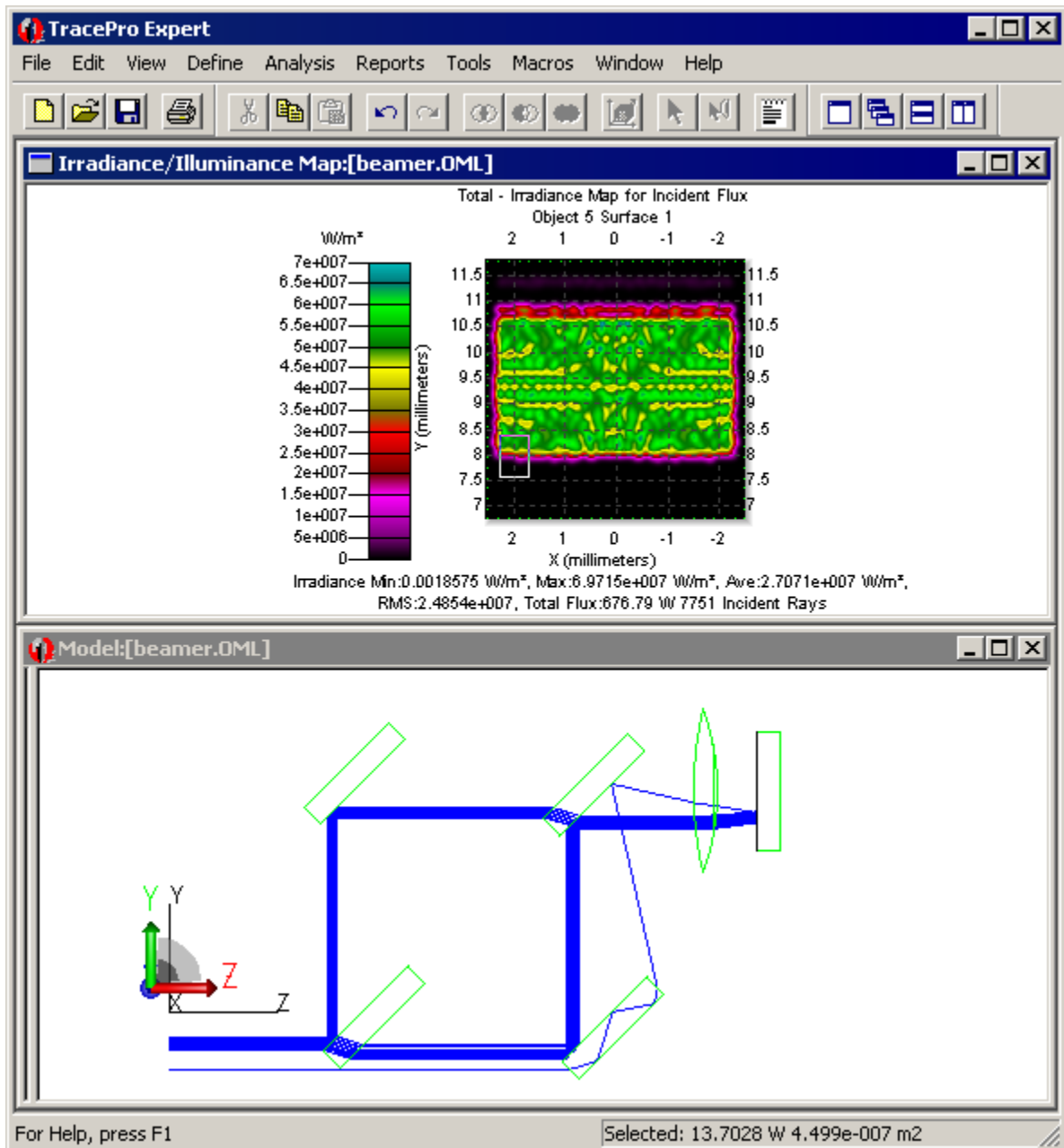

FIGURE 6.10 - Rays displayed for a selected Irradiance Map region.

Select Rays Dialog

You can also enter the selected region manually through the Select Rays Dialog. Open the dialog by selecting **Analysis | Select Rays...** Enter the new region corners and press the Set button to update the selection and show the new flux and area.

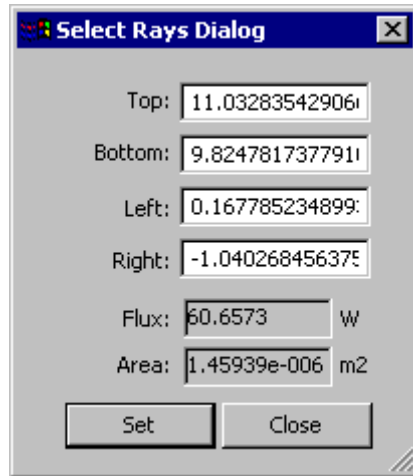

FIGURE 6.11 - Select Rays Dialog.

Luminance/Radiance Maps

After a Luminance map is traced as described in “Luminance/Radiance Ray Tracing” on page 5.38, the map is displayed from the Luminance Dialog. Display settings can be changed by right-clicking on the plot or by selecting **Analysis | Luminance/Radiance Map Options** from the TracePro main menu, then selecting the name of the map in the dialog box. The Options dialog is shown in Figure 6.12.

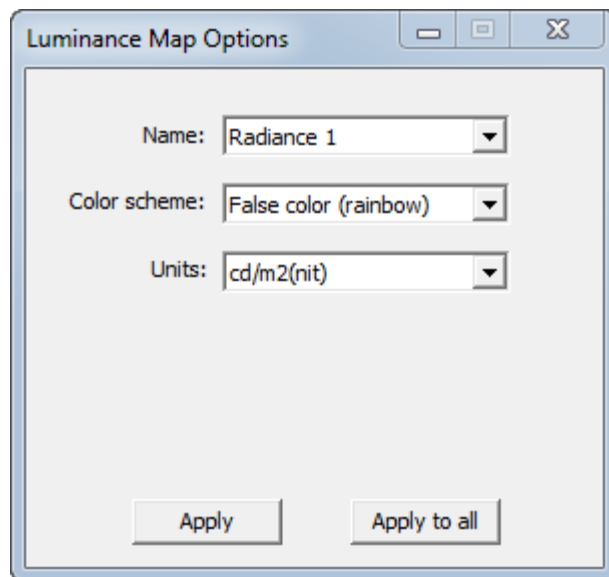

FIGURE 6.12 - Luminance Map Options dialog.

Color scheme

Selecting the True Color color scheme results in a true color or photorealistic rendering based on the wavelengths traced in the model. The more wavelengths

traced, the more accurate the rendering will be. If you trace just one wavelength, the rendering will appear illuminated in the color corresponding to that wavelength. No luminance/radiance units are displayed for a True Color map.

For any other Color Scheme selection, the colors in the map are as specified in the Color Scheme, with colors corresponding to luminance or radiance values.

Units

When you move the mouse over the map, the luminance/radiance value at the position of the mouse cursor is shown in the status bar.

- When Photometric Units are selected in the Raytrace Options dialog box, the Units selections available in the Luminance Map Options dialog box are cd/m²(nit), footlambert, or millilambert.
- When Radiometric Units are selected, the only units available for the Radiance Map Options are W/m².

An example plot is displayed in Figure 6.14. This example is further expanded upon, especially the usefulness of Auto importance sampling, in “Example Using Luminance/Radiance Maps” on page 9.65

True color options

When the *Color scheme* is set to *True color*, the *True color options* appear below the other settings, as shown in Figure 6.13. Here you can control the Brightness, Contrast, and Gamma using values from 0 to 1 for Brightness and Contrast and from 0-3 for Gamma.

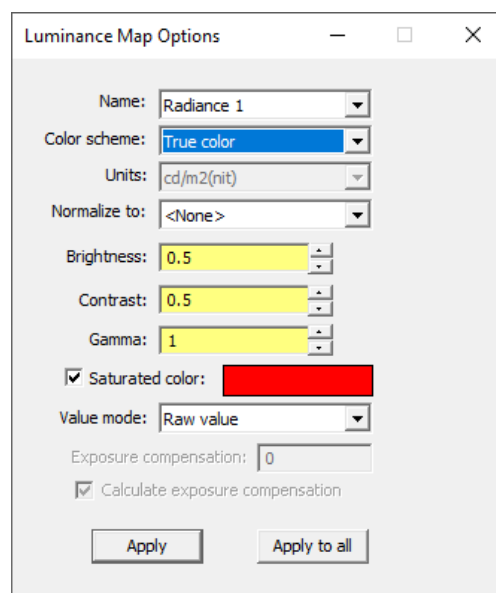

FIGURE 6.13 - Luminance Map Options dialog with *Color scheme* set to *True color*.

Normalize to: has 3 options: *None*, *Highest Color*, and *Exposure Level*. Selecting *Highest Color* will normalize the displayed color value in the plot. Selecting *Exposure Level* will normalize the plot to display a saturated white color, even is

the plot is monochromatic. For example, with green light the saturated values would be (0,255,0).

Saturated Color allows you to turn the Saturated Color on or off. The RGB values can range from 0-255. Saturated Color shows any pixels where any of the RGB values are 255. You can change the color for saturated pixels by clicking on the color bar.

Value mode has two options, Raw value and Integer. This setting controls the values displayed in the Status Bar when you move the mouse pointer over the map or rendering. The Raw value displays the floating-point RGB values in the Status Bar as calculated by TracePro to create the True Color image. When Integer is selected, the actual integer values used in the image (0-255 RGB) are displayed.

If Normalize to: is set to *Exposure value* and the *Calculate exposure compensation* box is checked, the *Exposure compensation* value for saturated white will be calculated automatically. If the *Calculate exposure compensation* box is not checked, an *Exposure compensation* value can be manually entered.

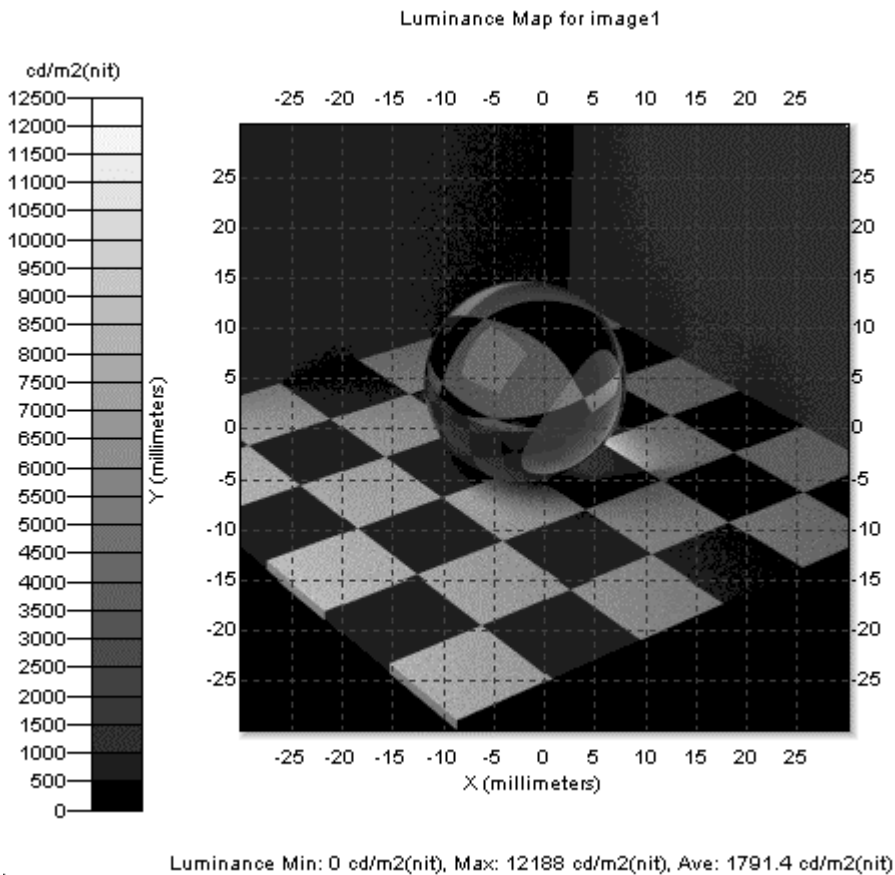

FIGURE 6.14 - Luminance plot in Grayscale.

3D Irradiance/Illuminance

3D Irradiance/Illuminance maps the incident or absorbed irradiance/illuminance on to the selected surfaces and/or objects. The color legend shows the irradiance over the surface. Each object and surface selected will be displayed.

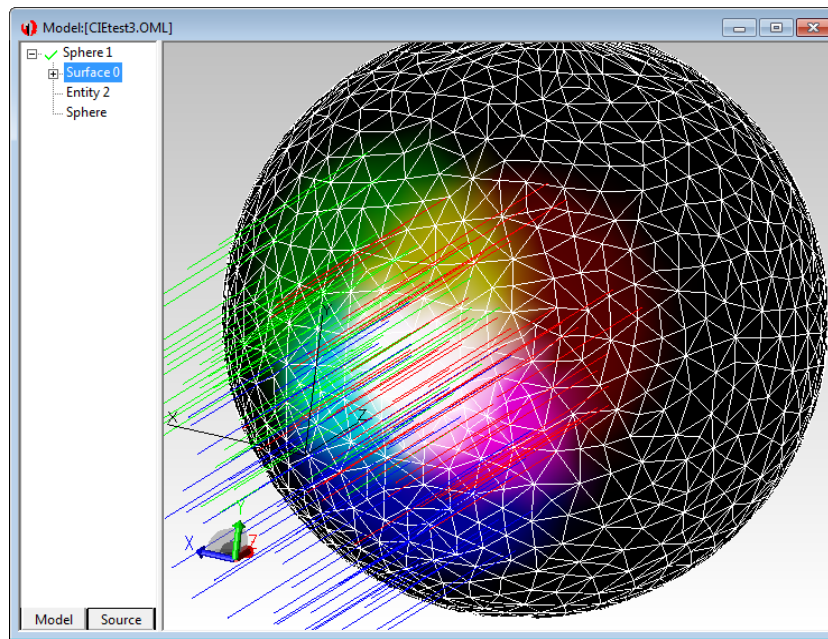

FIGURE 6.15 - 3D Irradiance/Illuminance displayed in Model Window on the surface of a sphere, with True Color option and edges of triangular pixels drawn.

3D Irradiance/Illuminance Options

The 3D Irradiance/Illuminance Options dialog box is accessed from the Analysis menu or by right-clicking on the Model Window when 3D Irradiance/Illuminance is turned on. The Options dialog provides the following parameters to control the irradiance/illuminance display.

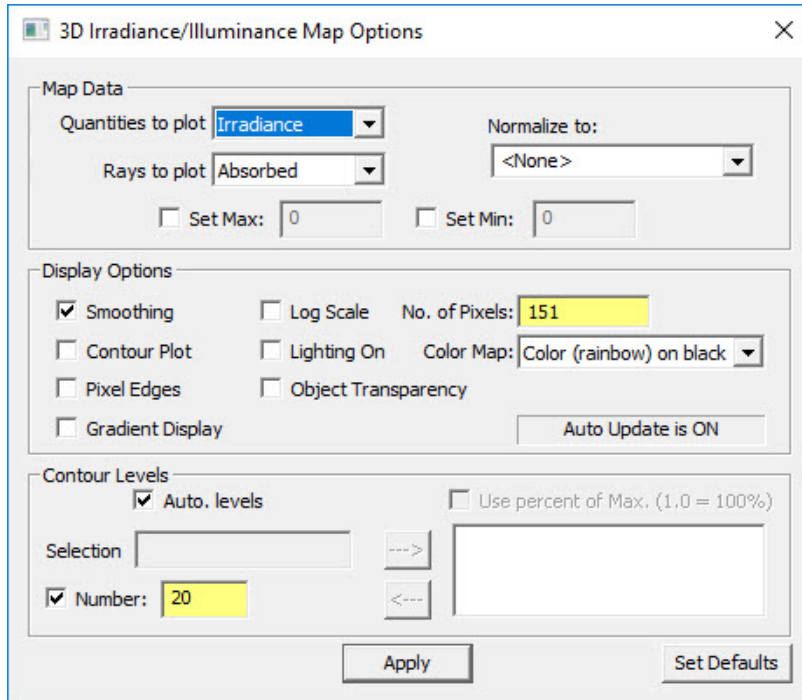

FIGURE 6.16 - 3D Irradiance/Illuminance Options dialog box.

Map Data

The Map Data defines what quantities are displayed in the plot.

Quantities to Plot

Selects the map type to display. You can choose from:

- Irradiance/Illuminance, a plot of flux per unit area of radiation incident on or absorbed by a surface,
- CIE (x, y), a plot of color in CIE xy coordinates,
- CIE (u',v'), a plot of color in CIE u'v' coordinates,
- True Color

When you display either a CIE xy or u'v' plot, a plot of the color of the light incident on the surface is displayed, at full brightness.

Rays to Plot

You can display a map of absorbed, incident, or exiting rays. Incident irradiance maps can be misleading when the selected surface is hit several times by the same ray. For example, a surface between two infinite parallel mirrors would have the same ray intersect the surface until the ray fell below the flux threshold or intercept threshold generating an incident flux many times greater than the starting flux of the ray. Exiting-ray irradiance maps can also be misleading for the same reason. In addition, take care that you do not interpret an exiting-ray irradiance

map as the appearance of the surface. To display the appearance of surfaces, use the Luminance Map.

Normalize to

Normalize the map data according to the selection. The choices are *None*, *Average emitted irradiance*, *Peak irradiance*. The default selection is for no normalization, i.e. actual irradiance (W/m^2) or illuminance (lux) values.

If Quantities to Plot is set to True Color, the *Normalize to:* options change to *None*, *Highest Color*, and *Exposure Level*. Selecting *Highest Color* will normalize the displayed color value in the plot. Selecting *Exposure Level* will normalize the plot to display a saturated white color, even if the plot is monochromatic. For example, with green light the saturated values would be (0,255,0).

Set Max/Min

The Max/Min values provide thresholds for the plot scale. If a Max value is set it will be used for the maximum value used in the Irradiance/Illuminance plot. Any values which exceed the Max value will be displayed at the Max value. The Min value works in the same manner. If the Log Scale is set the Min value is disabled.

Display Options

The display options control the plot output.

Smoothing

If the smoothing box is checked, the irradiance distribution will be smoothed.

Contour Plot

Selecting Contour Plot creates a topographic map of the irradiance/illuminance. Smoothing is always turned on when you select Contour Plot. The number of contours and contour levels is described in the Contour Levels section below.

Pixel Edges

The edges of the triangular pixels will be displayed to help visualize the surface.

Gradient Display

Checking this box causes a continuous gradation of colors to be displayed instead of discrete contours.

Log Scale

Checking this box displays the irradiance on a logarithmic scale. This is especially useful when you need to see details in the very lowest irradiance values. This might be needed, for example, in a stray light analysis.

Lighting On

Turn on ambient lighting to help in visualizing the shape of the surface(s) on which the irradiance/illuminance is displayed.

No. of Pixels

The *No. of Pixels* value determines the resolution of the display on the irradiance map. The value is used to calculate the maximum edge length of the triangular

pixels. The maximum edge length is set to the diagonal of the largest box enclosing any selected surface, divided by the No. of Pixels. The shape of the boundary of the surface or the local curvature of the surface may require a smaller edge length, so some pixels may be smaller.

Color Map

Use this drop-down list to opt for either grayscale or one of several color-coded schemes. The choice of color affects both the display and the contour map display.

Contour Levels

This controls how contours are displayed for Contour plots.

Auto levels

The Auto levels check box controls the contour levels in the contour plot.

If the Auto levels check box is checked, TracePro divides the display of intensity values evenly into the number of levels defined in the Number entry in the Levels part of the dialog box. Select the Apply button to update the levels with the new values from the dialog box. The legend is updated as well.

If Auto levels is not checked, TracePro uses the levels defined in the list box on the right hand side of the Levels section of the dialog box. You can customize the levels by moving numbers in and out of the box. Move numbers from the Selection box into the list by pressing the --> button, and out (to remove them from the list) by pressing the <-- button.

You can use Auto levels for a desired number of contours and TracePro will equally space the number over the flux or candela range plotted.

Selection

When the Auto levels box is unchecked, TracePro uses the levels defined in the list box on the right hand side of the Levels section of the dialog box. You can customize the levels by moving numbers in and out of the box. Move numbers from the Selection box into the list by entering a value and pressing the --> button, and out (to remove them from the list) by selecting the value from the list and pressing the <-- button.

You can use Auto levels for a desired number of contours and TracePro will equally space the number of values over range plotted. Values can then be added or removed from this list.

Number

If the Contour Plot box is checked, this controls the number of contour levels that are displayed in the contour plot.

Use percent of Max.

This option lets you enter a percent (from 0.0 – 1.0) of the maximum plot value. TracePro calculates and sets levels for each value entered.

True color options

When *Quantities to plot* is set to *True color*, the *Contour Levels* box changes to *True color options*. This allows you to set the Brightness and Contrast on a scale of 0 to 1 and Gamma on a scale of 0 to 3 as shown in Figure 6.17.

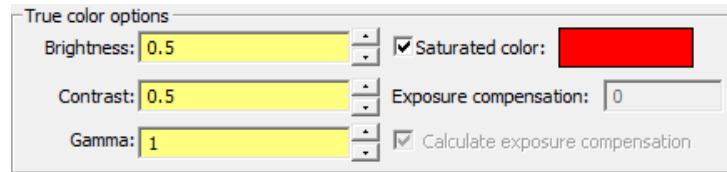

FIGURE 6.17 - *True color options* settings appear in place of *Contour Levels* when *Quantities to plot* is set to *True color*.

Saturated Color allows you to turn the Saturated Color on or off. The RGB values can range from 0-255. Saturated Color shows any pixels where any of the RGB values are 255. You can change the color for saturated pixels by clicking on the color bar.

Value mode has two options, Raw value and Integer. This setting controls the values displayed in the Status Bar when you move the mouse pointer over the map or rendering. The Raw value displays the floating-point RGB values in the Status Bar as calculated by TracePro to create the True Color image. When Integer is selected, the actual integer values used in the image (0-255 RGB) are displayed.

If *Normalize to:* is set to *Exposure value* and the *Calculate exposure compensation* box is checked, the *Exposure compensation* value for saturated white will be calculated automatically. If the *Calculate exposure compensation* box is not checked, an *Exposure compensation* value can be manually entered.

Apply

Updates the plot.

Set Defaults

The options are saved when the Model is saved to disk in an OML file. After the data is changed, pressing the Set Defaults button will store the data into the TracePro defaults file to be used the next time TracePro is opened. See “User Defaults” on page 1.11.

Candela Plots

Candela plots can be viewed by first selecting **Analysis|Candela Plots** and next selecting **Polar Iso-Candela**, **Rectangular Iso-Candela**, **Polar Candela Distribution** or **Rectangular Candela Distribution**.

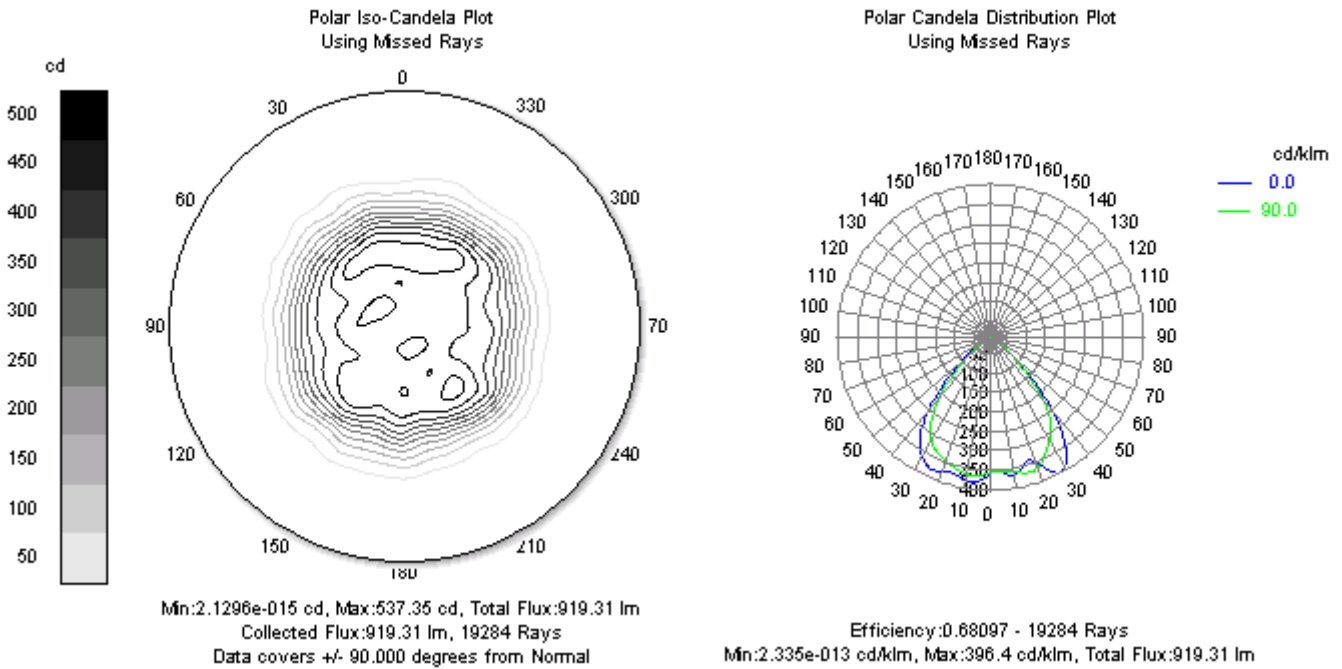

FIGURE 6.18 - Polar Iso Candela Contours (left) Candela Distribution in Luminaire Format (right)

A candela plot is a plot of luminous intensity, or flux per solid angle. In photometric units, a luminous intensity plot is in units of candelas (lumens per steradian). In radiometric units, an intensity plot is in units of watts per steradian. Candela plots are commonly used in the design of illumination systems, especially those used in the far field.

Candela data can be collected from ray sets of *Missed rays*, rays *Exiting* a surface or rays *Incident* on a surface. *Missed rays* are a collection of all rays that “leave” the model and “go off to infinity.” *Exiting rays* are the collection of ray segments following the intersection point of a ray at a surface. Due to ray splitting, several ray segments may contribute to the candela data for each incident ray. *Incident rays* are the collection of ray segments which intersect the selected surface. No surface selection is required for Missed rays but one is necessary for Exiting and Incident rays.

The candela plots represent flux versus angle and can be smoothed using the *Candela Options* dialog box. The iso-candela plots can be presented as false color maps or contour plots. The distribution plots are graphs of cross-sectional curves through the candela distribution.

The orientation of the candela plots is determined by the Normal Vector and the Up Vector, as specified in the **Analysis|Candela Options** dialog box. The normal vector specifies the axis of the candela plot and the up vector specifies “which way is up.”

Candela Options

Candela map options are controlled through the *Candela Options* dialog box, accessed by selecting **Analysis | Candela Options** or by right-clicking on the candela plot. The dialog box is divided into tabbed tabs:

- Orientation and Rays
- Polar Iso-Candela
- Rectangular Iso-Candela
- Candela Distributions

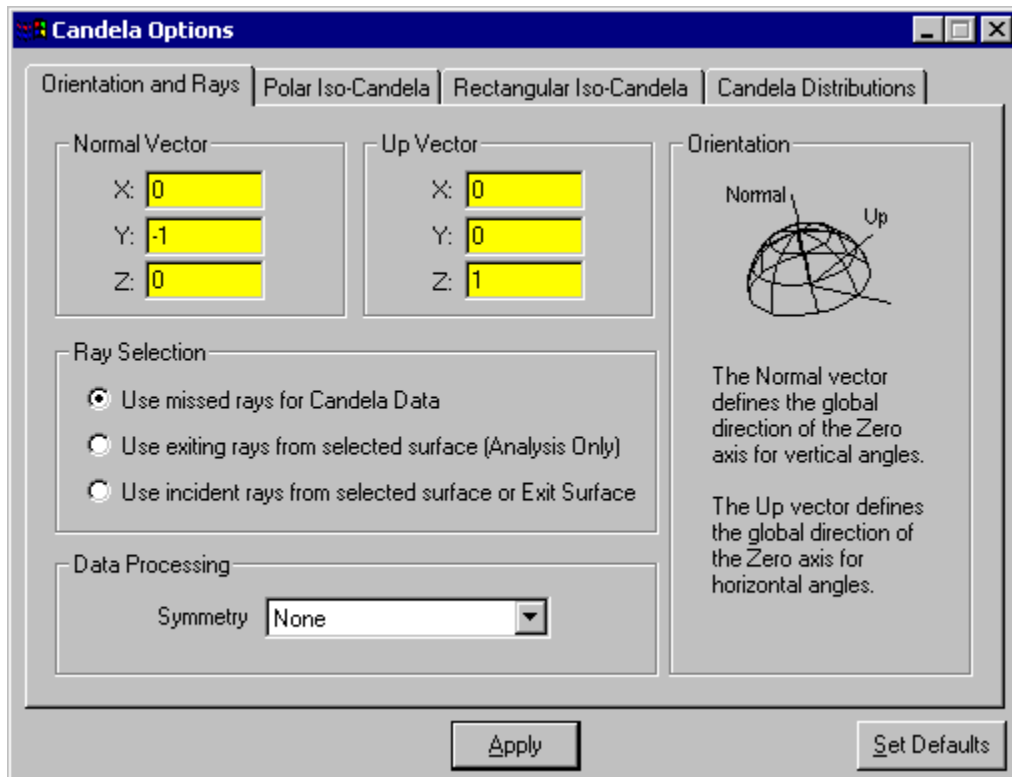

FIGURE 6.19 - Candela Options dialog with the Orientation and Rays tab displayed.

The *Orientation and Rays* options section is used for all Candela plots. Each option and its function are described in the sections that follow.

Set Defaults

The options are saved when the Model is saved to disk in an OML file. After the data is changed, pressing the Set Defaults button will store the data into the TracePro defaults file to be used the next time TracePro is opened. See “User Defaults” on page 1.11.

Orientation and Rays

Normal Vector

The Normal Vector is a vector in 3D space that is used to orient the polar axis in candela plots. The center of the candela/intensity plots is based on that direction. On the map, the normal vector is pointing away from you and toward the candela plot. It as though are looking along the vector that is pointing to the center of the distribution, and the standard is to look along the direction of light propagation. For example, if you are designing an illuminator that projects light to the right, i.e., along the +z axis, then you probably want the Normal Vector to be $X=0, Y=0, Z=1$.

Up Vector

The Up Vector is a vector in 3D space that is used to orient the direction that is “up” in the candela plots. The orientation is defined so that the Up Vector points up, i.e. toward the top of the screen in the candela plots. For example, if you are designing an illuminator that projects light to the right as in the example described in the previous paragraph, i.e., along the +z axis, then you probably want the Normal Vector to be $X=0, Y=0, Z=1$. Since the y axis normally points up in TracePro, you probably want the Up Vector to be $X=0, Y=1, Z=0$ for this example. If you want to see what that distribution would look like if you were standing on your head, set the Up Vector to $X=0, Y=-1, Z=0$.

Candela Plot Orientation Example

For example, if you are designing an illuminator that projects light to the right, i.e., along the +z axis, then you probably want the Normal Vector to be $X=0, Y=0, Z=1$. Since the y axis normally points up in TracePro, you probably want the Up Vector to be $X=0, Y=1, Z=0$ for this example. If you are designing a light fixture that points down, then you want the normal vector to be $X=0, Y=-1, Z=0$ and the Up Vector to be either $X=1, Y=0, Z=0$ or $X=0, Y=0, Z=1$. Figure 6.20 shows two hemispheres that correspond to the Normal and Up vectors defined in this example. The picture on the left has a Normal of $(0,0,1)$ and the picture on the right has a normal of $(0,-1,0)$. The Normal and Up vectors reference the global origin displayed in Figure 6.20.

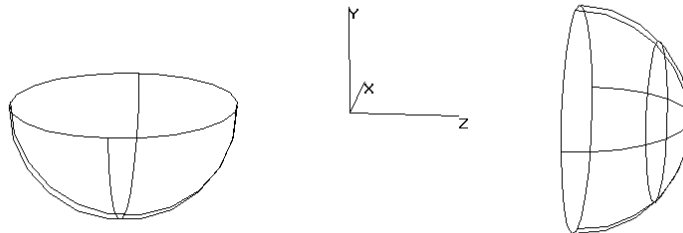

FIGURE 6.20 - Candela hemispheres for left) Normal vector $(0,-1,0)$, Up vector $(0,0,1)$ and right) Normal vector $(0,0,1)$, Up vector $(0,1,0)$

Ray Selection

Ray Selection lets you choose which rays to use as Candela Data. You can select either:

- Missed rays - all rays that continue beyond all objects in the Model.
- Exiting rays from selected surface (Analysis Mode only) - rays that leave the selected surface (Not available for a Simulation Mode ray trace)
- Incident rays from selected surface or Exit Surface - rays that intercept the selected surface

Data Processing | Symmetry

Using this option, you can take advantage of known symmetry on a Candela plot. A smoother distribution can be obtained from fewer rays. The five symmetry selections are:

- None - This is the default where no symmetry is applied.
- Left / Right - Symmetry is applied between the left and right halves of the plot.
- Up / Down - Symmetry is applied between the upper and lower halves of the plot.
- Quadrant - This is the combination of Left / Right and Up / Down symmetry.
- Rotational - Symmetry is applied about an axis perpendicular to the center of the plot.

The symmetry selection should be used with caution. TracePro will force symmetry onto the Candela plot even if your model does not possess symmetry. The user, through this option, conveys to TracePro that the data being plotted actually has the selected symmetry.

Polar Iso-Candela

A Polar Iso-Candela Plot shows spherical polar angle on the polar axis. It shows a spherical azimuth angle in the azimuth direction. This plot maps a hemisphere onto a plane. The distribution plots display curves in either rectangular or polar format.

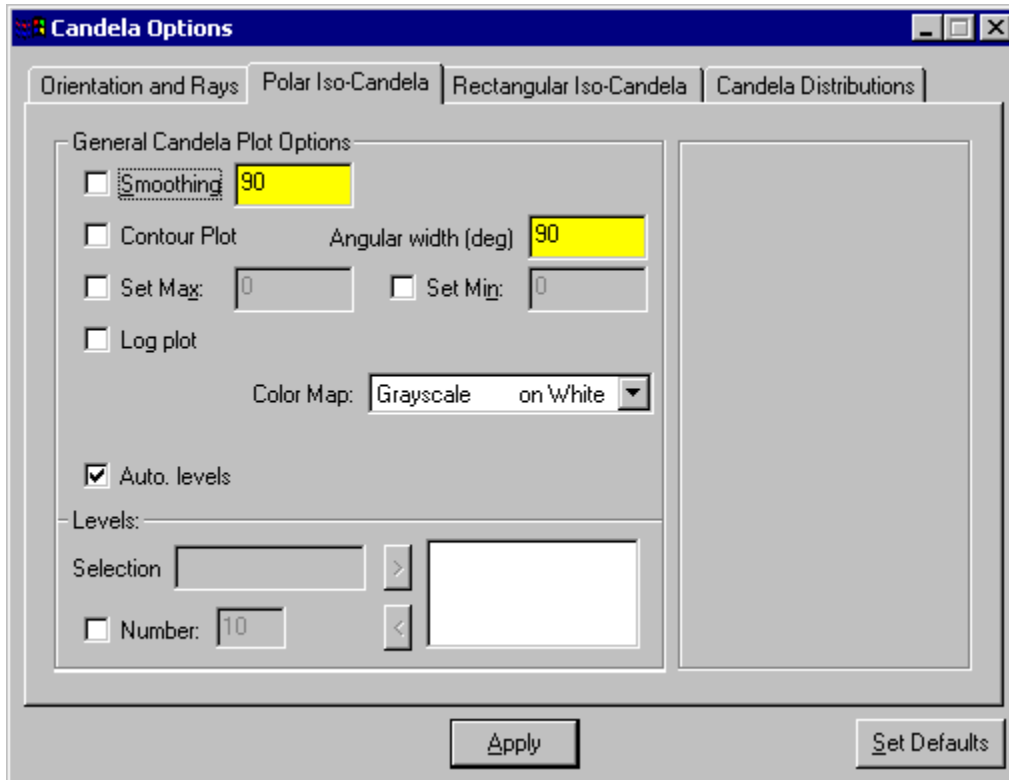

FIGURE 6.21 - Candela Options dialog with the Polar Iso-Candela tab displayed.

Smoothing

If the smoothing box is checked, the intensity distribution will be smoothed using a Gaussian smoothing kernel of the form

$$K(\theta_x, \theta_y) = \frac{1}{2\pi\sigma^2} e^{-(\theta_x^2 + \theta_y^2)/(2\sigma^2)}, \tag{6.3}$$

where σ is the waist radius of the Gaussian. The number to the right of the Smoothing check box is used as the waist radius. For example, a value of 20 means that the waist radius of the kernel is 1/20 of the width of the map.

The smoothing is done by convolving this kernel with the candela or intensity distribution,

$$E_{\text{smooth}}(\theta_x, \theta_y) = \iint E(\theta_x', \theta_y') K(\theta_x - \theta_x', \theta_y - \theta_y') d\theta_x' d\theta_y', \tag{6.4}$$

The convolution is done by Fourier transforming, applying a filter, and inverse Fourier transforming.

Contour Plot

If the Contour Plot box is checked, the Polar Iso-Candela data is displayed as a contour plot. The number of levels displayed is determined by the Number entry in the Levels part of the Polar Plots section of the dialog box.

Angular width

The Polar Iso-Candela plot is displayed over a subset of a hemisphere of the entered angular width. The angle is entered in degrees.

Set Max/Min

Sets the Max or Min value to plot. If the item is enabled, the value entered in the edit box will be used when the plot is updated.

Log Plot

Checking this box displays the data on a logarithmic scale. This is especially useful when you need to see details in the very lowest data values. This might be needed, for example, in a stray light analysis.

Color Map

Use this drop-down list to choose either grayscale or one of several color-coded schemes. The choice of color affects both the display and the contour map display on the Iso-Candela Plot as well as the distribution plots.

Auto levels

The Auto levels check box controls the contour levels in the Polar Iso-Candela plot. If the Auto levels box is checked, TracePro divides the display of intensity values evenly into the number of levels defined in the Number entry in the Levels part of the dialog box. When you click the Apply button, the plot is updated with the new levels.

Selection

If Auto levels is not checked, TracePro uses the levels defined in the list box on the right hand side of the Levels section of the dialog box. You can customize the levels by moving numbers in and out of the box. Move numbers from the Selection box into the list by clicking the --> button, and out (to remove them from the list) by clicking the <-- button.

You can use Auto levels for a desired number of contours and TracePro will equally space the number over the flux or candela range plotted.

Number

This entry controls the number of Auto levels displayed either in the color-coded intensity or contour Polar Iso-Candela plot.

Text File Format

A text file saved from a polar iso-candela plot starts with header information, e.g.

TracePro Release: *[major release no] [minor release no] [dot release no]*

Polar Iso-Candela Data for *[path and file name of TracePro file]*

Data covers +/- 90.000 degrees from Normal

Data for Missed Rays

Data generated at 09:55:10 June 15, 2012

This is followed by the raw data for the candela map. The data items are candela values or intensity values (W/sr) evaluated in a 128x128 grid. The actual data lies in a circular region superimposed on the grid. The pole on the grid is halfway between the 64th and 65th row and the 64th and 65th column. Therefore the data for a given entry in the table corresponds to polar (θ) and azimuth (ϕ) angles as follows:

$$\theta_{ij} = (\theta_{\max}/64) [(i-64.5)^2 + (64.5-j)^2]^{1/2}$$

$$\phi_{ij} = \text{atan2}(64.5-i, 64.5-j)$$

where

θ_{\max} is the angular width of the plot as entered in the Candela Options dialog box, Polar Iso-Candela tab (and in the file header),

i=column number (1 – 128, left to right)

j=row number (1 – 128, top to bottom)

and atan2 is the arctangent function taking arguments as

atan2(y, x)

Rectangular Iso-Candela

A Rectangular Plot shows the intensity or candela distribution as a function of vertical and horizontal angles. This is in contrast to the Polar Plot, in which the pole of the polar coordinates is in the center of the plot. For the Rectangular Plot, the equator is in the center of the plot, so that the angles are vertical and horizontal angles. A square angular region is displayed on the plot. The size of the region can be controlled in this area of the dialog box.

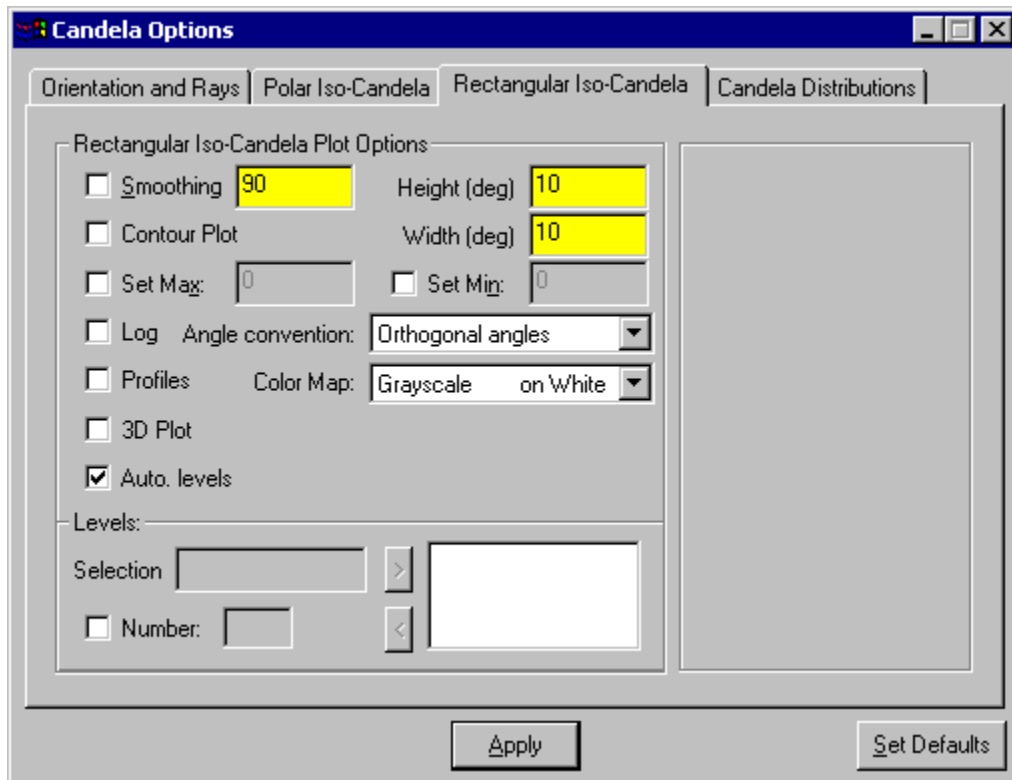

FIGURE 6.22 - Candela Options dialog with the Rectangular Iso-Candela tab displayed.

Height and Width

These entries control the size of the angular region that is plotted. The dimensions are in degrees. The center of the plot is along the direction of the Normal Vector. The top of the plot is along the direction of the Up Vector.

Angle Convention

The Angle convention defines the method used to display the rectangular plot. Selecting Orthogonal angles displays the angular data projected onto the x-z and y-z orthogonal planes. Type A and Type B goniometers use the angle conventions outlined in the Lighting Handbook, published by the Illuminating Engineering Society of North America (IESNA).

Profiles

Display an XY plot in the same window with data slices based on the mouse cursor position.

3D Plot

This option produces a 3D relief plot using OpenGL.

Candela Distributions

The Candela Distribution plots are defined as slices of the sphere containing the emitting source. The number of slices and resolution can be defined by the user.

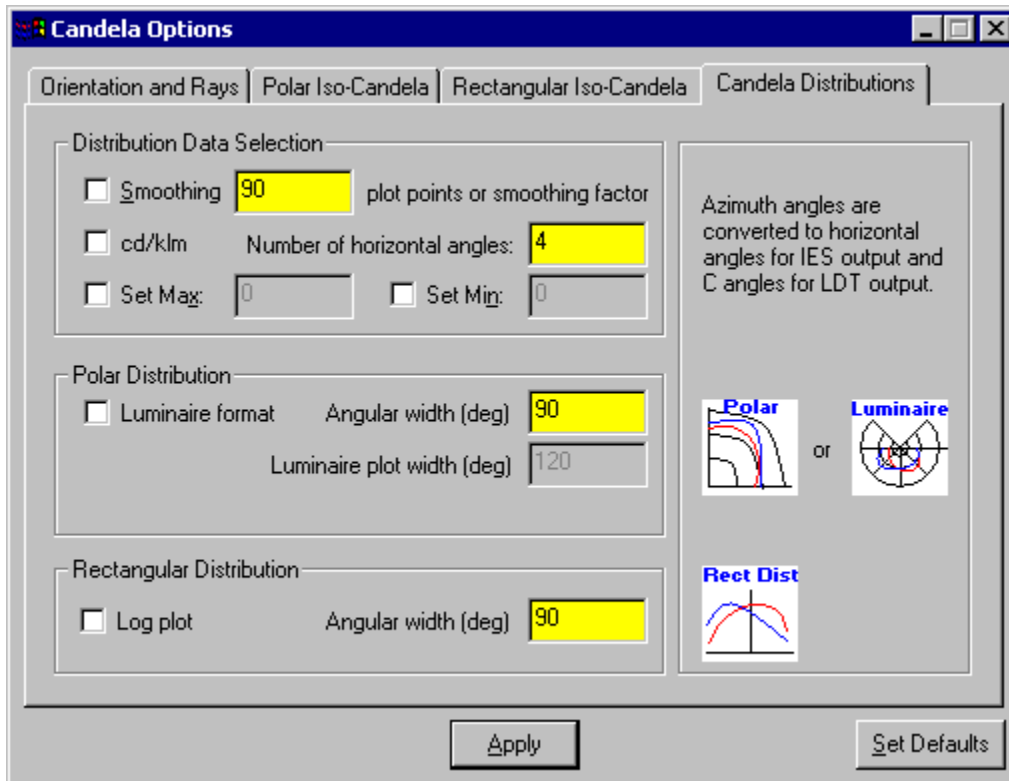

FIGURE 6.23 - Candela Options dialog with the Candela Distributions tab displayed.

Smoothing

This option determines whether smoothing is performed on the data slices. If enabled, the number in the smoothing box is used as a smoothing factor. If smoothing is off, the number sets the number of points about the slices to display in the plot.

cd/Klm

Scales output to cd per 1000 lumens. This is a common scale factor for lighting output.

Number of horizontal angles

Sets the number of horizontal angles to plot. The value set here corresponds to the horizontal angles in **IES** (IESNA) format and to C angles in **ldt** (eulumdat) format files. See "IESNA and Eulumdat formats" on page 6.35.

Luminaire format

When checked, the format of the Polar Candela Distribution plot changes to conform to the standard Luminaire Design format, with the Normal Vector pointing down.

Angular width

Sets the angular width of the luminaire display in degrees. The width for polar and rectangular distributions can be set individually.

Luminaire width

Sets the angular range of the display in degrees when the Luminaire format is selected.

Set Max/Min

Sets the Max or Min value to plot. If the item is enabled, the value entered in the edit box will be used when the plot is updated.

Log Plot

Checking this box displays the data on a logarithmic scale. This is especially useful when you need to see details in the very lowest data values. This might be needed, for example, in a stray light analysis.

IESNA and Eulumdat formats

Data can be saved to a text file in IESNA (**ies**) and Eulumdat (**ldt**) formats. When saving the data to a text file via **File | Save As** or right clicking in the display window and selecting **Save As...**, the file format is selected with the file extension drop down box. The IES format is specified in IESNA (Illuminating Engineering Society of North America) standard LM-63-02. Figure 6.24 summarizes the IESNA conventions for angles used in the IESNA format for Type C photometry.

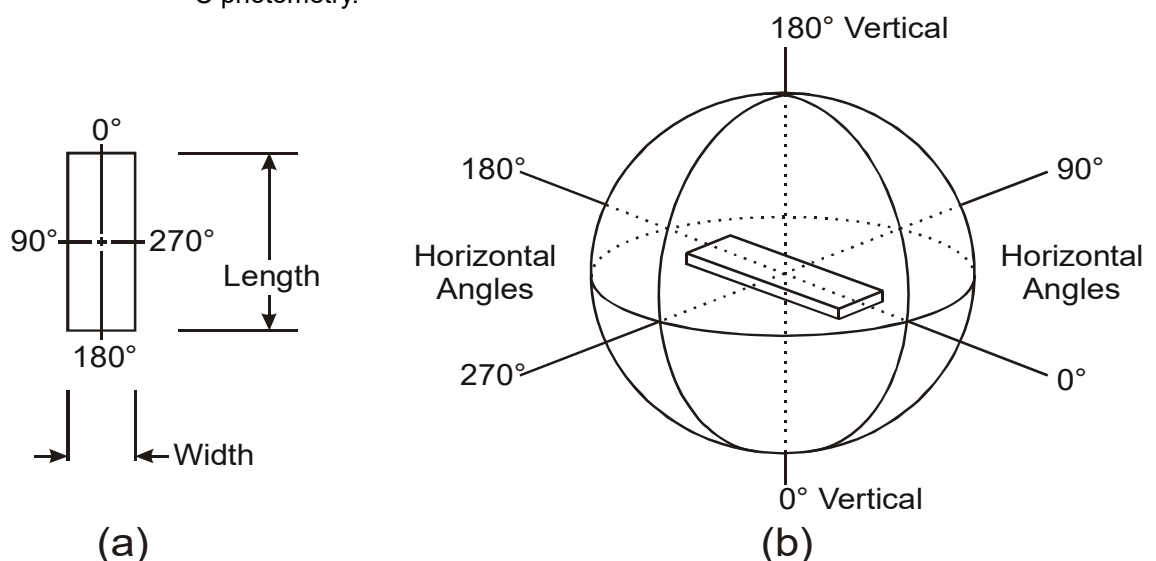

FIGURE 6.24 - Conventions for vertical and horizontal angles used in standard IESNA format for Type C photometry; (a) plan view of

luminaire showing length and width in relation to horizontal angles, and (b) schematic showing vertical and horizontal angles.¹

Figure 6.25 shows the dialog that appears when you select Save As. There are four options for the file types: text (*.txt), IESNA LM-63 (*.ies), Eulumdat (*.ldt), and bitmap (*.bmp). The text file option saves the data to a text file. The bitmap option saves a bitmap screen shot of the plot. The IESNA and Eulumdat options provide a number of options to save the data. The following paragraphs explain and show these options.

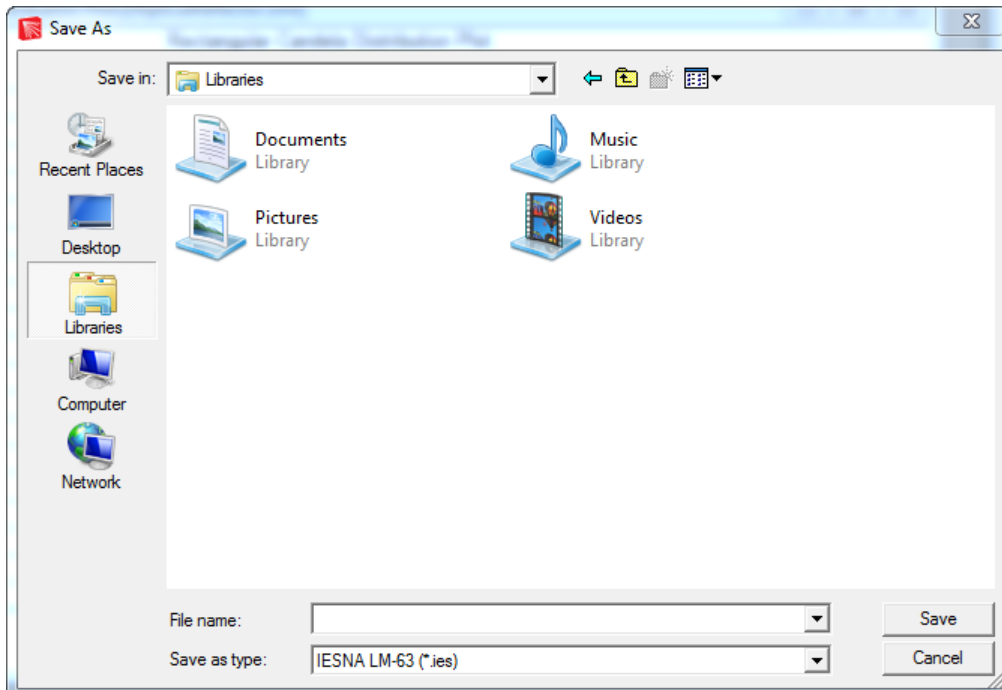

FIGURE 6.25 - Save As dialog for candela plots with IESNA type selected.

When the IESNA format is chosen for *Save as type* in the **F I l e | Save As** dialog, a dialog box opens allowing you to enter inputs appropriate to the IESNA standard, including the number of lamps, number of angles, and luminous dimensions (see Figure 6.26). This additional dialog is displayed upon selecting the *.ies option.

1. Reproduced from *IESNA LM-63-02 Standard File Format for Electronic transfer of Photometric Data*, p.4, © Illuminating Engineering Society of North America.

FIGURE 6.26 - The additional *IES File Auxiliary Data* dialog for the IESNA format allows you to enter a number of IESNA-specific parameters.

The various options are:

- **Test Lab:** for information only.
- **Manufacturer:** for information only.
- **# Lamps:** the number of lamps in the measurement. Use the *Get from raytrace sources* button to get the number of active sources in the model.
- **Absolute Photometry or Relative Photometry:** From IESNA LM-63-02: “Absolute photometry consists of the simultaneous comparison of a standard lamp and an unknown light source. Relative photometry consists of the evaluation of the photometric characteristic of a lamp by comparison with the assumed lumen or spectral output of a test lamp.”
- **Lumens per lamp:** Number of lumens per lamp in the model. The default value is the sum of the lumen output of all sources in the model divided by the number of sources. If you select *Absolute Photometry* (see above) the number is set to -1 and is not editable.
- **Photometric** (i.e., type of goniometer): The goniometer type for the data in the IES file. This entry is not editable and depends on the type of plot from which you selected *Save As* and the settings in the *Candela Options* as follows: **Polar Iso-candela Plot** - N/A; **Rectangular Iso-candela Plot** - Type A or Type B depending on the *Angle convention* setting in *Candela Options*; **Rectangular or Polar Distribution Plot** - Type C only.
- **Vertical angles:** the number of angles to save in the vertical direction.
- **Multiplier:** the multiplier that should be applied to the data.

- **Horizontal angles:** the number of angles along the horizontal direction (available for Type C Rectangular Iso-candela Plot only).
- **# decimals:** Number of decimal points of precision to use when writing candela values to the file.
- **Symmetry, Horizontal angles:** This setting is not editable and depends on the Symmetry setting in **Candela Options** as follows: **None** -> 0 - 360; **Left/Right** -> 0 - 180; **Up/Down** -> N/A; **Quadrant** -> 0 - 90; **Rotational** -> 0 - 0.
- **Vertical angle range:** range of vertical angles for output of candela values. The ranges available depend on the *Angle convention* setting in **Candela Options**.
- **Width:** the width of the luminous area of the source in the designated units.
- **Length:** the length of the of the luminous area of the source in the designated units.
- **Height:** the height of the luminous area of the source in the designated units.
- **Combo box:** units for the luminous dimensions of the source, in Feet or in Meters.

When the Eulumdat format is chosen in the **File|Save As** dialog, you are allowed to enter a number of inputs appropriate to the Eulumdat standard, including the number of lamps, symmetry and luminous dimensions (see Figure 6.27). This additional dialog is displayed upon selecting the *.ldt option.

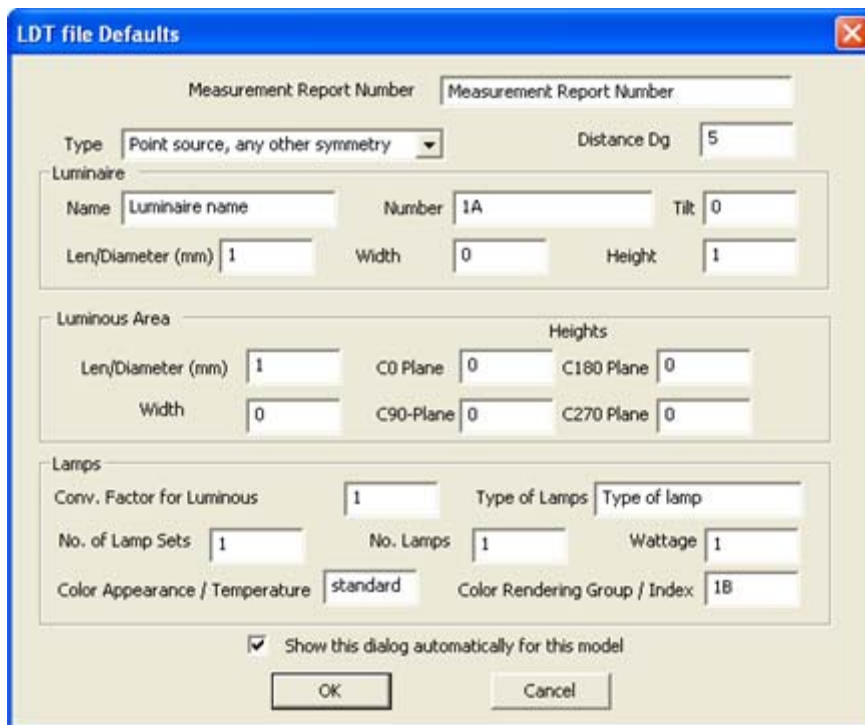

FIGURE 6.27 - The additional Save As dialog for the Eulumdat format allows you to enter a number of Eulumdat-specific parameters.

The various options are (the bolded items denote the default values):

- Measurement Report Number: the designator given to the report for this file save, **Measurement Report Number**,
- Type: the type of source and its symmetry, point source, vertical axis symmetry; linear luminaire; or **point source, any other symmetry** (note that only the linear luminaire option is subdivided into longitudinal and transverse directions),
- Distance Dg: the distance in degrees between luminous intensities in the C-plane, **5**,
- Luminaire Name: name of the luminaire, **Luminaire name**,
- Luminaire Number: the luminaire number for quality control, **1**,
- Luminaire Tilt: the tilt angle of the luminaire during testing, **0**,
- Luminaire Len/Diameter: the length or diameter of the luminaire in mm, **1**,
- Luminaire Width: the width of the luminaire in mm, with 0 for circular luminaires, **0**,
- Luminaire Height: the height of the luminaire in mm, **1**,
- Luminous Area Len/Diameter: the length or diameter of the luminous area in mm, **1**,
- Luminous Area Width: the width of the luminous area in mm, **0**,
- C0 Plane: the height of the luminous are C0-Plane in mm, **0**,
- C90 Plane: the height of the luminous are C90-Plane in mm, **0**,
- C180 Plane: the height of the luminous are C180-Plane in mm, **0**,
- C360 Plane: the height of the luminous are C360-Plane in mm, **0**,
- Conv. Factor for Luminous: the multiplier for the data to be saved, **1**,
- Type of Lamps: the type of lamp(s) in the file, **Type of lamp**,
- No. of Lamp Sets: the number of lamp sets used for the model, **1**,
- No. Lamps: the number of lamps that comprise a set, **1**,
- Wattage: the electrical wattage of the system including ballast, **1**,
- Color Appearance/Temperature: the color appearance or color temperature of the model, **standard**,
- Color Rendering Group/Index: the CRI or CR Group for the model, **1B**, and
- Checkbox: checking this box will open this dialog whenever the Eulumdat (*.ldt) file type is selected. If the box is unchecked, then this dialog will not automatically open, but it can be manually opened by clicking on the Modify File Defaults button as shown in Figure 6.25.

Access to Candela/Intensity Data

The results of an intensity calculation can be easily exported from TracePro to another software package such as a spreadsheet or word processor. Do this by making the appropriate candela plot window active and selecting **Edi t | Copy** or pressing Ctrl-C in TracePro. Switch to the other software program, such as Microsoft Excel, and select **Edi t | Paste** or press Ctrl-V. The tabular data is transferred to the other program via the Windows clipboard. The plot image can also be copied as a bitmap via the **Edi t | Copy Bi tmap** menu item.

You can also save the underlying data in a text file. First select the desired window to make it the active window, then select **Fi l e | Save As** from the TracePro menu.

The Save As dialog box displays to save the file with the default extension **txt**. The file is saved in tab-delimited format, suitable for importing into a spreadsheet program. Candela plots can be saved in IESNA LM-63-95 standard format (***.ies**), the Eulumdat (***.ldt**) or Windows Bitmap (***.bmp**) formats by selecting the file type in the Save As dialog box.

Enclosed Flux

TracePro includes the capability to select regions within the Polar and Rectangular Iso-Candela plots to view the Enclosed Flux and optionally to display the rays contained in the selected region.

Polar Iso-Candela

The polar plot requires use of the Select Rays Dialog. See “Select Rays Dialog” on page 6.42. By setting the values of the Polar and Azimuth angles circular and annular regions can be defined as well as circular and annular sections.

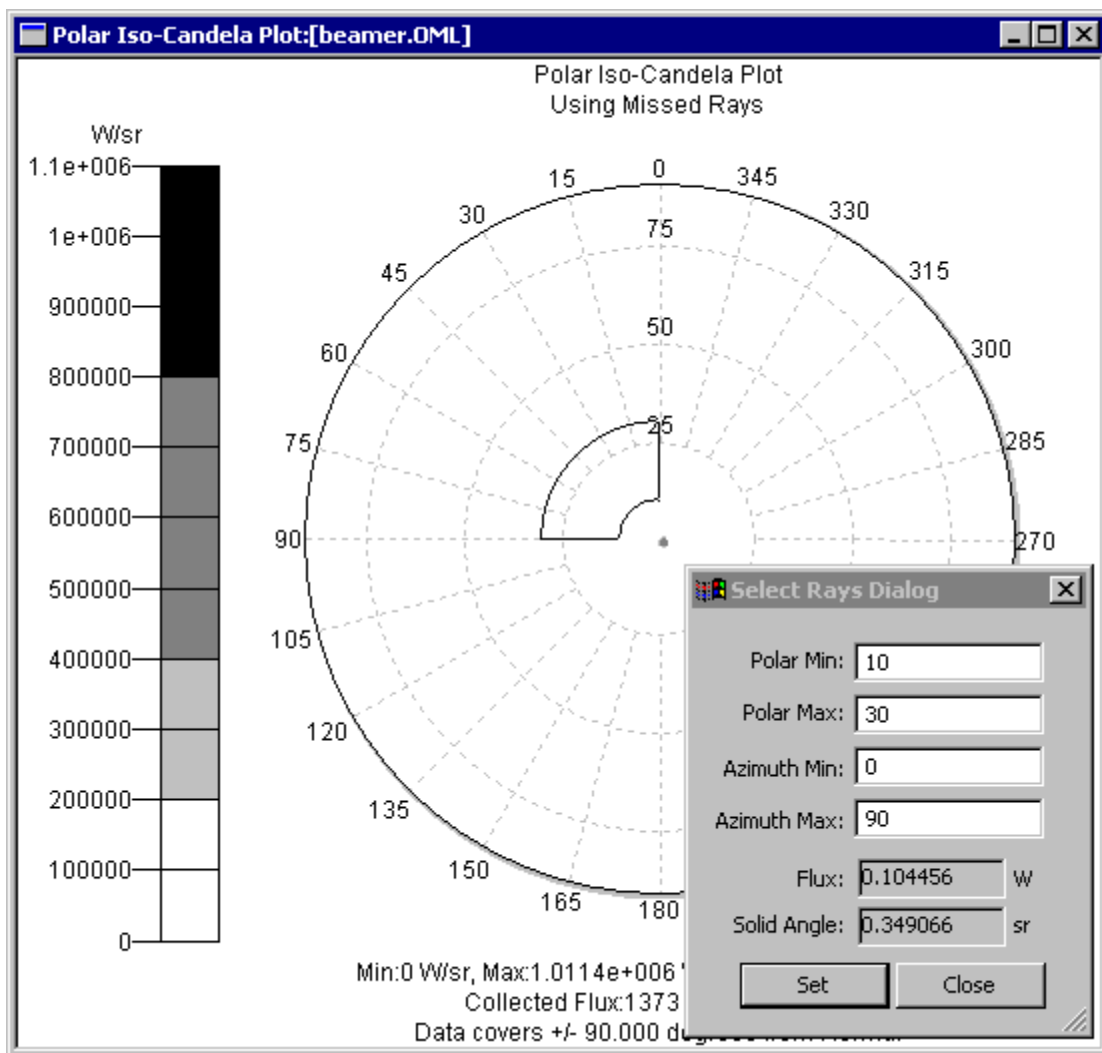
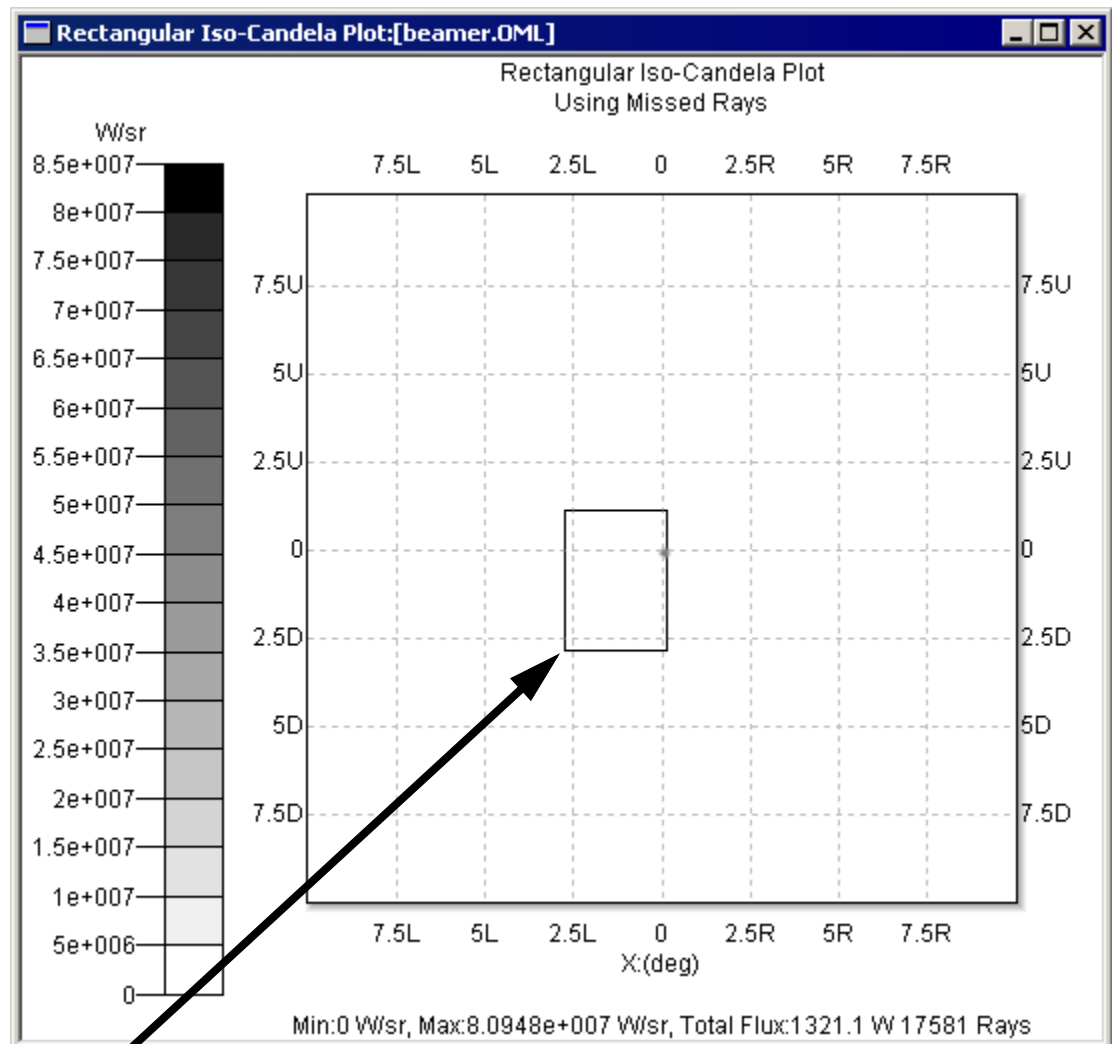

FIGURE 6.28 - Selecting a ray region in a Polar Iso-Candela plot.

Rectangular Iso-Candela

To select a region in the plot, Hold down the SHIFT key, then left-click and drag on the plot to select the “ensquared” area.



Region Selection

FIGURE 6.29 - Enclosed Region and Ensquared Flux

The flux and area are displayed in the status bar of the main TracePro window.

Display Selected Paths

This feature enables you to visualize the rays along selected paths. To use the feature, first select a surface then from the **Analysis Menu** select **Path Sort Table**. Finally select one or more paths, and the ray display will be updated to show only the rays along the selected paths. If the **Irradiance/Illuminance Map** is open, its display will also be updated using only the rays along the selected paths. For a Simulation Mode raytrace, only one ray representing each path will be displayed.

Display Selected Rays

This feature allows you to visualize the rays that contribute to a portion of the Irradiance/Illuminance Map or Isocandela Plot, and is only available after an Analysis Mode raytrace. To activate this feature, go to the **Analysis** Menu and check **Display Selected Rays**. Then select a region using **Analysis|Select Rays...** or graphically select a region on the **Irradiance/Illuminance Map** or **Rectangular Isocandela Plot**. The Model Window will update to display only those rays in the selected region.

NOTE: The Display Selected Paths feature takes priority over the Display Selected Rays feature. This means that when the Display Selected Paths feature is turned on, the Display Selected Rays feature will automatically be turned off and disabled.

Select Rays Dialog

You can also enter the selected region manually through the Select Rays Dialog. This is a requirement for Polar Iso-Candela plots. Open the dialog from the **Analysis|Select Rays...** menu. Enter the new region corners and press the Set button to update the selection and show the new flux and area.

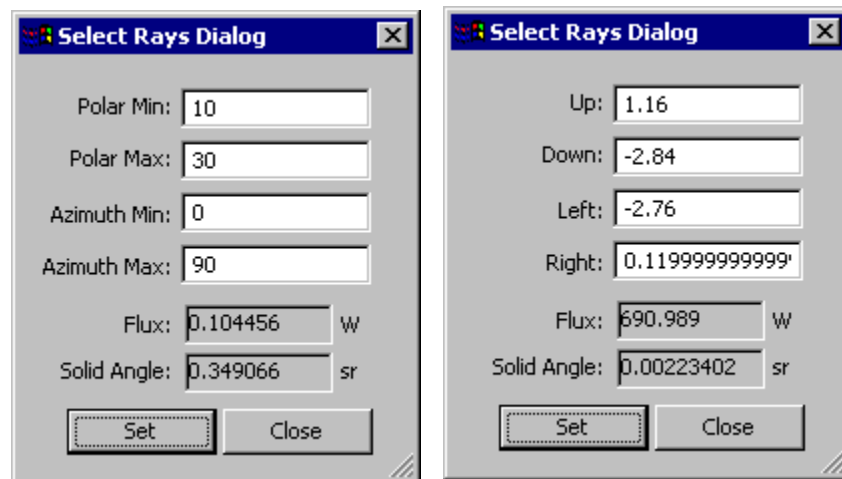

FIGURE 6.30 - Select Rays Dialogs for Polar (L) and Rectangular (R) Iso-Candela Plots.

Polarization Maps Standard Expert

This command maps the polarization ellipse for the incident flux on to the selected surface. The color level shows the degree of polarization at the point on the surface. The polarization maps in Figure 6.31 show the input and output faces of a quarter-wave plate. The object is illuminated using a ray grid with 45 degree linear polarization.

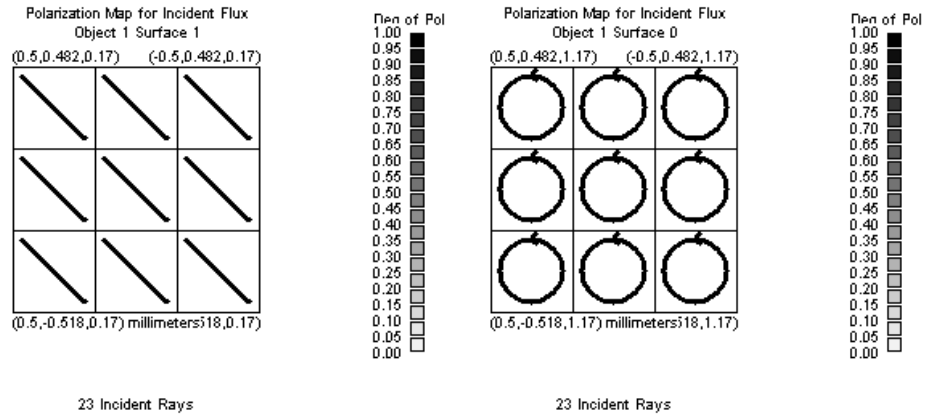

FIGURE 6.31 - Polarization Maps

Note: Polarization must be enabled from the **Analysis | Raytrace Options** dialog, Options tab.

Polarization Options

The following options are available for the polarization plots and accessed from the dialog shown in Figure 6.32.

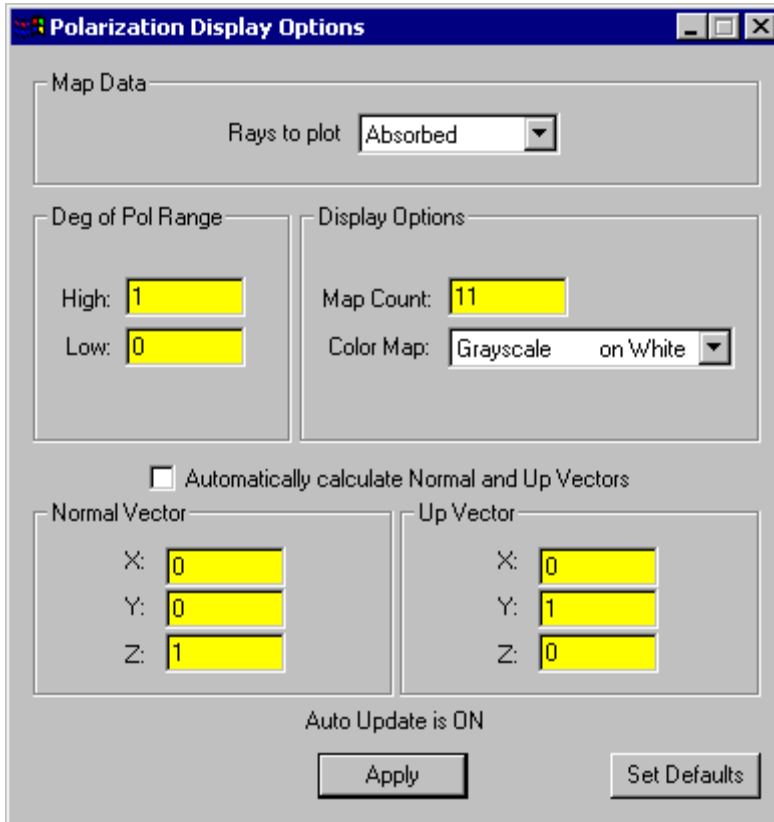

FIGURE 6.32 - Polarization Options dialog.

Rays to Plot

You can observe a map of either absorbed or incident rays.

Deg of Pol Range

Sets the maximum and minimum range for which the degree of polarization is to be plotted.

Map Count

Sets the resolution of the map. The selected surface is divided into Map Count by Map Count regions or “Flux buckets” for the horizontal and vertical axes. The rays are sorted into the buckets and the polarization is summed. The resulting polarization direction is displayed for each bucket in the plot.

Color Map

Selects the color palette for the plot. Grayscale and color palettes are available.

Automatic calculation

Enable automatic calculation of the Normal and Up vectors. See “Normal and Up Vectors” on page 5.14.

Normal Vector

Defines the normal to the plane of the polarization map. Non-planar surfaces will be projected onto a plane for polarization maps. For more information, See “Normal and Up Vectors” on page 5.14.

Up Vector

Defines the up vector to the plane of the polarization map. The up vector defines the “vertical axis” of the displayed map. Non-planar surfaces will be projected onto a plane for polarization map. See “Normal and Up Vectors” on page 5.14.

Apply

Update the map options and display the new polarization map.

Set Defaults

The options are saved when the Model is written to disk in an OML file. After the data is changed, pressing the Set Defaults button with stored the data into the TracePro defaults files to be used the next time TracePro is opened. See “User Defaults” on page 1.11.

Save Polarization Data

Data from a polarization map can be saved to a text file via the **File|Save As** menu. The data is comprised of a short header and the four values from the Stokes vector at each map cell. Each Stokes vector is contained between a set of parentheses.

The following output shows a portion of the data with four data rows with only one of the data columns visible.

```
TracePro Release: 3 2 0
Polarization Map Data for

Data for Object 5 Surface 5
Data generated at 11:37:54 March 19, 2004

(0.81661021,-0.14907119,-0.09443592,0.00000000) (.....)
(0.81877151,-0.16808156,-0.04879953,0.00000000) (.....)
(0.81948364,-0.17453937,-0.00000000,0.00000000) (.....)
(0.81877151,-0.16808156,0.04879953,0.00000000) (.....)
```

OPL/Time-of-flight plot

This command creates a plot of flux incident or absorbed at the selected surface per unit of optical path length (OPL) or time of flight. The OPL is the total optical path along each ray from the source to selected surface. Likewise, the time of flight is the total time it takes for light to propagate along the ray path from the source to the selected surface. The OPL and time of flight in a homogeneous, isotropic material are related to each other by the speed of light,

$$\text{OPL} = ct,$$

where c is the speed of light in vacuum and t is the time of flight. An example OPL/time-of-flight plot is shown in Figure 6.33.

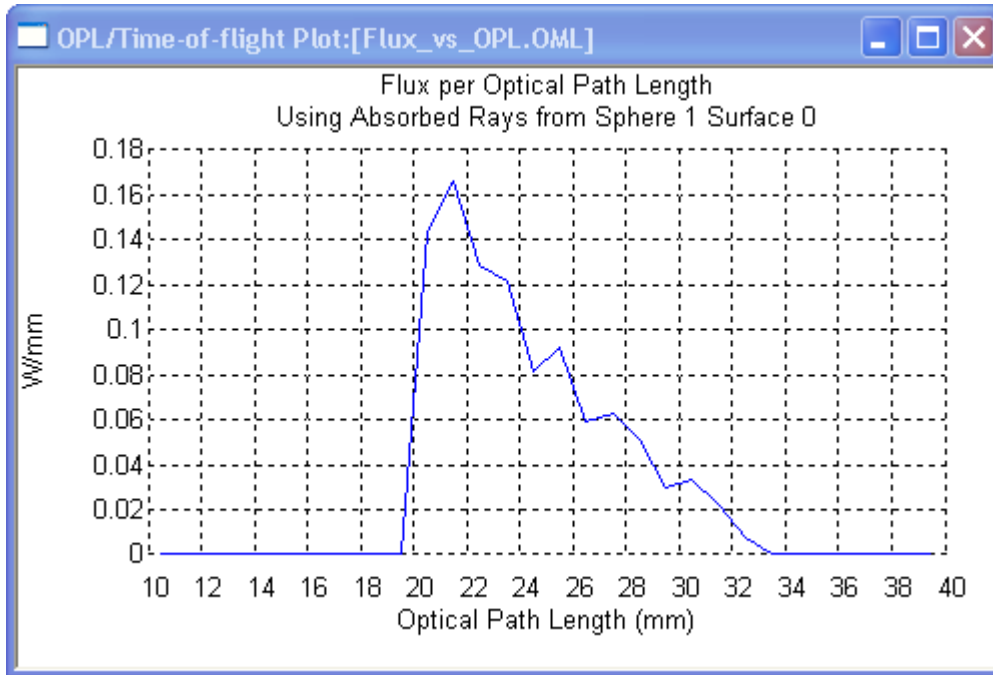

FIGURE 6.33 - OPL/time-of-flight plot.

OPL/Time-of-flight plot options

You can change the OPL/time-of-flight plot using the OPL/time-of-flight Plot Options dialog box, as shown in Figure 6.34. Select Analysis|OPL/Time-of-flight Plot Options, or right-click on the OPL/Time-of-flight plot and select the OPL/Time-of-flight Options to open the dialog box.

To aid in setting the Min Length and Max Length (or Min Time and Max Time) to values that are meaningful for your model, you can use the Ray History Table on the surface of interest. (See "Ray Histories" on page 6.55.) Look at several rays and notice the value of the OPL at the selected surface (the bottom row in each table) to judge the range of OPL values that are of interest for the current surface.

Some of the settings in the Options dialog are redundant, i.e. they depend on other settings. The length and time entries (Min, Max, and Increment) depend on each other through the relation $OPL = ct$. For example, if you change the Min Length setting, the Min Time setting will automatically change per this relation. Also, the Max, Increment, and # of Increments settings are interdependent. If you change the # of Increments value, the Max Length and Max Time settings will change. Conversely, when you change the Max Length or Max Time, the # of Increments will automatically change. Finally, when you change the Length Increment or Time Increment, the # of Increments value will change.

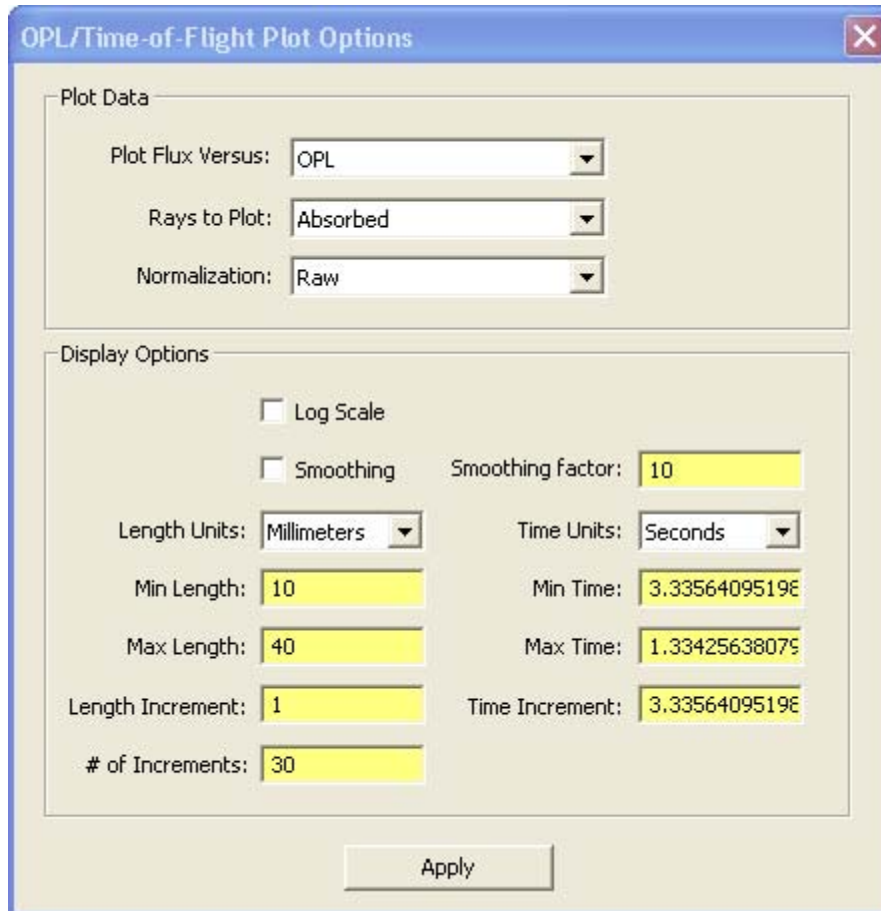

FIGURE 6.34 - OPL/time-of-flight plot options dialog box.

Plot Flux Versus

You can plot flux versus OPL or time of flight

Rays to Plot

You can plot absorbed or incident rays

Normalization

You can choose to display the flux unnormalized (raw) or normalized to emitted flux, incident flux, or absorbed flux.

Log Scale

You can display the flux axis with logarithmic spacing of flux values.

Smoothing

You can smooth the curve of flux versus OPL/time-of-flight.

Smoothing factor

The smoothing factor determines how much smoothing occurs when smoothing is selected. The curve will be smoothed with a blur width that is inversely

proportional to this number. For example, if a factor of 10 is used, the blur width is 1/10 of the length of the horizontal (OPL or time) axis.

Length Units

If Flux versus OPL is selected, this setting determines the units on the horizontal axis of the plot.

Min Length

If Flux versus OPL is selected, this setting determines the minimum value on the horizontal axis of the plot.

Max Length

If Flux versus OPL is selected, this setting determines the maximum value on the horizontal axis of the plot. This setting is affected by the # of Increments setting.

Length increment

If Flux versus OPL is selected, this setting determines the length increment for binning the flux versus optical path length.

of Increments

The number of OPL or time increments that are used to collect the flux, i.e. the bin size. This setting is affected by the Max Length and Max Time settings.

Time Units

If Flux versus time of flight is selected, this setting determines the units on the horizontal axis of the plot.

Min Time

If Flux versus time of flight is selected, this setting determines the minimum value on the horizontal axis of the plot.

Max Time

If Flux versus time of flight is selected, this setting determines the maximum value on the horizontal axis of the plot. This setting is affected by the # of Increments setting.

Time Increment

If Flux versus time of flight is selected, this setting determines the time increment for binning the flux versus time of flight.

Save OPL/Time-of-flight plot

Data from an OPL/Time-of-flight map can be saved to a text file via the **File | Save As** menu. The data is comprised of a header and a two-column table with the values of flux versus OPL or time of flight.

The output below shows a portion of the data with four data rows with only one of the data columns visible.

Finally, you can also save plot image as a bitmap. To do this, select **File | Save As** and choose *Files of type:* bitmap.

TracePro Release: 5 0 0

Flux vs Optical Path Length Data for
 E:\TraceProData\testdata\Flux_v_OPL\Flux_vs_OPL.OML
 Data for Absorbed rays from Sphere 1 Surface 0
 Data generated at 14:30:53 January 06, 2009

Normalization:Raw
 Smooth:Off
 Smooth Factor:10
 Log Scale:Off
 Length Units:Millimeters
 Time Units:Seconds
 Max Length:40
 Min Length:10
 Length Increment:1
 Max Time:1.33426e-010
 Min Time:3.33564e-011
 Time Increment:3.33564e-012
 Number of Increments:30

OPL	Flux
10.5	0
11.5	0
12.5	0
13.5	0
14.5	0
15.5	0
16.5	0
17.5	0
18.5	0
19.5	0
20.5	0.143911
21.5	0.166052
22.5	0.129151
23.5	0.121771
24.5	0.0811808
25.5	0.0922509
26.5	0.0590406
27.5	0.0627306
28.5	0.0516605
29.5	0.0295203

Incident Ray Table

The Incident Ray Table shows data for rays incident on the selected surface. The table can be scrolled, printed, copied to the Windows clipboard for pasting into another application, or saved to a file. The saved file can also be formatted as a TracePro ray file for making a File Source.

An incident ray table can be viewed for any surface in the model. To view an incident ray table:



- choose the **Edi t | Sel ect Surface** menu item or press the Select Surface toolbar button,
- select the surface for which you want to see the incident ray table,
- choose **Anal ysi s | I nci dent Ray Tabl e**.

A new window, Figure 6.35, opens with a table rays incident on the surface. To view the incident ray table for another surface, select that surface with the mouse and the ray table will automatically update to show the rays at that surface.

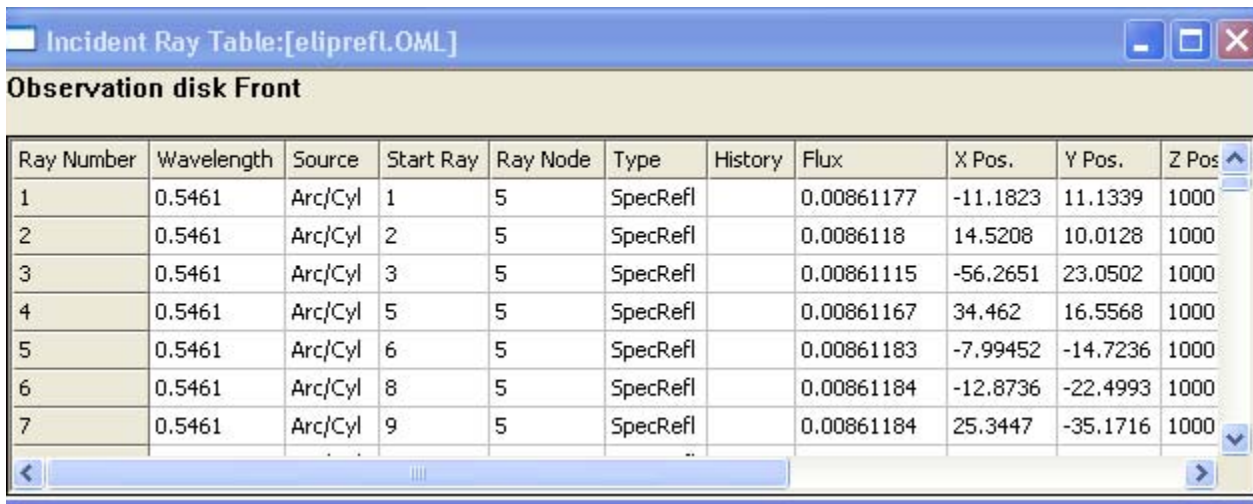

Ray Number	Wavelength	Source	Start Ray	Ray Node	Type	History	Flux	X Pos.	Y Pos.	Z Pos.
1	0.5461	Arc/Cyl	1	5	SpecRefl		0.00861177	-11.1823	11.1339	1000
2	0.5461	Arc/Cyl	2	5	SpecRefl		0.0086118	14.5208	10.0128	1000
3	0.5461	Arc/Cyl	3	5	SpecRefl		0.00861115	-56.2651	23.0502	1000
4	0.5461	Arc/Cyl	5	5	SpecRefl		0.00861167	34.462	16.5568	1000
5	0.5461	Arc/Cyl	6	5	SpecRefl		0.00861183	-7.99452	-14.7236	1000
6	0.5461	Arc/Cyl	8	5	SpecRefl		0.00861184	-12.8736	-22.4993	1000
7	0.5461	Arc/Cyl	9	5	SpecRefl		0.00861184	25.3447	-35.1716	1000

FIGURE 6.35 - Incident Ray Table.

The incident ray table displays the columns shown in Table 6.5.

At each ray intersection a Intercept Type is stored in the ray node. The ray types are listed in Table 6.3.

TABLE 6.3. Ray Intercept Types.

Label	Description
SpecTran	Specular Transmission
SpecRef	Specular Reflection
RandTran	Random Transmission (e.g. Scatter, Diffraction, etc.)
RandRefl	Random Reflection (e.g. Scatter, Diffraction, etc.)
ImpTran	Importance Transmission (from Importance Sampling)
ImpRefl	Importance Reflection (from Importance Sampling)
RanDiffTran	Diffraction in Transmission
RanDiffRefl	Diffraction in Reflection
ImpDiffTran	Diffraction in Transmission (from Importance Sampling)
ImpDiffRefl	Diffraction in Reflection (from Importance Sampling)
RanVolume	Node in bulk scattering object.
ImpVolume	Node in bulk scattering object (from Importance Sampling)
GrinTran	Node inside a Grin Object
RepTileTran	Node inside a RepTile surface
TIR	Total Internal Reflectance

Additional information is stored for certain conditions and displayed under the History column. These are shown in Table 6.4.

TABLE 6.4. Ray History Types.

Label	Description
OpticalScat	Optical Scatter threshold reached
RandomScat	Random Scatter threshold reached
TotalIcepts	Total Intercept threshold reached
TotalScat	Total Scatter threshold reached
Emitted	Starting node at emitted surface
Edge Hit	Ray failed at an edge
Coinc Surf	Ray intersected two coincident surfaces
TIR	Ray reflected due to TIR
Missed	Ray missed all surface
Volume Scat	Ray in a bulk scattering object
RepTile	Ray in a RepTile surface

An algorithm is used to determine if a ray intersected two coincident surfaces, by first calculating how far apart the two intersection points are, then comparing to a

tolerance. The tolerance varies depending on the particular intersection, but the smallest tolerance value is 1.0e-6 mm (1 nm).

Each sheet in the Incident Ray Table displays the columns listed in Table 6.5 with additional columns for polarization data if polarization raytrace is enabled.

TABLE 6.5. Incident Ray Table Columns

Label	Description	Polarization Ray Trace
Ray Number	The row in the table	
Wavelength	The wavelength for the current ray	
Source	The name of the source from which this ray started	
Start Ray	For example, Start Ray 3 is the third ray started in the raytrace.	
Ray Node	The ray starts with ray node 1 (at the source or grid) and the first ray-surface intersection is node 2, etc.	
Type	The type of the previous ray node, for example, SpecRefl for specular reflection.	
History	Often blank. Any special type of the previous node, for example, TIR for total internal reflection—a totally internally reflected ray on the previous node is Type=SpecRefl and History=TIR.	
Flux	Flux of the incident ray.	
X Pos., Y Pos., Z Pos.	X, Y, and Z coordinates where the ray struck the surface.	
X Vec., Y Vec., Z Vec.	X, Y, and Z direction cosines of the ray incident on the surface.	
S0, S1, S2, S3	Components of the Stokes vector in the local coordinate system of the ray.	enabled
Deg Pol	Degree of polarization of the ray.	enabled
Ellipse Ratio	Ratio between the two axes of the polarization ellipse.	enabled
Xvec MajAxis, Yvec MajAxis, Zvec MajAxis	X, Y, and Z components of a vector pointing in the direction of the major axis of the polarization ellipse.	enabled

Copying and Pasting the Incident Ray Table Data

The incident ray table data can be exported from TracePro to another software package such as a spreadsheet or word processor. Do this by making the incident ray table window the active window and selecting **Edi t | Copy** in TracePro (or Ctrl-C). Go to the other software program, such as Microsoft Excel, and select **Edi t | Paste** (or Ctrl-V). The tabular data is transferred to the other program via the Windows clipboard.

Saving the Incident Ray Table in a File

You can also save the incident ray table in a text file. Then you can import the table into a spreadsheet program, for example, or perform post-processing operations using your own or other analysis software. To do this, first be sure the incident ray table is activated (as indicated by a colored top bar on the Incident Ray Table window), then select **FI le | Save As**. The default extension for the file is

txt. Type the file name you wish to use and press OK. TracePro saves a tab-delimited file containing the incident ray table.

When you save the incident ray table to a file, additional data columns are saved to the file as shown in Table 6.6. The wavelengths are displayed as head lines.

TABLE 6.6. Incident Ray Table Columns: These columns are available when the table is saved to a format outside of TracePro for post-processing.

Ray Number	The row in the table
Start Number	For example, start Number 3 is the third ray started in the ray-trace.
Split Number	The ray starts with split number 1 (at the source or grid) and the first ray-surface intersection is split number 2, etc.
Type	This refers to the type of the ray node, e.g. SpecRefl for specular reflection.
Hist	This is often blank. It refers to any special type of the previous node, e.g. TIR for total internal reflection. Thus a totally internally reflected ray on the previous node would result in Type=SpecRefl and Hist=TIR.
Inc Flux	Flux of the ray incident on the surface in Watts or Lumens.
Abso Flux	The portion of the incident flux of the ray that was absorbed by the surface in Watts or Lumens.
X Pos., Y Pos., Z Pos.	The global coordinates where the ray struck the surface.
X Vec., Y Vec., Z Vec.	The global direction cosines of the incident ray.
X Norm, Y Norm, Z Norm	The normal to the surface at the position where the ray struck the surface.
S0, S1, S2, S3	The Stokes vector of the incident ray (polarization only).
DegOfPol	The degree of polarization of the incident ray (polarization only)
Ellipse Ratio	Ratio between the two axes of the polarization ellipse
Xvec MajAxis, Yvec MajAxis, Zvec MajAxis	X, Y, and Z coordinates of a vector pointing in the direction of the major axis of the polarization ellipse.

Saving the Incident Ray Table as a Ray File

A TracePro ray file can be created from an Incident Ray Table, for use in defining a File Source. With the Incident Ray Table as the active window, select **File | Save As**, choose the file format as ***.txt**, and check the box for “Export to Ray File format. The ray file saved from the Incident Ray Table will always be saved as Radiometric units. If TracePro is set to Photometric units, the data will be converted to Radiometric units when it is saved as a ray file. For more information on ray files and their applications, see the section titled >“File Sources” on page 5.22.

Display Selected Rays

The menu command **Analysis | Display Selected Rays** causes TracePro to turn off the regular ray display and draw the rays selected by row in the Incident Rays Table. One or more rows can be selected using the mouse with the <Shift> or <Ctrl> key. To select a set of continuous rows, click in the first row and then,

Analysis

with the <Shift> key pressed, click in the last row. You can select individual rows (discontinuous items) by clicking in each row with the <Ctrl> key pressed. An example is shown in Figure 6.36 and Figure 6.37.

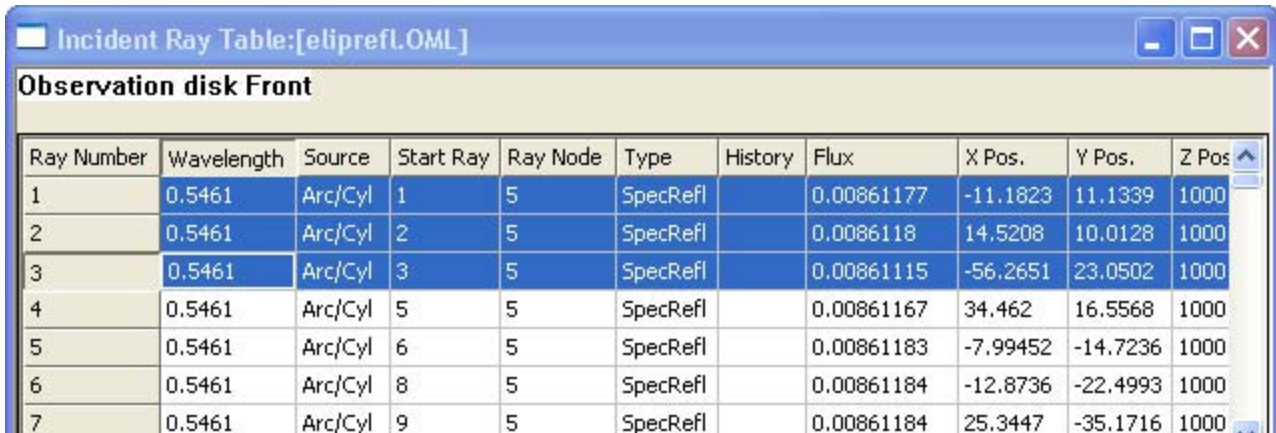

Incident Ray Table:[eliprefL.OML]

Observation disk Front

Ray Number	Wavelength	Source	Start Ray	Ray Node	Type	History	Flux	X Pos.	Y Pos.	Z Pos.
1	0.5461	Arc/Cyl	1	5	SpecRefl		0.00861177	-11.1823	11.1339	1000
2	0.5461	Arc/Cyl	2	5	SpecRefl		0.0086118	14.5208	10.0128	1000
3	0.5461	Arc/Cyl	3	5	SpecRefl		0.00861115	-56.2651	23.0502	1000
4	0.5461	Arc/Cyl	5	5	SpecRefl		0.00861167	34.462	16.5568	1000
5	0.5461	Arc/Cyl	6	5	SpecRefl		0.00861183	-7.99452	-14.7236	1000
6	0.5461	Arc/Cyl	8	5	SpecRefl		0.00861184	-12.8736	-22.4993	1000
7	0.5461	Arc/Cyl	9	5	SpecRefl		0.00861184	25.3447	-35.1716	1000

FIGURE 6.36 - Incident Ray Table set to display selected rays

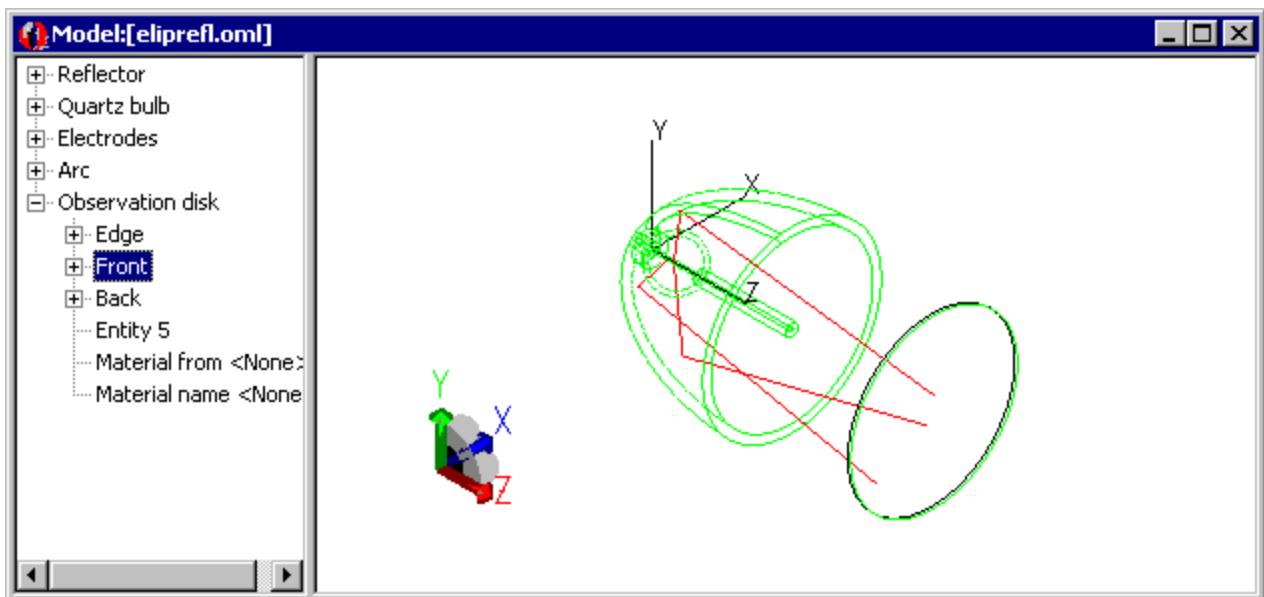

FIGURE 6.37 - Model with rays selected from the Incident Ray Table

Path Sorting

Path Sorting can be applied to the Incident Ray Table. To use Path Sorting with the Incident Ray Table, select a surface, then select **Analysis|Path Sorting**, and then select **Analysis|Incident Ray Table**. Next, select the path in the Path Sort Table that you wish to display and select **Analysis|Display Selected Paths**.

Ray Files - Binary file format

Ray files saved in ASCII file format (.txt files) may be excessively large. TracePro supports ray files in binary format, which result in smaller file sizes.

When saving a binary ray file from an Incident Ray Table, select the “Save As type” as “Binary ray file (*.src)” as shown in Figure 6.38.

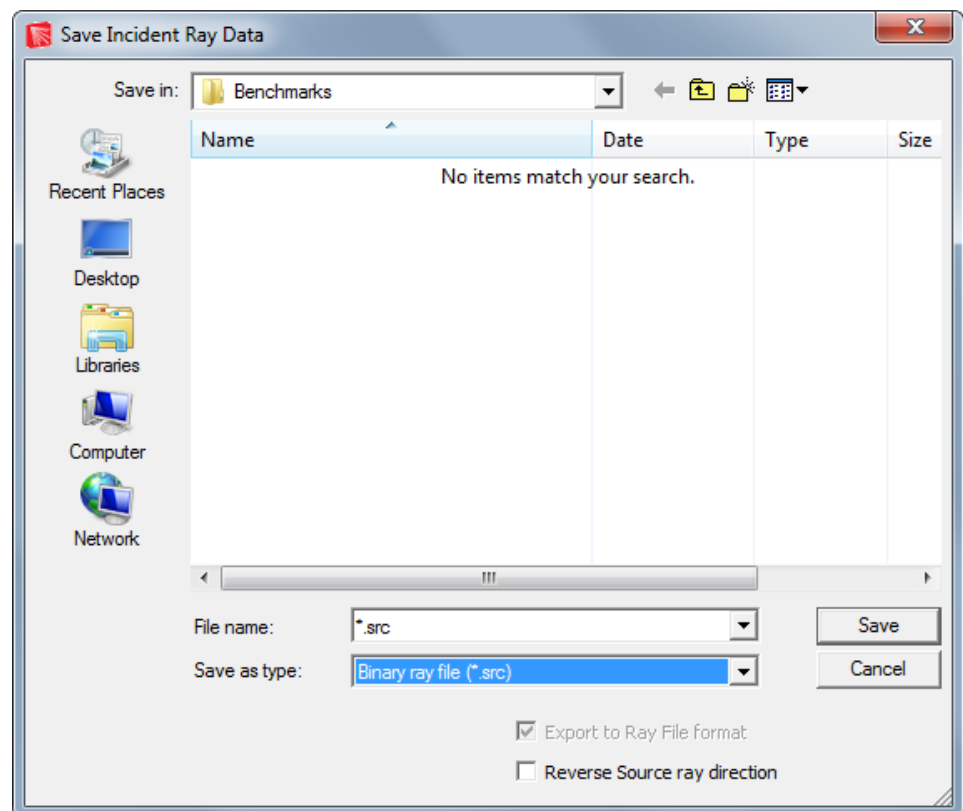

FIGURE 6.38 - Save Incident Ray Data dialog illustrating Binary Ray File format

Ray files saved in Binary Ray File format can be inserted into a TracePro model as described in the section “Insert Source” on page 5.23.

Ray Histories

The Ray History Table window, as shown in Figure 6.39, displays the incident ray direction, intercept coordinates, incident flux, optical path length, and the object and surface names for the entire path of each ray as it strikes each surface along the path. Each ray path history is displayed on its own sheet in the Ray History Table window. Each ray history sheet can be scrolled using the usual cursor controls, and you can view other sheets containing other ray histories using **Analysis|Ray Select|Next Ray** and **Analysis|Ray Select|Previous Ray**, or by using **Alt+PgDn** and **Alt+PgUp**, respectively. The Navigator buttons can be used to select the ray. The navigator allows you to select the first ray (|<), previous

ray (<), next ray (>), or last ray (>|). You can also insert the ray number and press the Enter key to display a specific ray.

Wavelength	Ray Node	Start Ray	X Pos.	Y Pos.	Z Pos.	Flux	OPL	X Vec.
0.5461	1	1	1.83281	4.65197	85.3287	0.01	0	0.307533
0.5461	2	1	21.9164	63.6825	65.9156	0.01	65.3056	0.309542
0.5461	3	1	26.5601	77.275	61.5878	0.00952772	88.6381	0.307889
0.5461	4	1	39.3609	114.872	49.293	0.00907774	130.214	-0.0473943
0.5461	5	1	-6.1505	-12.4345	1000	0.00861184	1090.49	0

FIGURE 6.39 - Ray History Table

The Ray History Table window can be viewed for any surface in the model. To view a ray history table:



- choose the **Edit | Select Surface** menu item or press the Select Surface toolbar button,
- select the surface for which you want to see the ray history table,
- choose **Analysis | Ray Histories**.

A new window opens with a ray history table for that specified surface. To view the ray history table at another surface, select that surface with the mouse and the ray table will be updated to show the rays at that surface.

Each sheet in the Ray History Table displays the columns listed in Table 6.7 with additional columns for polarization data if polarization raytrace is enabled.

TABLE 6.7. Ray History Table Columns

Label	Description	Polarization Ray Trace
Wavelength	Wavelength for the current ray	
Ray Node	The ray starts with ray node 1 (at the source or grid) and the first ray-surface intersection is node 2, etc.	
Start Ray	Start Ray 3 is the third ray started in the raytrace, for example.	
X Pos., Y Pos., Z Pos.	X, Y, and Z coordinates where the ray struck the surface	
Flux	Flux of the incident ray.	
OPL	Optical path length of the ray, cumulative from the source—the integral of the distance along the ray times the index of refraction	
X Vec., Y Vec., Z Vec.	Direction cosines of the departing ray	
Type	SpecRefl for specular reflection, for example. See Table 6.3 on page 6.51.	
History	Often blank. It refers to any special type of the ray node. For example, TIR for total internal reflection. A totally internally reflected ray on the ray node results in Type=SpecRefl and History=TIR. See Table 6.4 on page 6.51.	
Object	Name of the object at the current ray node	
Surface	Name of the surface at the current ray node	
S0, S1, S2, S3	Components of the Stokes vector in the local coordinate system of the ray	enabled
Deg Pol	Degree of polarization of the ray	enabled
Ellipse Ratio	Ratio between the two axes of the polarization ellipse	enabled
Xvec MajAxis, Yvec MajAxis, Zvec MajAxis	X, Y, and Z coordinates of a vector pointing in the direction of the major axis of the polarization ellipse	enabled

Copying and Pasting the Ray History Table Data

The ray history table data can be easily exported from TracePro to another software package such as a spreadsheet or word processor. First, be sure the ray history table window is the active window. Select **Edi t | Copy** in TracePro (or Ctrl-C). Switch to the other application and select **Edi t | Paste** (or Ctrl-V). The tabular data is transferred to the other program via the Windows clipboard.

Saving the Ray History Table in a File

You can also save the ray history table in a text file. Then the table can be imported into a spreadsheet program, for example, or you can perform post-processing operations using your own or other analysis software. To do this, first be sure the ray history table is the active window (as indicated by a colored top bar on the top of the window), then select **FI l e | Save As**. The default extension for the file is **txt**. Type the file name you wish to use and press OK. TracePro saves a tab-delimited file containing the ray history table.

When you save the ray history table to a file, additional data columns are included as shown in Table 6.8. The start ray number and the wavelength are given as header lines. The columns are as follows:

TABLE 6.8. Ray History Table Columns: These columns are available when the table is saved to a format outside of TracePro for post-processing.

Ray Node	The ray starts with ray node 1 (at the source or grid) and the first ray-surface intersection is node 2, etc.
Flux	Flux of the incident ray.
OPL	The optical path length of the ray, cumulative from the source. This is the integral of the distance along the ray times the index of refraction.
X Pos., Y Pos., Z Pos.	The X, Y, and Z coordinates where the ray struck the surface.
X Vec., Y Vec., Z Vec.	Direction cosines of the departing ray.
Type	Kind of ray node, for example, SpecRefl for specular reflection.
Hist	Often blank. Any special type of the ray node, for example, TIR for total internal reflection—a totally internally reflected ray on the ray node would result in Type=SpecRefl and History=TIR.
Object	Name of the object at the current ray node
Surface	Name of the surface at the current ray node
S0, S1, S2, S3	Components of the Stokes vector in the local coordinate system of the ray
Deg Pol	Degree of polarization of the ray
Ellipse Ratio	Ratio between the two axes of the polarization ellipse
Xvec MajAxis, Yvec MajAxis, Zvec MajAxis	X, Y, and Z coordinates of a vector pointing in the direction of the major axis of the polarization ellipse

Ray Sorting



Ray Sorting affects the display of rays in the model window and may be applied to plots and tables. To open the Ray Sorting dialog box, select **Analysis | Ray Sorting**. The default display of rays is All Rays, which displays all the branches of every ray traced. The display of rays is not altered until you click the Update button.

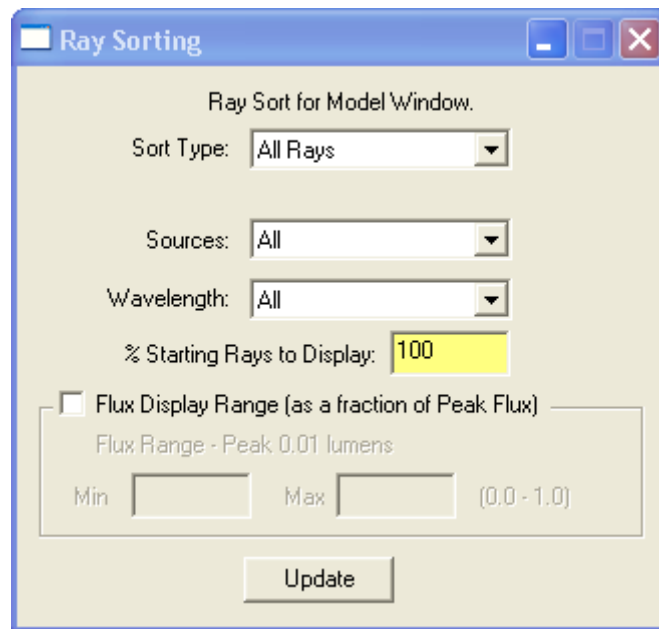

FIGURE 6.40 - Ray Sorting Dialog

All the Sort Type options in the Ray Sorting dialog box, except All Rays, require you to select a surface before any sorting is done. Table 6.9 summarizes the choices in Sort Type.

TABLE 6.9. Summary of Sort Type choices in Ray Sorting dialog box

Sort Type	Meaning	Surface Selection Required?
All Rays	All rays are displayed.	No
Selected Surface	Only rays hitting the selected surface are displayed.	Yes
Specular	Only rays hitting the selected surface that undergo only specular reflections or refractions along the way are displayed. Scattered rays are not displayed.	Yes
Single Surface Scatter	Only rays hitting the selected surface that undergo exactly one surface scatter along the way are displayed.	Yes
Multiple Surface Scatter	Only rays hitting the selected surface that undergo more than one surface scatter along the way are displayed.	Yes
Single Bulk Scatter	Only rays hitting the selected surface that undergo exactly one bulk scatter along the way are displayed.	Yes
Multiple Bulk Scatter	Only rays hitting the selected surface that undergo more than one bulk scatter along the way are displayed.	Yes
Single Diffraction	Only rays hitting the selected surface that undergo exactly one aperture diffraction along the way are displayed.	Yes
Multiple Diffraction	Only rays hitting the selected surface that undergo more than one aperture diffraction along the way are displayed.	Yes

The display of rays can also be sorted by source and by wavelength. The default selections are for all wavelengths to be displayed. When Fluorescence is included in the ray trace individual wavelengths are marked with Ex for Excitation and Em for Emission showing how the rays contribute to the simulation. See “Fluorescence Ray Trace” on page 3.15.

The percentage of starting rays to display can also be entered. This is useful when you have done a raytrace with many rays. In such a case, there can be so many rays that you cannot get any useful insight from the display. The default percentage to display is 100%.

The Flux Display Range option can be used to control which rays are displayed by the relative flux of the rays. The flux of each ray segment is divided by the starting flux of the ray. If the result is between the Min and Max values, the ray segment will be displayed. The default is for all ray segments will be displayed. To modify the Flux Display Range settings, check the Flux Display box in the Ray Sorting dialog box. You can input values for the Flux Range to eliminate the display of rays outside of the selected range.

NOTE: Ray Sorting does not apply to Candela Plots nor 3D Irradiance Maps.

Export Rays

After you have done Ray Sorting, you can export the sorted rays in any of various CAD file formats. To do this, simply select **File | Export Rays**, select the type of the file to export, and type the name of the file. Finally, click **Save** to save the file.

Ray Sorting Examples

A simple example using a model with two blocks, the As2S3 surface property and polychromatic Grid Source is shown in Figure 6.41.

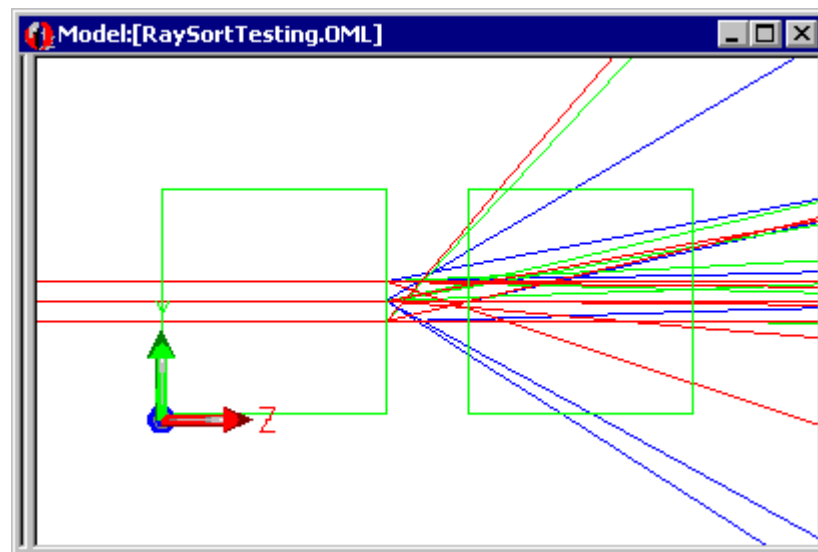

FIGURE 6.41 - Generic model showing scattering of rays on back surface of left block.

The irradiance map for the raytrace from Figure 6.41 for all rays and wavelengths is shown on the left side of Figure 6.42, and the right shows the map for all wavelengths but only Specular rays

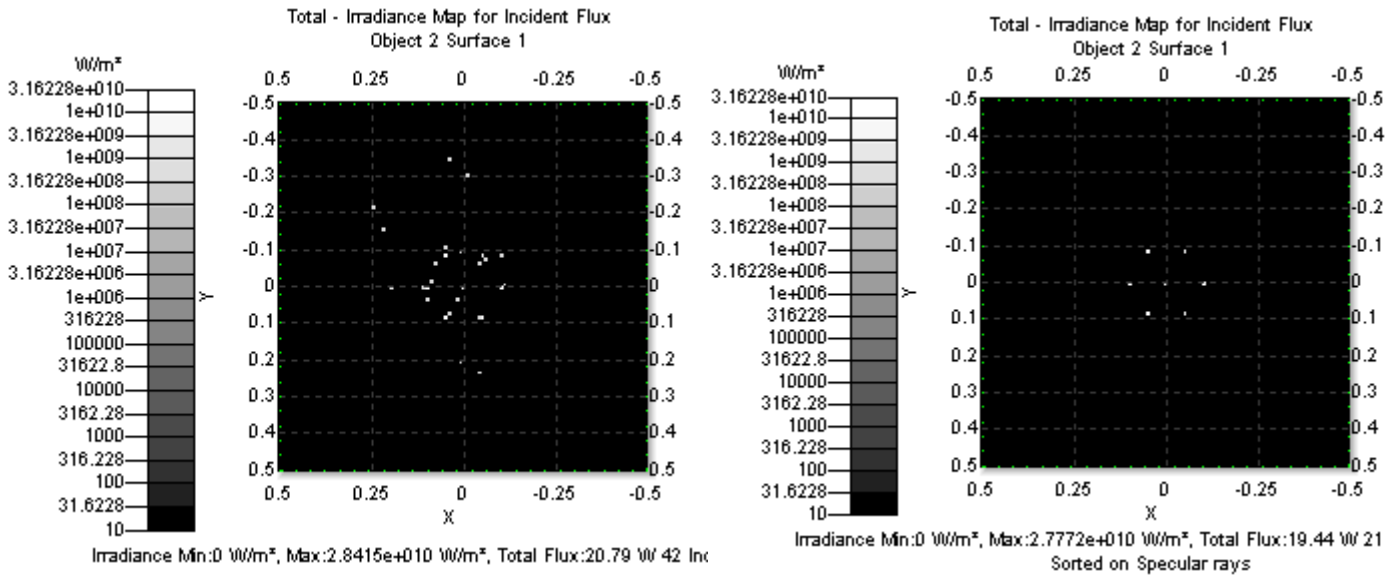

FIGURE 6.42 - TracePro Irradiance maps, All rays (left), Specular rays (right)

The Irradiance Map Ray Sorting dialog is shown in Figure 6.43. Note that the Window to which the sort will be applied is displayed at the top of the dialog.

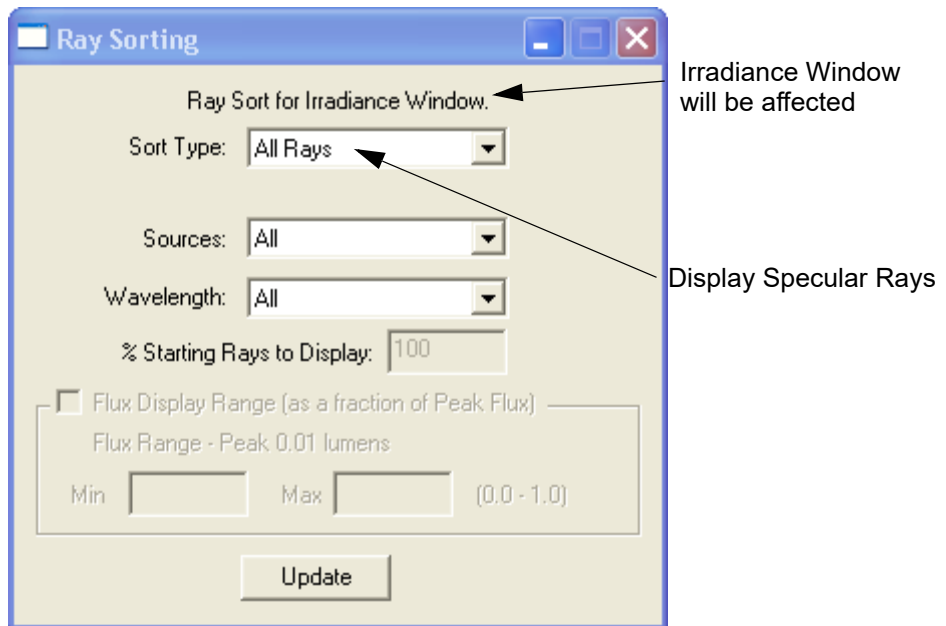

FIGURE 6.43 - Ray Sorting dialog window.

The Incident Ray Table for the raytrace from Figure 6.41 shown in Figure 6.44 but with the Sort Type set to Single Scatter. You can see that the only Intercept type displayed is RandTran (Random Transmission) since a scattering surface precedes the selected surface and any Specular rays suppressed.

Ray Number	Wavelength	Start Ray	Ray Node	Type	History	Flux	X Pos.	Y Pos.	Z Pos.	X Vec.	Y Vec.	Z Vec.	SO
1	0.5461	1	4	RandTran		0.0642695	0.00159545	-0.202538	2.86937	0.00378736	-0.480793	0.876826	0.0
2	0.5461	2	4	RandTran		0.0642695	-0.040363	-0.237049	2.86937	-0.304614	-0.51444	0.8016	0.0
3	0.5461	3	4	RandTran		0.0642695	0.21074	0.157043	2.86937	0.393064	0.172252	0.903233	0.0
4	0.5461	4	4	RandTran		0.0642695	0.0065591	0.0952051	2.86937	0.151319	0.0230155	0.988217	0.0
5	0.5461	5	4	RandTran		0.0642695	0.24314	0.219007	2.86937	0.62426	0.39843	0.671977	0.0
6	0.5461	6	4	RandTran		0.0642695	0.19035	-0.0015963	2.86937	0.535531	0.189405	0.823002	0.0
7	0.5461	7	4	RandTran		0.0642695	0.0357602	-0.0760498	2.86937	-0.0385073	0.0285368	0.998851	0.0
8	1.054	1	4	RandTran		0.0642695	0.0717921	0.0646903	2.86937	0.188035	0.169434	0.967437	0.0
9	1.054	2	4	RandTran		0.0642695	0.0844042	0.0153011	2.86937	-0.0421491	0.0413525	0.998255	0.0
10	1.054	3	4	RandTran		0.0642695	0.048624	0.104213	2.86937	-0.0037211	0.0476231	0.998858	0.0
11	1.054	4	4	RandTran		0.0642695	-0.061438	0.077583	2.86937	-0.0309424	-0.0243998	0.999223	0.0
12	1.054	5	4	RandTran		0.0642695	-0.105725	0.0844413	2.86937	-0.0151077	0.222835	0.974739	0.0
13	1.054	6	4	RandTran		0.0642695	-0.0493014	-0.0879064	2.86937	0.00189131	-0.00353003	0.999992	0.0
14	1.054	7	4	RandTran		0.0642695	-0.017826	0.308574	2.86937	-0.124415	0.724883	0.677544	0.0
15	3	1	4	RandTran		0.0642695	0.0153913	-0.0307308	2.86937	0.0414899	-0.0828403	0.995699	0.0
16	3	2	4	RandTran		0.0642695	0.10568	-0.00345373	2.86937	0.015375	-0.00934883	0.999838	0.0
17	3	3	4	RandTran		0.0642695	0.0444432	0.0814273	2.86937	-0.015041	-0.0140081	0.999789	0.0
18	3	4	4	RandTran		0.0642695	0.0907759	-0.0358275	2.86937	0.340193	-0.295859	0.892601	0.0
19	3	5	4	RandTran		0.0642695	-0.042304	0.0692856	2.86937	0.151746	0.182228	0.971476	0.0
20	3	6	4	RandTran		0.0642695	0.0314839	0.342595	2.86937	0.142433	0.750231	0.645652	0.0
21	3	7	4	RandTran		0.0642695	-0.110554	0.00059887	2.86937	-0.389613	0.211609	0.896339	0.0

FIGURE 6.44 - Incident Ray Table.

Reports Menu

TracePro can generate reports on the raytrace and properties using the **Reports** menu. You can generate a Raytrace report, a Flux report, or a Property Data report. The reports provide summary information after a ray trace or about the property informations in the case of a Property Report.

Flux Report

The Flux report provides a summary of the most recent raytrace. The data can also be saved to a tab-delimited text file for viewing and post-processing in other programs via the **File | Save As** menu.

Data columns include Surface Area, Wavelength and Source, Number of Incident rays, Incident and Absorbed fluxes, and the Lost flux. Lost flux data is broken into various categories to identify which mechanism caused rays to be lost.

Data is displayed for bulk absorption and incident flux for each object. The incident flux is the sum of the flux entering the object so that the ray data is not doubly counted when a ray passes into and out of the object. In the case of a sphere that has a single surface, a ray passing through the sphere will have a incident flux for object at half the value as that of the surface, in the loss less case. The ray is incident on the object once but incident on the surface twice.

The lists at the top of the window allow you to choose which sources and which wavelenths to include in the Flux Report.

The data is displayed for each object in red and for each surface in blue. If you wish to display the report for only a few objects, first select the objects, either in the System Tree or in the Model Window, display the report, and click the *Display Selected Objects* button at the top of the report window. There is also an option to *Only display objects and surfaces with non-zero flux* for absorbed, incident, or lost flux.

Object Name	Material Catalog	Material Property	Surface Name	Surface Catalog	Surface Property	Absorbed	Lost	Number of rays	Incident
						[sq mm]			[lumens]
LED 1	<None>	<None>							0.281176942620518
Emitter	Default	<None>				6.25		302	0.158632492844508
Surface 1	Default	<None>				6.25		305	0.161534387708966
Surface 2	Default	<None>				2.5		114	0.071711694241359
Surface 3	Default	<None>				2.5		102	0.0463162611234435
Surface 4	Default	<None>				2.5		103	0.068313482323218
Surface 5	Default	<None>				2.5		98	0.0558455669995417

FIGURE 6.45 - Flux Report

Property Data Report

This report displays the model's property data. This provides similar information on the Objects and Surfaces as found from the System Tree. The data can be saved to a tab-delimited text file for viewing and post-processing in other programs via the **File | Save As** menu.

The data is displayed for each object in red and for the object's surfaces in blue. If you wish to display the report for only a few objects, first select the objects, either in the System Tree or in the Model Window, display the report, and click the *Display Selected Objects* button at the top of the report window.

Raytrace Report

This report displays a modal dialog with the elapsed raytrace time for the most recent raytrace of the active model.

Saving and Restoring a Raytrace

An analysis mode raytrace can be saved to disk for later display. First, put TracePro into Ray Saving Mode by selecting **File | Save Ray Data**.

This action toggles the Save Ray Data menu item on and off. When the menu item is checked and you save a TracePro model, a second file with the extension **ray** is also saved. The ray file contains data for all the rays from the most recently completed raytrace.

To save ray data, first be sure that TracePro is in ray saving mode. You can check this by looking at the File menu and confirming that the **Save Ray Data** item is checked. (If it appears as , it is checked. Selecting it again makes it unchecked.)

Then select **File | Save As** and type in a file name for the **oml** file. Press Save to save the file, and TracePro will save both the **oml** file and the **ray** file.

It is important that the **oml** file and **ray** file stay synchronized. Changes to the geometry and properties in the **oml** file will make the saved rays obsolete and unrepresentative of the model. Changing the model requires re-running the raytrace.

To restore a saved raytrace, simply open an **oml** file that has an associated **ray** file. TracePro will find and open the ray file at the same time, and display the rays (providing the **Analysis | Display Rays** menu item is checked). Once the rays are restored, you can sort them using **Analysis | Ray Sort** and display irradiance maps and candela plots. However, the Flux Report cannot be generated from the ray file. You must re-run the raytrace to get a flux report.

Tools Menu

Several utility commands are grouped under the Tools menu. These include auditing, geometry conversion, and database utilities. The database items are described in another chapter. See “Property Database Tools” on page 3.83.

Audit

TracePro uses two kinds of audit, an update audit and a full audit.

TracePro Automatically performs an audit as the first part of a raytrace. This automatic audit identifies only what has changed since the previous audit and processes any changed data. If no previous audit data is found, TracePro initiates a full audit.

You can manually initiate a full audit of the current model by selecting the menu option, **Tools | Audit**. You may wish to employ such a “manual” audit prior to a raytrace to locate problems such as flaws in surfaces, surface properties, or other potential problems in the model. Error conditions that are discovered are displayed in the Messages Window.

A manual audit overwrites all previous audit data. That contrasts with an automatic audit in a raytrace, which only updates data that is changed from the previous audit.

Delete Raydata Memory

Selecting Delete Raydata Memory causes TracePro to delete the contents of raytrace memory that is used by the active model. Ray display and other analysis are disabled after making this selection.

Collect Volume Flux

Overview

TracePro has the capability to perform volume flux calculations. From an analysis mode raytrace, the user can describe a set of contiguous rectangular parallelepiped cells. For each of the cells, four (4) flux values are calculated for the given raytrace and the results are saved to a user-specified file. The four categories of flux are: originating flux, incident flux, absorbed flux, and lost flux.

Limitation: The Volume Flux calculation does not work correctly with fluorescent materials or gradient materials.

From the **Tools** menu, select **Collect Volume Flux**. The dialog box shown in Figure 6.46 will appear.

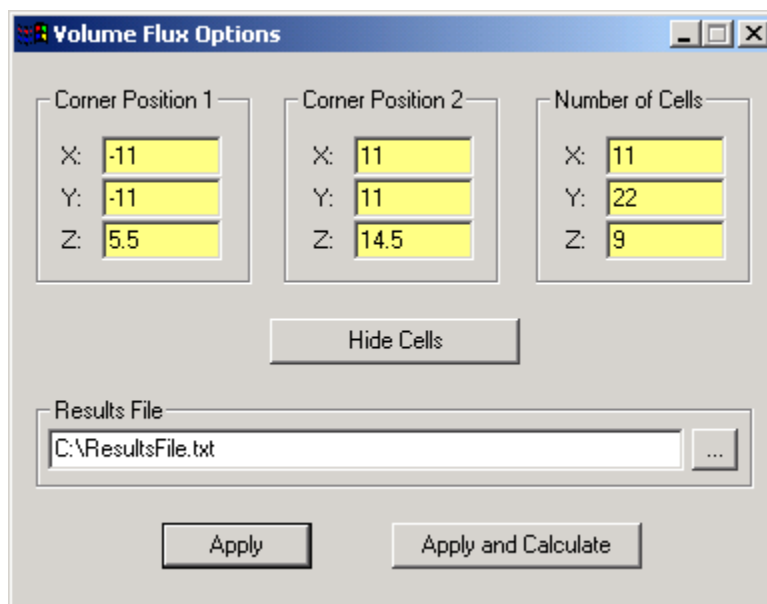

FIGURE 6.46 - Example Volume Flux Options dialog box

The set of cells is described by two corner positions. For each dimension, X, Y, and Z, the value for corner position 2 must be larger than that for corner position 1. The user also specifies the number of cells in each dimension. Finally, the name of the results file is entered. The Show Cells button displays the collection of cells in the model window as shown in Figure 6.47.

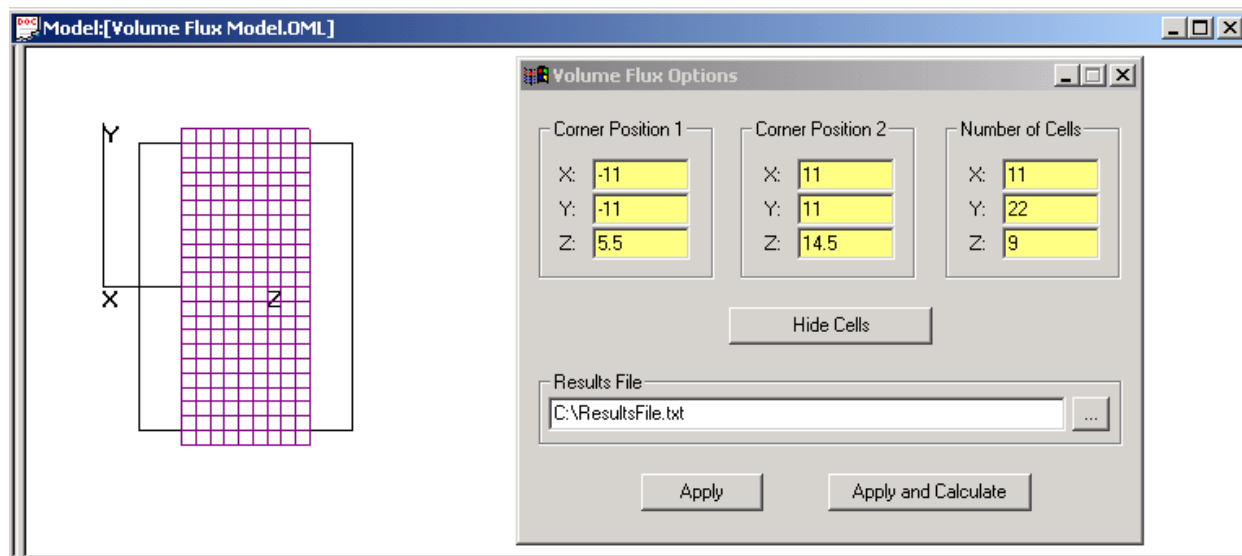

FIGURE 6.47 - TracePro model window showing cells defined for volume flux analysis. This example shows the cells placed inside a sub section of a simple block geometry. The Show Cells button toggles to Hide Cells after being chosen.

For any given raytrace, you can perform volume flux calculations numerous times. By changing the inputs to the *Volume Flux Options* window, you can write the results of volume flux calculations to different files. If desired, each of these calculations can utilize a different volume flux cell configuration; cell positions, number of cells, without having to repeat the raytrace. The data is uses the Volume Flux Viewer to display the results from each file generated. See “View Volume Flux” on page 6.68.

You can also write the results of different raytraces to the same file. This occurs when the volume flux cell configuration does not change from one Apply and Calculate selection to the next. In this case, the results from the current raytrace are mathematically added to the results currently in the file. An incremental counter, which keeps track of the number of simulations is also stored in the file.

A summary of what TracePro will do under different conditions is shown in Table 6.10. For instance, if the specified Results File doesn't exist, a new one is always created. If the Results File does exist, then TracePro compares the data in the file to the current state of the model and the current volume flux cell configuration.

TABLE 6.10 - Summary of TracePro action depending on the current state of the model. The “New” and “Old” labels signify whether changes were made since the last time a volume flux calculation was performed.

Volume Flux Cell Configuration	<i>New</i>	<i>New</i>	<i>Old</i>	<i>Old</i>
Raytrace	<i>New</i>	<i>Old</i>	<i>New</i>	<i>Old</i>
TracePro Action	User is prompted to overwrite Results File	User is prompted to overwrite Results File	New data is added to existing Results File	User is prompted whether existing data should be added to existing data in Results File

View Volume Flux

Overview

The *Volume Flux Viewer*, as shown in Figure 6.46, can be used to visualize data that has been gathered by using the **Collect Volume Flux** option from the **Tools** menu. When volume flux data is collected, it is saved to a text file, which can be loaded into the *Volume Flux Viewer*. Since the volume flux data is arranged in a 3-dimensional grid of data, the volume flux viewer allows you to view any 2-dimensional slice of that data.

To use the *Volume Flux Viewer*, select **Tools | View Volume Flux**. Click the *Open* button to open a Volume Flux file.

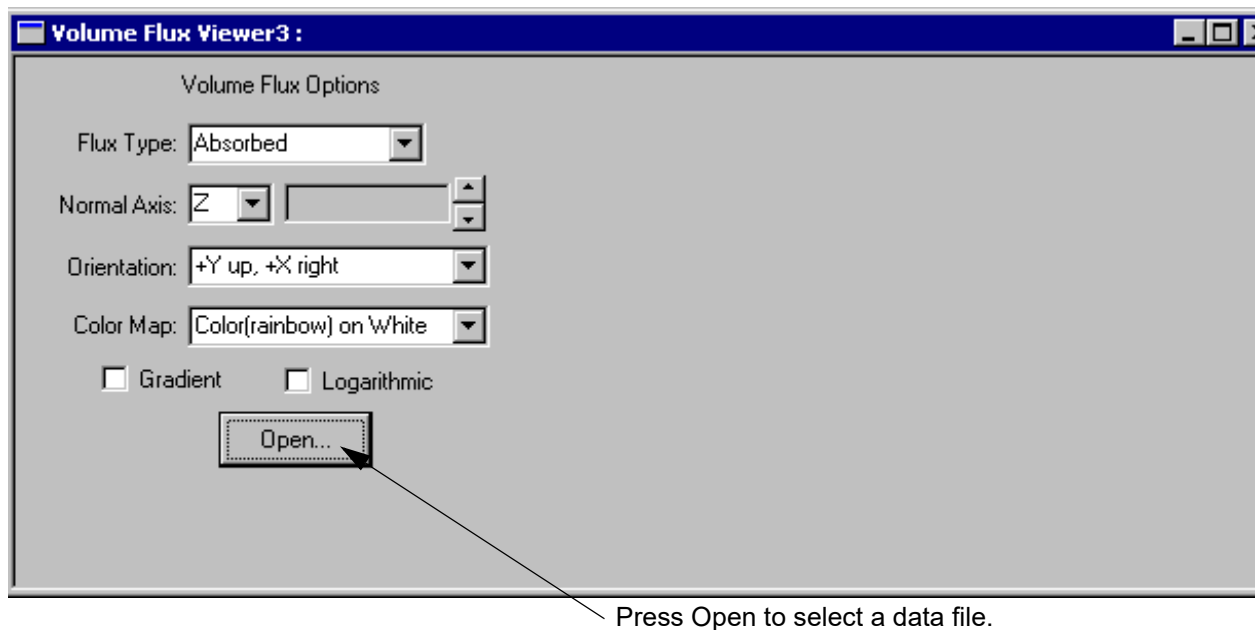

FIGURE 6.48 - New viewer without data file.

Flux Type

Once the volume flux file has been opened, you can change which Flux Type you are viewing by selecting Absorbed, Incident, Lost, or Originating from the Flux Type drop-down list. An example showing an Incident Flux Type is shown in Figure 6.49.

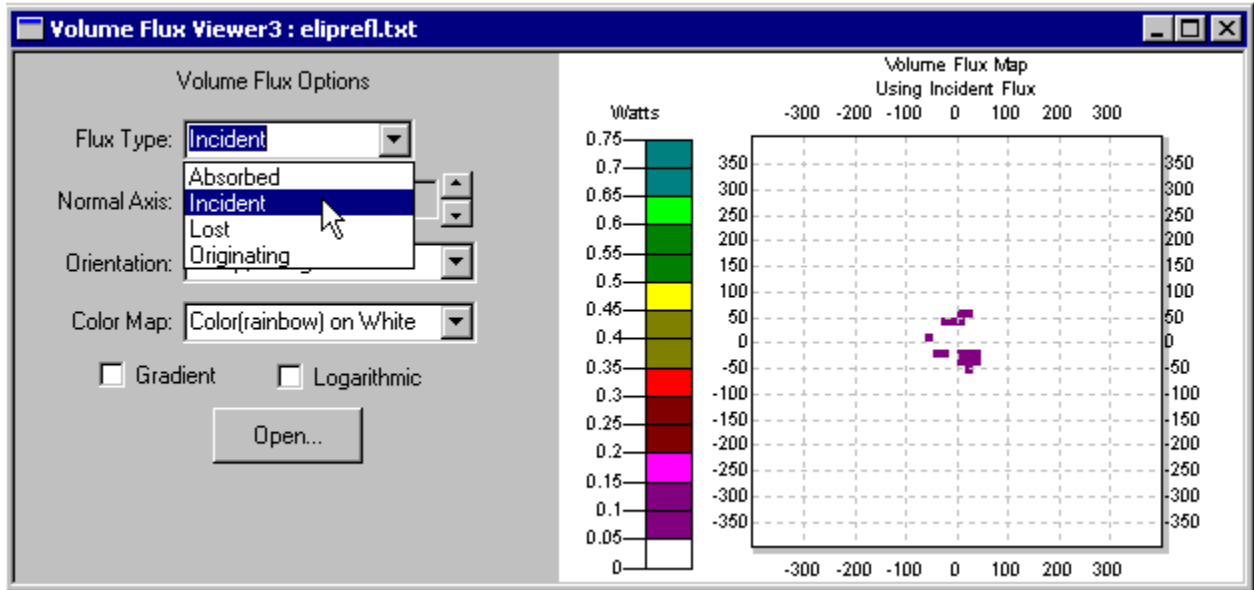

FIGURE 6.49 - Changing the flux type.

Normal Axis/Orientation

The default is to look at the volume flux data with the positive Z axis pointing into the screen (Normal Axis) and the positive Y axis pointing up and the positive X axis pointing right. If, for example, as shown in Figure 6.50, you want to look at the data with the X axis normal to the screen, and the positive Z axis pointing up and the positive Y axis pointing to the left, then you would select the X axis as the Normal Axis, and choose “+Z up, +Y left” from the Orientation drop-down list.

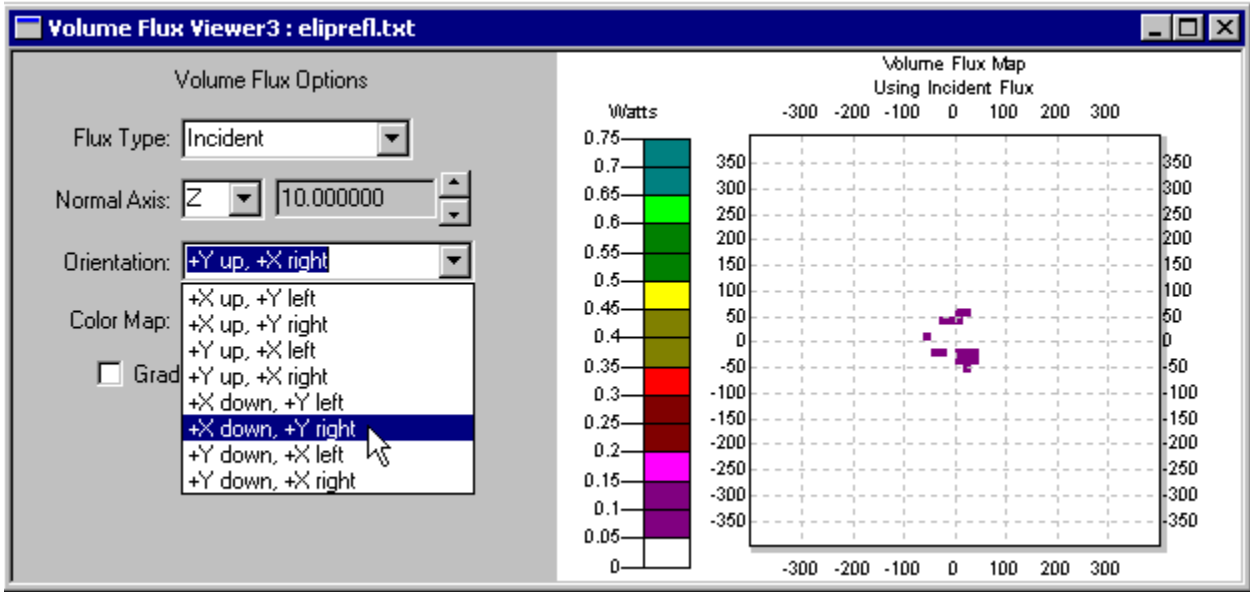

FIGURE 6.50 - Changing the orientation.

Slices

In this example, there are 50 cells along the x-axis. This means that in the above orientation, there are 50 “Slices” of the data that can be displayed. To scroll through the slices, use the spin control (Figure 6.51) to the right of the Normal Axis control. The number just to the left of the spin control shows the axis coordinate (in this case X) of the current slice of data.



FIGURE 6.51 - Spin control for Volume Flux Slices

Color Map

There are several color schemes available for displaying the data. Each can be selected directly from the Color Map drop-down list.

Gradient

By default, the full range of the data is broken in to several ranges, and one assigned to each color in the color map. The color palette on the left shows which color corresponds to which range of data values. The gradient option creates a continuous band of color for the color palette, and each data value in the map is colored based on its position in the color gradient.

Logarithmic

This option will display the data on a logarithmic scale.

Simulation File Manager

The Simulation File Manager, as shown in Figure 6.52, is opened from the **Tools** menu and used to select ray files saved during a Simulation Mode raytrace for viewing in the Irradiance Viewer described below. This requires that you select *Save data to disk during raytrace* in **Raytrace|Raytrace Options|Simulation & Output** before starting the Simulation Mode ray-trace. See “Save Data to Disk during Raytrace” on page 5.48. TracePro collects sets of simulation data with an Index file (.NDX) that holds information about the Model traced and notes for each particular raytrace. The Simulation File Manager is used to read an index file to select the desired data file to view, or Delete when the data is no longer needed. Delete will remove the entry in the index file and delete the *.sim file.

Exit Surface files

The Index file includes links to Exit Surface and Missed Rays Candela Data files. An Exit Surface files contains data needed to view an Irradiance/Illuminance Map or Incident Ray Candela Plot. The name of an Exit Surface file ends with exN, where N is the exit surface number, i.e. ex1 is the first exit surface tabulated by TracePro. To view an Irradiance/Illuminance Map or a Candela Plot using Incident Rays, first select the Exit Surface .sim file you wish to view, then choose the type of plot from the View list at the bottom of the dialog box. Options for the plot are available by right-clicking on the plot and selecting Options from the pop-up menu. See “Irradiance Map Options” on page 6.8 and “Candela Options” on page 6.27

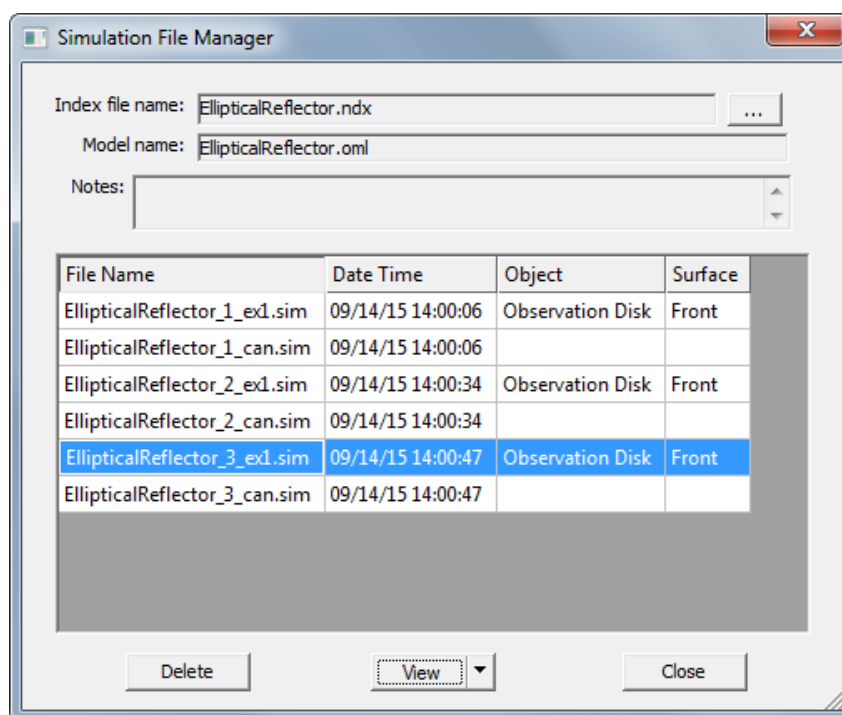

FIGURE 6.52 - Simulation File Manager.

Candela “Missed Rays” Files

TracePro can also save candela data for missed rays, if the checkbox for *Collect Missed Rays Candela Data* in **Raytrace|Raytrace Options|Simulation &**

Output was selected before tracing rays. A Candela file name ends in “can” as shown in Figure 6.52. To display a Missed Rays Candela Plot, choose the appropriate “can” file, click View, and select the type of plot you wish to display. Options for the plot are available by right-clicking on the plot and selecting Options from the pop-up menu. See “Candela Options” on page 6.27.

Irradiance/Illuminance Viewer

Overview

TracePro has the capability to view Irradiance/Illuminance Maps that have been previously saved as text files, and also to add or subtract data from multiple Irradiance/Illuminance Maps. This could be used, for example, to analyze the light distribution from an LED Array, where it is desirable to assess the contribution of each individual LED, and then to see the result of all the LEDs combined.

Viewing a saved Irradiance/Illuminance Map

From the **Tools** Menu, select **Irradiance/Illuminance Viewer**, and select **View** to display a previously saved Irradiance/Illuminance Map. Two types of files may be opened, Text (.TXT) files and Simulation (.SIM) files. To create these files see “Access to Irradiance Data” on page 6.15 and “Save Data to Disk during Raytrace” on page 5.48 respectively.

Irradiance/Illuminance Viewer Options

The Irradiance/Illuminance Viewer Options are available by right-clicking on the Irradiance/Illuminance Viewer window.

TXT Data Files

For Text (.TXT) files the options available in the Irradiance/Illuminance Viewer are a subset of those available for an Irradiance Map. Some of the options are disabled but show the value used when the data was saved to disk.

The available options include:

- Set Max
- Set Min
- Gradient Display
- Convert to foot-candles
- Log Scale
- Relief Plot
- Profiles
- Color Map

For a description of the options see “Irradiance Maps” on page 6.7.

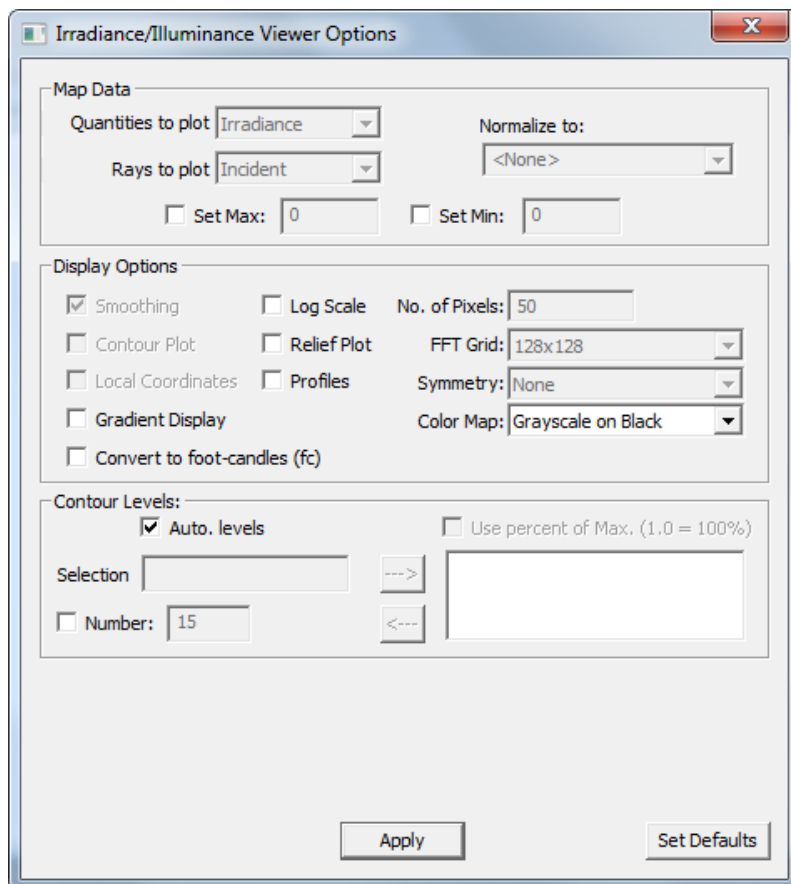

FIGURE 6.53 - Options dialog for Irradiance Viewer, TXT files.

SIM Data Files

For Simulation Files all of the options excluding selection of the Normal and Up Vectors are supported. The Normal and Up Vectors must be defined when the Exit Surface property is applied. See “Predefined irradiance map orientation” on page 4.31.

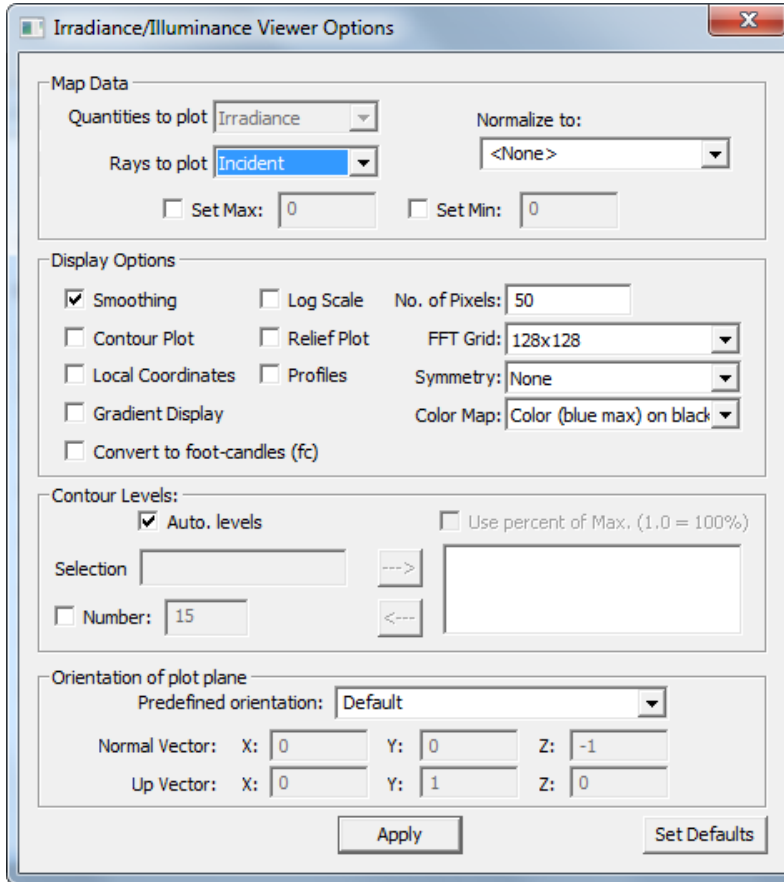

FIGURE 6.54 - Options dialog for Irradiance Viewer, SIM files.

Adding and Subtracting Irradiance/Illuminance Maps

After an Irradiance/Illuminance Map has been opened in the Irradiance/Illuminance Viewer, the Add and Subtract options are available from the Tools menu. These options allow the user to combine data from additional maps, thus being able to view the combined data. Note that after adding and subtracting maps, the filename displayed in the Title Bar of the Irradiance/Illuminance Viewer is the name of the first file that was viewed.

Note: Only Text (.TXT) files may use the add/subtract functions.

When adding and subtracting Irradiance/Illuminance Maps, it is important to understand the effects of the following parameters on the Irradiance/Illuminance Map text file:

- Smoothing ON or OFF
- Map Count
- Resolution
- Dimensions (linear dimensions of map)

As shown in Figure 6.55 below, the Irradiance/Illuminance Map text files start with a fixed number of rows for header information, followed by an array or grid of Irradiance/Illuminance values

The Irradiance/Illuminance Viewer can only add two files with the same Grid Size. For an unsmoothed map, the Grid Size is equal to the *No. of Pixels*. For a smoothed map, the Grid Size is equal to the FFT Grid. TracePro will combine the data provided the Grid Size of the two maps is the same, but there are two instances where TracePro will provide a warning to verify that this addition/subtraction is intended. One instance is if the linear dimensions of the two maps are different (e.g. – one map is the data for a 1-mm x 1-mm Exit Surface while the other map is the data for a 2-mm x 2-mm Exit Surface). The second instance is for smoothed maps where the *No. of Pixels* is different. For a smoothed map, the *No. of Pixels* parameter alters the “degree of smoothing”, so it may not be desirable to add or subtract two maps with different smoothing characteristics. In the case where smoothing is desired, it is best to save the unsmoothed data, then combine them in the viewer whereupon smoothing can be added.

```
TracePro Release: 7 7 0
Irradiance Map Data for D:\TraceProData\EllipticalReflector.oml

Linear Units in millimeters
Data for Observation Disk Front
Data generated at 08:32:44 September 14, 2015

Raytrace Time: mins: 0, secs: 9

Projected Plane Extent from surface geometry
  TopLeft:(300,300,1000)
  TopRight:(-300,300,1000)
  BottomLeft:(300,-300,1000)
  BottomRight:(-300,-300,1000)
Corners of Data Set (plotted)
  TopLeft:(300,300,1000)
  TopRight:(-300,300,1000)
  BottomLeft:(300,-300,1000)
  BottomRight:(-300,-300,1000)
Total Incident Rays: 109966
Min: 4.96551e-012 Max: 1018.73 Ave: 25.8429
Total Flux: 7.30692 lm, Emitted Flux: 10 lm
Data Smoothing is On
Grid Size is 128 x 128
Map Count 50
Data Cells are 4.6875 x 4.6875 millimeters

6.74368e-009 5.85357e-009 6.14844e-009 8.58517e-009 6.04197e-009 5.58483e-009 .....
1.26708e-008 1.42955e-008 1.44828e-008 1.28075e-008 1.59571e-008 1.73264e-008 .....
1.22095e-008 2.14864e-008 2.25737e-008 2.53281e-008 2.35472e-008 2.33365e-008 .....
```

FIGURE 6.55 - Header section of a saved Irradiance/Illuminance Map with initial data rows shown.

Candela Plot Viewer

The Candela Plot Viewer enables you to open candela output saved as a text file and re-display the plot, or open a previously-saved *.sim file and make a new Candela Plot.

Viewing a saved Candela Plot by opening a *.txt file

To open a saved Candela Plot, select **Tools|Candela Plot Viewer**, and an *Open* dialog box will open. Select *Files of type: *.txt*, browse to the Candela file you wish to view, and click *Open*. To control the options for the plot, right-click on the plot and select **Candela Options**. The options that are available are a subset of those available in the in-session Candela Options dialog box.

Viewing a Candela Plot by opening a *.sim file

By opening a *.sim file from a previous *Simulation Mode* ray-trace (with **Raytrace|Raytrace Options|Simulation & Output Save data to disk during raytrace** enabled) you can create a new Candela Plot with access to most of the Candela Options settings that are used in a live session. The plot types available depend on the file type opened as shown in Table 6.11.

TABLE 6.11. Candela plots available by opening *.sim files.

File type for raytrace no. N, Exit Surface no. M	Candela plot available
Exit surface file (<i>ModelName_N_exM.sim</i>)	Rays incident on Exit Surface
Candela Missed Rays file (<i>ModelName_N_can.sim</i>)	Missed Rays

To open a *.sim file for creating a new Candela Plot, select **Tools|Candela Plot Viewer**, and an *Open* dialog box will open. Select *Files of type: *.sim*, browse to the file you wish to view, and click *Open*.

Analysis Toolkit

The Analysis Toolkit gives you access to enhanced plots of Candela Polar data, including:

- Spectrum analysis
- Irradiance/Illuminance Map
- Road Luminance
- Candela - Rectangular Chart
- Candela - 360 degree Polar Chart
- Candela - 180 degree Polar Chart II
- Candela - Circular Polar Chart
- Candela - Circular Polar Chart II
- Beam Illuminance
- RCG Analysis
- LCS Analysis
- DHI Analysis

Open the *Analysis Toolkit* by selecting **Tools|Analysis Toolkit** or by right-clicking on a Candela Plot and selecting *Analysis Toolkit*. To start an analysis tool, double-click on the tool in the Analysis Toolkit window. Access options for each plot by right-clicking on the plot.

The Analysis Toolkit has its own help system.

Solar Emulator

The *Solar Emulator* is a fully automated interactive solar analysis utility. The solar utility enables you to analyze solar collector systems by defining the geographical location, period of sun travel, and solar power emission to simulate cloudy to clear day calculations. Complete diagnostic output is available including irradiance and candela maps on target surfaces, total flux on the target per time period, and tabular output detailing efficiency over time. Use dialog boxes to setup sun position, use Google Earth for location verification, verify trajectory using 3D earth modeling, and qualify output analysis using dialog boxes. Once the emulator is set up, it will perform ray-traces using TracePro to generate the needed data.

To start the Solar Emulator, select **Tool s | Sol ar Emul ator**.

The Solar Emulator has its own context-sensitive help system.

IES/LDT Plots

TracePro's *IES/LDT Plots* feature enables you to import photometric data in ANSI/IESNA standard electronic file format or Eulumdat format to create TracePro Surface Source and File Source Properties, and analyze the data. The Illuminating Engineering Society of North America (IESNA) publishes "IESNA Standard File Format for the Electronic Transfer of Photometric Data and Related Information." The TracePro IES/LDT Import Utility adheres to IESNA Standard LM-63-02, approved by ANSI on September 12, 2002. For more information on the Eulumdat format, see www.helios32.com/Eulumdat.htm.

To use the IES/LDT Plots tool, select **Tool s | I ES/LDT Pl ots**.

The IES/LDT Plots tool has its own help system.

Lighting Toolkit Standard Expert

TracePro's *Lighting Toolkit* enables you to compare candela output to various lighting standards. You can analyze your design's compliance with ECE, SAE, and FMVSS standards. The toolkit provides visualization tools and regulation tables to certify that simulated results meet the various standards and provides pass/fail criteria for each regulation.

To open the Lighting Toolkit, select **Tool s | LI ghtI ng Tool kl t**.

The Lighting Toolkit has its own help system

Stray Light Analyzer Standard Expert

TracePro's *Stray Light Analyzer* provides a graphical user interface to set up the iterative raytrace, analysis plots, and accurate sources required for stray light analysis, making the process smooth and easy.

To open the Lighting Toolkit, select **Tool s | Stray LI ght Anal yzer**.

The Stray Light Analyzer has its own help system

Measurement Dialog

TracePro provides a tool to display information for different entity types in the Model along with the relationship between two entities. The entities that can be used are Surface, Edge and Vertex. The dialog, shown in Figure 6.56, provides a selection of the Measurement Type based on the combination of entities to be measured. The combinations may be:

- **Vertex - Vertex**
- **Vertex - Edge**
- **Vertex - Surface**
- **Edge - Edge**
- **Edge - Surface**
- **Surface - Surface**

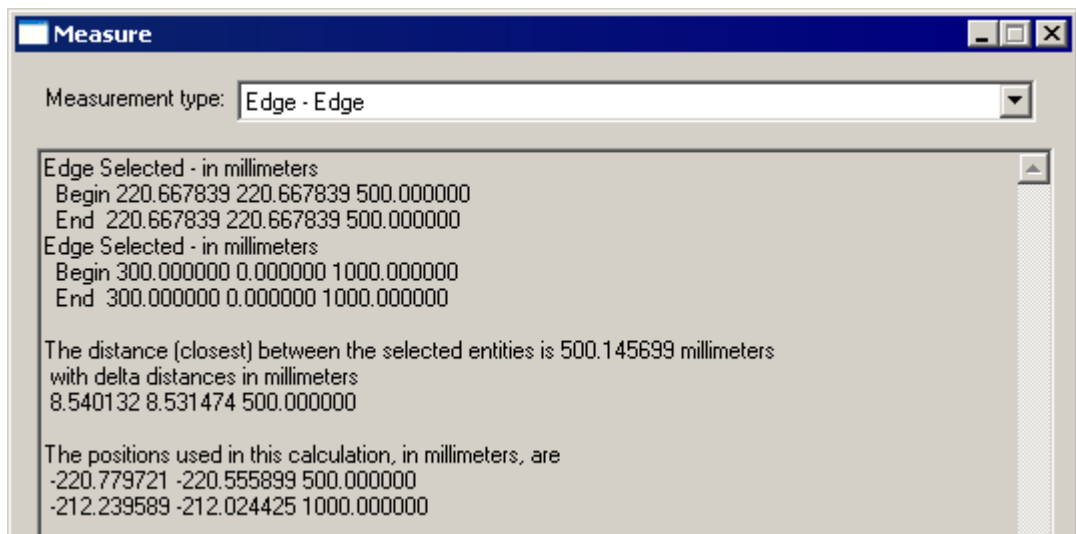

FIGURE 6.56 - Measurement Dialog showing edge information and distance between two selected edges

After the Measurement type is selected, TracePro will prompt for two selections. After each selection information pertinent to the entity type is displayed. The relationship between the two entities is displayed after the second item is selected. The relationship is the closest distance between the two entities, the transverse or delta distances between the entities, and the positions upon the two entities from which the distances are calculated. The information is displayed in Model Units and angles are displayed in degrees.

The Cursor will change to indicate the type of selection required.:



-  Vertex Selection Cursor
-  Edge Selection Cursor
-  Surface Selection Cursor

Figure 6.57 shows a model with an Edge-Edge measurement after the two edges have been selected. The Cursor shows that an edge can be selected to continue the next measurement.

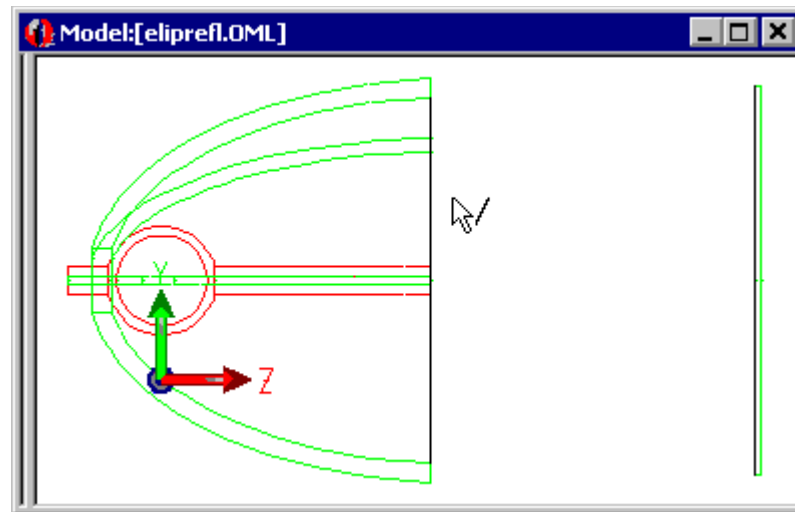

FIGURE 6.57 - Elliptical Reflector with two edges selected for measurement

Figure 6.56 shows the result of the measurement. When an edge is selected its starting and ending positions are displayed in Model Units. The position is displayed for a vertex. The distance is given as the minimum distance between the two selections.

Introduction

This chapter contains detailed information for many aspects of TracePro. Similar topics appear in prior chapters giving general details and have referenced this chapter for in depth coverage. Generally you can refer to the topics in this chapter as needed.

The Use of Ray Splitting in Monte Carlo Simulation

Monte Carlo simulation is a field unto itself and is used to simulate many different types of physical processes. Whenever processes are treated stochastically, with samples chosen randomly and probability distributions used to model physical processes, it is called Monte Carlo. In optics, the rays are the samples and specular reflection and transmission, reflective and transmissive scattering, and absorption are the processes. The Monte Carlo technique originates in the Manhattan project during World War II, where it was used to simulate neutron transport in fissionable material. The first computer on which Monte Carlo simulations were done was a room full of people with calculators at Los Alamos, supervised by the scientists there. Later at Los Alamos, the first electronic computer was used to do Monte Carlo simulation. After the war and into the 1950s, Monte Carlo techniques were enhanced with variance reduction techniques to vastly improve the speed of convergence of Monte Carlo simulations. The most successful of these are splitting, importance sampling, and stratified sampling. These techniques are still in widespread use today.

In the late 1950s and early 1960s, Monte Carlo was first used to trace rays, not for optical simulations, but for simulation of radiative heat transfer. On those early computers with limited processing power, they implemented what was called “crude Monte Carlo” or Monte Carlo without any variance reduction. In the late 1960s, the first optical Monte Carlo program was developed: GUERAP. It used both splitting and importance sampling for variance reduction. TracePro embodies the same variance reduction techniques as GUERAP.

Also in the late 1960s, the first workers in computer graphics were making pictures on line printers using crude Monte Carlo, which they dubbed “photon tracing.” In crude Monte Carlo, a ray would retain all of its flux, and be either fully absorbed or fully transmitted. Crude Monte Carlo does in fact conserve energy, but also suffers from slow convergence, i.e. large variance for a given sample population.

Ray Splitting as applied to ray tracing means that rays are split into different components, each carrying a fraction of the incident flux. For each ray incident on a surface, with Ray Splitting ON and 1 Random Ray per scatter selected, TracePro creates up to four rays (specular R and T, scattered R and T) leaving the surface. The sum of the flux of the four rays is equal to the flux of the incident ray less any absorption at the surface (absorption can be considered as a fifth split ray that doesn't propagate).

The truth of the matter is that, except in rare cases, the use of variance reduction (including ray splitting) does reduce the variance, and sometimes in very dramatic

fashion. In stray light problems, the improvement in convergence may be a factor of $1e10$ to $1e20$. These problems are completely hopeless without variance reduction.

The ability to turn Ray Splitting OFF was implemented for those rare cases in which even simple ray splitting results in a bushy “ray tree” and prodigious memory usage. With Ray Splitting OFF, TracePro uses the Surface Property components (specular R and T, scattered R and T) as the probability of a ray having 1 of those 4 outcomes, and generates one new ray with flux equal to that of the incident ray less any absorption at the surface. Ray Splitting OFF is the nearest thing in TracePro to a crude Monte Carlo raytrace. However, in TracePro with Ray Splitting OFF, a portion of the flux of each ray is absorbed, so each ray may decrease in flux as it propagates. This variation from Crude Monte Carlo was implemented because it reduces the variance without any extra memory usage.

In summary, it is recommended that Ray Splitting be left ON, that raytrace time be controlled through the Flux Threshold and the number of starting rays, and that the convergence be monitored by reviewing the Lost Flux column of the Flux Report. The Ray Splitting OFF option is reserved only for those cases when good results cannot be obtained with ray splitting on.

Importance Sampling Standard Expert

Importance sampling is a Monte Carlo technique in which rays are generated and propagated in specific directions in the optical system, which are “important” in determining the results you need. This improves sampling by increasing the number of rays reaching the surface or surfaces of interest to the user.

Importance sampling is essential in a stray light analysis, where the attenuation of incident light can be very great, and can be helpful in other types of analyses. In a stray light analysis, there should be an importance sampling target for each optical surface in the optical system.

It is important to remember that importance sampling is used only to enhance the sampling of *scattered and diffracted light* or *surface sources*. Designs that include only specular reflection and transmission cannot take advantage of importance sampling — the direction of the rays is determined by the Law of Reflection and Snell’s Law.

Figure 7.1 on page 7.3 illustrates importance sampling for the simple case of a lens that scatters from its second surface. A second object is shown that corresponds to a detector. In this case rays from an off-axis field position are imaged such that all of the specular rays miss the detector. Generally, scattering is stronger close to the specular direction of the un-scattered ray so the probability of a randomly scattered ray hitting the detector is very small. When an importance target is applied, it guarantees that the one or more importance rays will hit the detector for each incident ray. Since the flux in the importance ray is scaled by the solid angle and the scattering distribution, a “real” answer is simulated with the fewest actual rays traced.

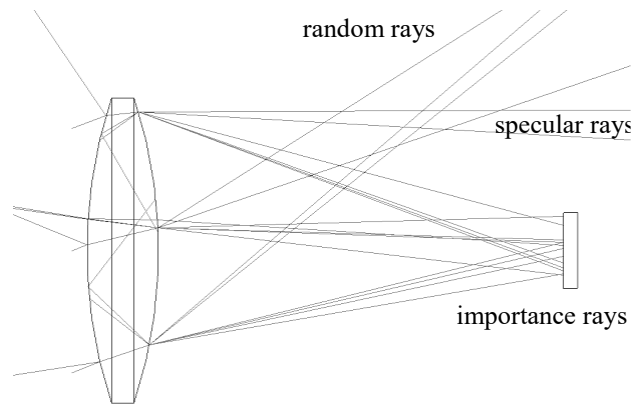

FIGURE 7.1 - Lens shows specular, scatter, and importance rays

Importance Sampling and Random Rays

In the absence of importance sampling, TracePro generates rays in random directions to simulate scattering. If you are simulating a problem in which light is greatly attenuated, for example, stray light analysis, very little light or even none at all reaches the surface you are concerned about. For example, if you are trying to determine the likelihood of stray light reaching the detector from a source far outside the field of view of an optical system with good stray light attenuation, you might have to trace a very large number of rays (10^{10} , 10^{20} or more) to get even one ray to strike the detector. Importance sampling provides a way of increasing the rate of occurrence in the simulation of physically unlikely events, while still getting the right answer in the end. Importance sampling increases the probability of events occurring that are *important to you*.

Importance sampling affects the tracing of scattered and diffracted rays. When a ray strikes a surface with scattering and with importance sampling, the scattered split ray component is further split into a randomly scattered component and an importance sampled component. The direction of the importance sampled component is determined by aiming the ray at an *importance sampling target*. In principle, the flux given to the ray component is determined by calculating the integral of the BSDF over the solid angle subtended by the importance sampling target as seen from the intersection point on the scattering surface, and multiplying by the incident flux,

$$\Phi_{\text{important}} = \Phi_{\text{incident}} \int_{\Delta\Omega} \text{BSDF}(\Omega) \cos\theta d\Omega. \quad (7.1)$$

In practice, the integral is approximated by evaluating the BSDF at the ray direction and multiplying by the solid angle subtended by the target,

$$\Phi_{\text{important}} \approx \Phi_{\text{incident}} \cdot \text{BSDF}\Omega \cdot \cos\theta \cdot \Delta\Omega. \quad (7.2)$$

This approximation means that the flux of some importance-sampled rays is underestimated and others are overestimated. To yield the correct result, it is necessary to average the flux of a large number of rays. The flux of the

importance-sampled ray is subtracted from the total allocated for scattering. The remainder of the flux is given to the randomly-scattered component. The direction of the random component is chosen randomly, weighted by the BSDF. TracePro checks the direction of the ray to be sure that it does not intersect the importance sampling target. If it does intersect the importance sampling target, another random direction is chosen and the check performed again. This process repeats until a valid ray direction is found or until a specified threshold is exceeded. If the threshold is exceeded, the random ray component is discarded.

When Do I Need Importance Sampling?

Use importance sampling for:

1. Stray light analysis
2. A non-imaging analysis involving scattering, especially when the collecting area is relatively small
3. A surface source, when you want a large number of rays to be sampled in a particular narrow direction

A good way to decide whether or not to use importance sampling is the following: you usually want to have good sampling at the source and at the exit surface. The fineness of sampling (the number of rays) you need over the source and the exit surface depends on the specific simulation you are doing. In some cases, the source is well-represented by only a few rays (tens or hundreds); in other cases, many rays (thousands or millions) can be required.

The same is true for the exit surface. You directly control the sampling at the source by choosing the number of starting rays and the type of ray distribution. You indirectly control the number of rays at the exit surface for each starting ray by using importance sampling. The more rays you start, the longer the simulation takes to complete. Use of importance sampling increases the exit sampling and the execution time as well, but produces many more samples at the surface of interest. Proper use of importance sampling lets you get sampling at the surface of interest with far fewer starting rays.

If the goal of your simulation is to predict the irradiance with fine spatial resolution, you need a great many rays at the exit surface. You find that, due to the statistical nature of the Monte Carlo technique, the irradiance distribution is noisy, just as in a measurement of light with insufficient source intensity or insufficient integration time. To improve the signal-to-noise ratio, you need to get more ray components to the exit surface, just as in a measurement you might use a stronger source and/or a longer integration time. You can get more ray components by starting more rays and/or by increasing the importance sampling.

How to Choose Importance Sampling Targets

The objective of importance sampling is to increase the probability of rays going along paths that are important to you. A rule of thumb is to obtain a probability of 1 (certainty) of a ray component reaching the surface of interest for each ray started. For stray light analysis of optical systems with good stray light suppression capabilities, this is a challenge. The optimal selection of importance sampling is a matter of judgment, but several guidelines are given below. At a minimum, however, importance sampling has to be defined for every optical surface in a system when doing a stray light analysis.

Importance Sampling Example

First, consider what happens if there is no importance sampling. Rays are scattered and diffracted at each surface using the BSDF of that surface as a probability distribution for ray directions. What if a ray enters an optical system, strikes a sunshade as shown below, and the sunshade is coated with flat black (Lambertian) paint?

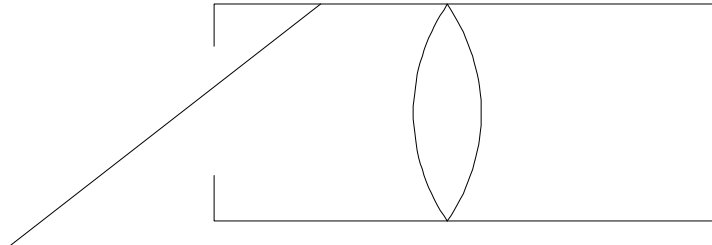

FIGURE 7.2 - No Importance Sampling

A ray component randomly scattered from this surface has a distribution probability equal to:

$$\frac{dP}{d\Omega} = \frac{\cos\theta}{\pi}. \quad (7.3)$$

The probability of a ray going toward the lens is the integral of the probability density over the solid angle subtended by the lens as viewed from the ray intersection point on the sunshade. Suppose the lens has a radius $R_{\text{lens}} = 1$ and the ray strikes the sunshade a distance $d = 2$ away from the lens and leaves the sunshade at an angle of 60 degrees. Then the probability of the ray striking the lens is approximately:

$$p_1 = \frac{\cos\theta}{\pi} \cdot \frac{\pi R_{\text{lens}}^2}{d^2} = \frac{1}{8}. \quad (7.4)$$

Now suppose the lens has a typical BSDF for a polished surface, that is, sharply peaked in the specular direction. For example, let the BSDF for the direction of scattering toward the detector be:

$$f_s \approx 3 \times 10^{-7} / \sin^2\theta. \quad (7.5)$$

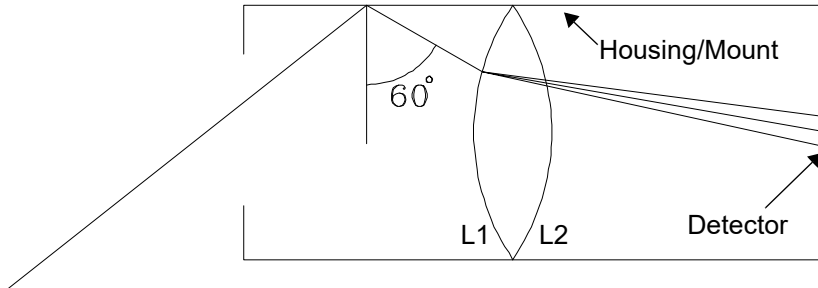

FIGURE 7.3 - Scatter

To compute the probability of a ray that hits the lens, then scatters in a direction such that it strikes an on-axis detector which is 1 milliradian on a side, as shown in Figure 7.3. As before, the probability is approximately:

$$p = f_s(\theta) \cos \theta \Delta \Omega , \tag{7.6}$$

where: $\Delta \Omega = (10^{-3} \text{ radian})^2$, and suppose $\theta = 30$ degrees.

Evaluating the probability, we get:

$$p_2 = 1.04 \times 10^{-12} . \tag{7.7}$$

The probability of a ray scattering from the sunshade directly to the lens and then directly to the detector is the product of those probabilities:

$$p_{\text{total}} = p_1 p_2 = 1.30 \times 10^{-13} . \tag{7.8}$$

This means that we will have to start about 10^{13} rays to have a good chance of getting one ray to go along a path like the one described. The most obvious way to improve our chances is to set up importance sampling from the lens to the detector. That increases p_2 to 1, resulting in a much more tolerable situation:

$$p_{\text{total}} = p_1 = \frac{1}{8} . \tag{7.9}$$

The detector surface cannot be defined as an importance sampling target for the lens surface, as can be seen in Scatter, Figure 7.3. We need to set up importance sampling toward the image formed by the lens surface, rather than the image formed by the system. For surface L2, however, we set up importance sampling directly to the detector.

Importance sampling targets must be located at the image formed by the optical surface. In this way, any ray that strikes any optical surface always produces a ray that hits the detector.

Material Properties

In TracePro, a material property specifies an index of refraction and a coefficient of bulk absorption. In the Apply Properties dialog box, the Material tab lets you choose a material property from the TracePro Property Database and apply it to an object in a model.

Material Property Database

Data can be added or modified in the property database by using the Material Property Editor. This editor is on the **Define|Edit Properties/Material Properties** menu.

The Material Property Editor can modify the interpolation type, description, temperature and interpolation coefficients or table entries. A spreadsheet-like window displays coefficients of interpolation formulae or wavelengths and index values for tabular data. Absorption data is entered in units of inverse millimeters (1/mm).

Selecting a catalog and entering a material name causes TracePro to display the data for that material. Pressing Add Material Property opens a dialog box where you enter the name of the new material.

Material Property Interpolation

The following interpolation formulas are available for material property data. The a_i values are displayed above the spreadsheet part of the window.

Schott:

$$N^2(\lambda) = a_1 + a_2\lambda^2 + \frac{a_3}{\lambda^2} + \frac{a_4}{\lambda^4} + \frac{a_5}{\lambda^6} + \frac{a_6}{\lambda^8} \quad (7.10)$$

Sellmeier 1:

$$N^2(\lambda) - 1 = \frac{a_1\lambda^2}{\lambda^2 - a_4} + \frac{a_2\lambda^2}{\lambda^2 - a_5} + \frac{a_3\lambda^2}{\lambda^2 - a_6} \quad (7.11)$$

Extended Schott:

$$N^2(\lambda) = a_1\lambda^8 + a_2\lambda^6 + a_3\lambda^4 + a_4\lambda^2 + a_5 + \frac{a_6}{\lambda^2} + \frac{a_7}{\lambda^4} + \frac{a_8}{\lambda^6} + \frac{a_9}{\lambda^8} + \frac{a_{10}}{\lambda^{10}} \quad (7.12)$$

Herzberger:

$$N(\lambda) = a_1 + a_2L + a_3L^2 + a_4\lambda^2 + a_5\lambda^4 + a_6\lambda^6 \quad (7.13)$$

$$L = \frac{1}{\lambda^2 - 0.028}$$

Conrady:

$$N(\lambda) = a_1 + \frac{a_2}{\lambda} + \frac{a_3}{\lambda^{3.5}} \quad (7.14)$$

Sellmeier 2:

$$N^2(\lambda) - 1 = a_1 + \frac{a_2\lambda^2}{\lambda^2 - a_4} + \frac{a_3}{\lambda^2 - a_5} \quad (7.15)$$

Sellmeier 3:

$$N^2(\lambda) - 1 = \frac{a_1\lambda^2}{\lambda^2 - a_5} + \frac{a_2\lambda^2}{\lambda^2 - a_6} + \frac{a_3\lambda^2}{\lambda^2 - a_7} + \frac{a_4\lambda^2}{\lambda^2 - a_8} \quad (7.16)$$

Sellmeier 4:

$$N^2(\lambda) = a_1 + \frac{a_2\lambda^2}{\lambda^2 - a_4} + \frac{a_3\lambda^2}{\lambda^2 - a_5} \quad (7.17)$$

Handbook of Optics 1:

$$N^2(\lambda) = a_1 + \frac{a_2}{\lambda^2 - a_3} - a_4\lambda^2 \quad (7.18)$$

Handbook of Optics 2:

$$N^2(\lambda) = a_1 + \frac{a_2\lambda^2}{\lambda^2 - a_3} - a_4\lambda^2 \quad (7.19)$$

Gradient Index Profile Polynomials

The current Gradient Profiles have the following polynomial forms with associated coefficients.

Axial-Radial gradient

$$n(r, z) = n_0 + \mathbf{nz1}z + \mathbf{nz2}z^2 + \mathbf{nz3}z^3 + \mathbf{nz4}z^4 + \mathbf{nr1}r^2 + \mathbf{nr2}r^4 + \mathbf{nr3}r^6 + \mathbf{nr4}r^8$$

$$\text{where... } r^2 = x^2 + y^2$$

Axial-Elliptical gradient

$$n(r, z) = n_0 + \mathbf{nz1}z + \mathbf{nz2}z^2 + \mathbf{nz3}z^3 + \mathbf{nz4}z^4 + \mathbf{nr1}r^2 + \mathbf{nr2}r^4 + \mathbf{nr3}r^6 + \mathbf{nr4}r^8$$

$$\text{where... } r^2 = \mathbf{nrx}x^2 + \mathbf{nry}y^2$$

Axial-Sinusoidal gradient

$$n(r, z) = n_0 + \mathbf{nz1}z + \mathbf{nz2}z^2 + \mathbf{nz3}z^3 + \mathbf{nz4}z^4 + \mathbf{nr1}r^2 + \mathbf{nr2}r^4 + \mathbf{nr3}r^6 + \mathbf{nr4}r^8$$

$$\text{where... } r^2 = \left[1 + \mathbf{sva} \sin\left(\frac{z}{\mathbf{svp}} + \mathbf{svf}\right) \right] (x^2 + y^2)$$

Axial-Tapered gradient

$$n(r, z) = n_0 + \mathbf{nz1}z + \mathbf{nz2}z^2 + \mathbf{nz3}z^3 + \mathbf{nz4}z^4 + \mathbf{nr1}r^2 + \mathbf{nr2}r^4 + \mathbf{nr3}r^6 + \mathbf{nr4}r^8$$

$$\text{where... } r^2 = [1 + (\mathbf{tas}z + \mathbf{tao})](x^2 + y^2)$$

SELFOC gradient

$$n^2(r) = n_0^2 [1 - (\mathbf{nr1}r)^2 + \mathbf{nr2}(\mathbf{nr1}r)^4 + \mathbf{nr3}(\mathbf{nr1}r)^6 + \mathbf{nr4}(\mathbf{nr1}r)^8]$$

$$\text{where... } r^2 = x^2 + y^2$$

Wood Lens gradient

$$n(r) = n_0 + \mathbf{nr1}r^2$$

$$\text{where... } r^2 = x^2 + y^2$$

Spherical gradient

$$n(r) = n_0 + \mathbf{nr1}(\mathbf{sgc} - r) + \mathbf{nr2}(\mathbf{sgc} - r)^2 + \mathbf{nr3}(\mathbf{sgc} - r)^3 + \mathbf{nr4}(\mathbf{sgc} - r)^4$$

$$\text{where... } r^2 = x^2 + y^2 + (z - \mathbf{sgc})^2$$

Fisheye Lens gradient

$$n(r) = \frac{n_0}{1 + \left(\frac{r}{nr1}\right)^2}$$

where... $r^2 = x^2 + y^2 + (z - \mathbf{sgc})^2$

Luneburg Lens gradient

$$n(r) = n \sqrt{2 - \left(\frac{r}{nr1}\right)^2}$$

where... $r^2 = x^2 + y^2 + (z - \mathbf{sgc})^2$

GRADIUM gradient

$$\begin{aligned} n_{\mathbf{g}\mathbf{w}\mathbf{v}}(z') = & \mathbf{gnz0} + \mathbf{gnz1}\left(\frac{z'}{\mathbf{gmz}}\right) + \mathbf{gnz2}\left(\frac{z'}{\mathbf{gmz}}\right)^2 + \mathbf{gnz3}\left(\frac{z'}{\mathbf{gmz}}\right)^3 + \\ & \mathbf{gnz4}\left(\frac{z'}{\mathbf{gmz}}\right)^4 + \mathbf{gnz5}\left(\frac{z'}{\mathbf{gmz}}\right)^5 + \mathbf{gnz6}\left(\frac{z'}{\mathbf{gmz}}\right)^6 + \\ & \mathbf{gnz7}\left(\frac{z'}{\mathbf{gmz}}\right)^7 + \mathbf{gnz8}\left(\frac{z'}{\mathbf{gmz}}\right)^8 + \mathbf{gnz9}\left(\frac{z'}{\mathbf{gmz}}\right)^9 + \\ & \mathbf{gnz10}\left(\frac{z'}{\mathbf{gmz}}\right)^{10} + \mathbf{gnz11}\left(\frac{z'}{\mathbf{gmz}}\right)^{11} \end{aligned}$$

where... $z' = \mathbf{goz} + z$

TracePro supports two formats for GRADIUM: Buchdahl and Sellmeier. Both use the above expression for $n_{\text{gwv}}(z')$ as their index profile. The two GRADIUM versions differ only in their dispersion formulae. The Buchdahl form is older and now obsolete. It is included for backward compatibility. The Sellmeier form is currently used by LightPath Technologies, the manufacturers of GRADIUM glass. Both of these forms are described in detail below.

The GRADIUM (Buchdahl) dispersion is described by 16 coefficients via a fourth-order expansion in Buchdahl's chromatic coordinate ω .

At a wavelength other than **gwv**, the index is computed as follows.

$$n_{\lambda}(z') = n_{\text{gwv}} + V_1\omega + V_2\omega^2 + V_3\omega^3 + V_4\omega^4$$

where...

$$\omega = \frac{\lambda - \text{gwv}}{1 + \frac{\lambda - \text{gwv}}{\text{gwv} - 0.187}}$$

$$V_1 = \text{gra1}n_{\text{gwv}}^3 + \text{grb1}n_{\text{gwv}}^2 + \text{grc1}n_{\text{gwv}} + \text{grd1}$$

$$V_2 = \text{gra2}n_{\text{gwv}}^3 + \text{grb2}n_{\text{gwv}}^2 + \text{grc2}n_{\text{gwv}} + \text{grd2}$$

$$V_3 = \text{gra3}n_{\text{gwv}}^3 + \text{grb3}n_{\text{gwv}}^2 + \text{grc3}n_{\text{gwv}} + \text{grd3}$$

$$V_4 = \text{gra4}n_{\text{gwv}}^3 + \text{grb4}n_{\text{gwv}}^2 + \text{grc4}n_{\text{gwv}} + \text{grd4}$$

The GRADIUM (Sellmeier) dispersion is described by 48 coefficients via a modified Sellmeier model with three resonances.

At a wavelength other than **gwv**, the index is computed as follows.

$$n_{\lambda}^2(z') - n_{\text{gww}}^2(z') = \sum_{i=1}^3 \frac{K_i'(\lambda^2 - \text{gww}^2)}{\lambda^2 - L_i}$$

where...

$$K_i = \sum_{j=1}^8 K_{ij}' \cdot n_{\text{gww}}^{j-1}(z')$$

and

$$L_i = \sum_{j=1}^8 L_{ij}' \cdot n_{\text{gww}}^{j-1}(z')$$

Complex Index of Refraction

In the material property database, TracePro represents the complex index of refraction by

$$\hat{n} = n + ik$$

where k is the extinction coefficient, and

$$k = \frac{\lambda\alpha}{4\pi}.$$

Here λ is the wavelength and α is the absorption coefficient. In the TracePro Material Property Editor you can enter either α or k , and TracePro will calculate the other parameter.

Some textbooks define the complex index of refraction as

$$\hat{n} = n(1 + \kappa)$$

with κ denoted as the extinction coefficient or attenuation index, while still others use

$$\hat{n} = n - ik$$

or

$$\hat{n} = n(1 - i\kappa).$$

Calculating the Fresnel Coefficients, i.e. the relative flux of a reflected or transmitted wave and its polarization state at the interface of two media is a complicated procedure. However, for a wave at normal incidence on an interface between air and a medium with complex refractive index, the calculation of the reflectance is simpler (Born and Wolf, Fifth Edition, §13.2),

$$R = \left| \frac{\hat{n} - 1}{\hat{n} + 1} \right|^2 = \frac{n^2(1 + \kappa^2) + 1 - 2n}{n^2(1 + \kappa^2) + 1 + 2n}$$

where we have used $\kappa = k/n$.

It is important to be aware that k and κ depend on λ while α does not. When interpolating the material property data, n and α are interpolated, and k is calculated from α .

Surface Properties

Surface properties describe reflection, transmission, absorption, and scattering of a surface.

Coincident Surfaces

TracePro models often incorporate geometry with coincident surfaces. This occurs for such systems where two objects have one common side, e.g., a cemented doublet. This section describes the behavior of TracePro with respect to Surface Properties applied to those coincident surfaces. The three cases are:

1. No Surface Property (i.e., <None>) applied to either coincident surface - TracePro will calculate the reflectance and transmittance at this interface based on the Index of Refraction specified in the Material Properties for the two objects (the Fresnel reflection and transmission coefficients).
2. Surface Property applied to one coincident surface only while the other surface has the Surface Property of <None> - TracePro will use the parameters of the single defined surface property to determine the flux and direction of the resulting rays.
3. Surface Properties applied to both coincident surfaces - Although this condition is somewhat nonsensical and is not recommended, TracePro will combine the two surface properties in accordance with the equations below:

$$R_c = R_1 + \frac{T_1^2 \cdot R_2}{1 - (R_1 \cdot R_2)}, \quad (7.20)$$

$$T_c = \frac{T_1 \cdot T_2}{1 - (R_1 \cdot R_2)}, \text{ and} \quad (7.21)$$

$$A_c = A_1 + \frac{T_1 \cdot ((A_1 \cdot R_2) + A_2)}{1 - (R_1 \cdot R_2)}, \quad (7.22)$$

where R_1 , T_1 , and A_1 are the reflectance, transmittance, and absorptance, respectively, of the first coincident surface; R_2 , T_2 , and A_2 are the reflectance, transmittance, and absorptance, respectively, of the second coincident surface; and R_c , T_c , and A_c are the reflectance, transmittance, and absorptance, respectively, of the resulting combined property.

Note that other surface properties, such as the BSDF (BRDF or BTDF) are found in an analogous method.

BSDF

The Bidirectional Scattering Distribution Function (BSDF) is a measure of the light scattered from a surface in different directions. The BSDF is a function of both the incident direction and the scattering direction, hence the term bidirectional. Mathematically, the BSDF is defined as the scattered *radiance* per unit incident *irradiance*, or

$$\text{BSDF}(\theta_i, \phi_i, \theta_s, \phi_s) = \frac{dL_s(\theta_s, \phi_s)}{dE_i(\theta_i, \phi_i)}. \quad (7.23)$$

Because radiance has units watts/m²-sr and irradiance has units watts/m², the BSDF has units 1/sr (inverse steradians). Note that this equation for BSDF takes into account the projection of the surface “emitting” the scattered radiation, thus you can view Equation 7.23 as

$$\text{BSDF} = \frac{P_{scat}/\Omega}{P_{inc} \cdot \cos\theta_{scat}}. \quad (7.24)$$

where P_{scat} is the scattered power, P_{inc} is the incident power, Ω is the solid angle upon scattering, and θ_{scat} is the scatter angle from the normal to the scatter location. To remove this cosine dependence, you must post process in other software such as Excel.

In TracePro, the BSDF model is shift-invariant with respect to the incident direction. This property of BSDFs for polished surfaces was discovered by Harvey in his doctoral dissertation (See “Harvey-Shack BSDF” on page 7.16.). This means that the shape of the BSDF depends only on the difference between the specular direction and the scattered direction. This type of model is useful for a wide variety of surfaces, particularly optically polished surfaces.

The BSDF is really a generic term for scattering from surfaces. There are three specific types of BSDF:

- BRDF (Bidirectional Reflectance Distribution Function)
- BTDF (Bidirectional Transmittance Distribution Function)
- BDDF (Bidirectional Diffraction Distribution Function)

Harvey-Shack BSDF

In his dissertation (J. E. Harvey, “Light-Scattering Properties of Optical Surfaces,” Ph.D. Dissertation, U. Arizona, 1976) Harvey found that for many optical surfaces, the BSDF is independent of the direction of incidence if it is expressed as a function of direction cosines instead of angles. Harvey called this property “shift-invariant,” as in linear systems theory. Referring to Figure 7.4, β_0 is a projection onto the surface of the unit vector \mathbf{r}_0 in the specular direction, β is a projection onto the surface of the unit vector \mathbf{r} in the scattering direction, and the magnitude of their difference, $|\beta - \beta_0|$, is the argument of the BSDF. Note that β and β_0 are not unit vectors. They are projections of unit vectors, so their lengths are less than or equal to one. The Harvey-Shack method gives a good model for the behavior of most optical surfaces, i.e. those for which:

- Scattering is due mainly to surface roughness
- Scattering (and thus surface roughness) is isotropic
- Surface roughness is small compared to the wavelength of light

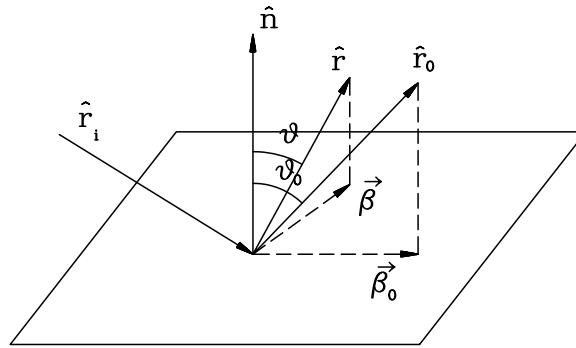

FIGURE 7.4 - Harvey-Shack BSDF: a shift-invariant BSDF representation

When measuring or evaluating the BSDF in the plane of incidence, i.e., when the scattering direction \mathbf{r} lies in the same plane as the incident and specular directions \mathbf{r}_i and \mathbf{r}_0 , the value of $|\beta - \beta_0|$ reduces to $|\sin\theta - \sin\theta_0|$, where θ is the angle between the scattering direction and the surface normal, and θ_0 is the angle between the specular direction and the surface normal. For light incident normal to the surface, $\theta_0 = 0$ and so $|\beta - \beta_0| = \sin\theta$. Measurements are often made only in the plane of incidence, and many BSDF plots have $|\sin\theta - \sin\theta_0|$, $\sin\theta - \sin\theta_0$, $\sin\theta$, or θ as the horizontal axis.

ABg BSDF Model

The BSDF model used in TracePro is a quasi-inverse-power-law model called the ABg model. It is called the ABg model because of the three parameters in the following equation,

$$\text{BSDF} = \frac{A}{B + |\vec{\beta} - \vec{\beta}_0|^g}, \quad (7.25)$$

where A, B, and g are parameters that can be used to fit the formula to measured data.

A typical ABg model BSDF, graphed on a log-log scale, is shown in Figure 7.5.

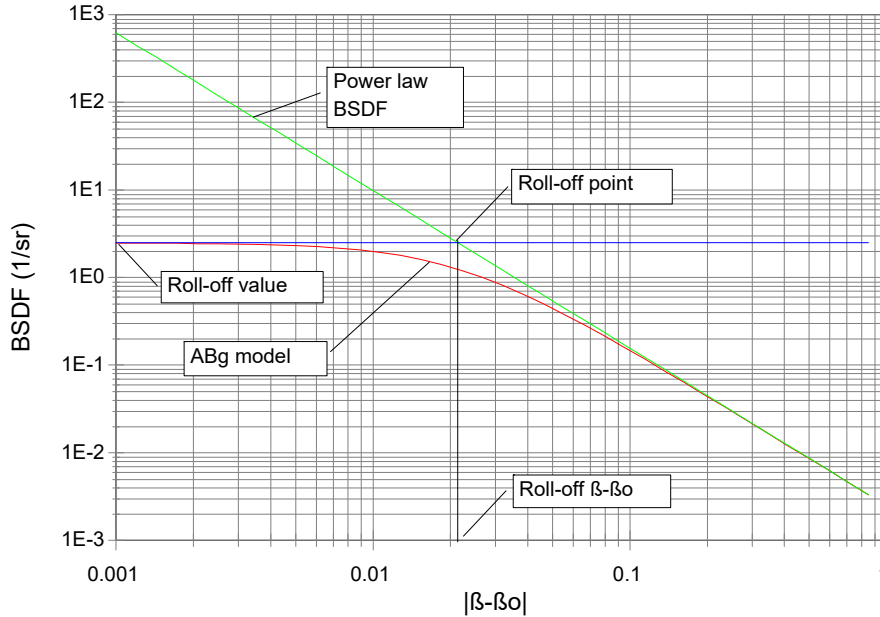

FIGURE 7.5 - ABg BSDF Model where A=0.0025, B=0.001, and g=1.8

Note the following properties of the ABg BSDF model:

- B must be greater than zero unless g is zero.
- If g is zero, it becomes a Lambertian BSDF with value $A/(B+1)$, and total integrated scatter equal to $\pi A/(B+1)$.
- If g is less than zero, the BSDF increases with $|\beta-\beta_0|$. Some surfaces display this behavior.

Most optically polished surfaces exhibit a BSDF with a shape that is well fit by this model. The model has a flat region at small values of $|\beta-\beta_0|$, a transition region around the roll-off point, and a region of nearly constant slope equal to $(-g)$ at large values of $|\beta-\beta_0|$. Values of g typically are between 1 and 3 depending on substrate material, polishing method, and degree of polish. Values of B are typically 0.001 or smaller, and values of A vary widely. The value of the BSDF at $|\beta-\beta_0|=0$, where the curve “flattens out” is given by

$$\text{BSDF}(0) = A/B. \tag{7.26}$$

The value of $|\beta-\beta_0|$ at which the curve rolls off, i.e., the roll-off $|\beta-\beta_0|$ in the curve above, determines the parameter B. B is related to the roll-off $|\beta-\beta_0|$ and g by

$$B = (\beta_{\text{rolloff}})^g. \tag{7.27}$$

BRDF, BTDF, and TS

BSDF is an abbreviation for Bidirectional Scattering Distribution Function. BSDF is a generic term. Specific terms used for describing scattering are:

- BRDF — Bidirectional Reflectance Distribution Function

- BTDF — Bidirectional Transmittance Distribution Function

These quantities refer to reflective and transmissive scattering, respectively. When defining a Surface Property in TracePro, you can define both the BRDF and the BTDF.

A quantity associated with the BSDF is the Total Scatter, or TS. In TracePro, the TS is defined as the integral of the BSDF over all angles,

$$TS = \int_0^{2\pi} \int_0^{2\pi} BSDF(\theta_i, \phi_i, \theta_s, \phi_s) \cos \theta \sin \theta (d\theta) d\phi, \quad (7.28)$$

where θ and ϕ are spherical polar coordinates defined with the surface normal as the z axis. For light incident normal to a surface, θ_i and ϕ_i are zero, and $\theta_s = \theta$ and $\phi_s = \phi$, and the TS is

$$TS = \int_0^{2\pi} \int_0^{2\pi} BSDF(0, 0, \theta_s, \phi_s) \cos \theta \sin \theta (d\theta) d\phi. \quad (7.29)$$

In order for TracePro to conserve energy, all the light incident on a surface must be accounted for in a surface property. This means the sum of the coefficients for absorption, specular reflection and transmission, and scattering, must equal one,

$$a + R_S + T_S + R_{TS} + T_{TS} = 1, \quad (7.30)$$

where a = absorptance

R_S = specular reflectance

T_S = specular transmittance

R_{TS} = TS for reflection

T_{TS} = TS for transmission.

When you edit an existing Surface Property or add a new one, TracePro will not let you leave the Surface Property Editor if this conservation of energy equation is not satisfied. You have the option of having TracePro solve for any of these quantities in the editor.

Asymmetric BSDF

An asymmetric BSDF is one that is not cylindrically symmetric in direction cosine space. Asymmetric BSDFs in TracePro include the elliptical BSDF models, which have mirror symmetry about two orthogonal axes, the one-dimensional BSDF models, and the Asymmetric Table BSDF, which in general has no symmetry.

When you apply an asymmetric BSDF to a surface, a reference axis for the asymmetry must also be specified. There are two ways to do this in TracePro. You can either:

- Specify a fixed reference axis (use this for most asymmetric BSDFs).
- Specify that the reference axis “floats” with the plane of incidence.

This choice is controlled by the *Use fixed axis for zero-azimuth for asymmetric scatter* checkbox in the *Surface* pane of the **Apply Properties** dialog box. In most cases, you should check this check-box and enter the direction cosines of a reference axis in the Anisotropic Axis tab. The Anisotropic Axis is also used for the reference axis for the BSDF.

A useful hint to decide whether to use the *Use fixed axis for zero-azimuth for asymmetric scatter* option is as follows: If, when you shine light on your surface, the asymmetric scatter pattern rotates as you rotate the substrate, choose *Use fixed axis for zero-azimuth for asymmetric scatter*. If, on the other hand, the asymmetry of the scatter remains **stationary** as you rotate the substrate, you should **uncheck** the *Use fixed axis for zero-azimuth for asymmetric scatter* option.

When you apply a surface property with an elliptical BSDF, the x axis is the zero-azimuth axis, and the z axis is the surface normal. The y axis is determined by the right-hand rule.

The geometry for scattering is shown in Figure 7.6 for the *Use fixed axis for zero-azimuth for asymmetric scatter* option, and in Figure 7.7 for the unchecked option, in which the x axis or zero-azimuth axis always orthogonal to the plane of incidence. The plane of incidence is the plane containing the incident direction and the surface normal.

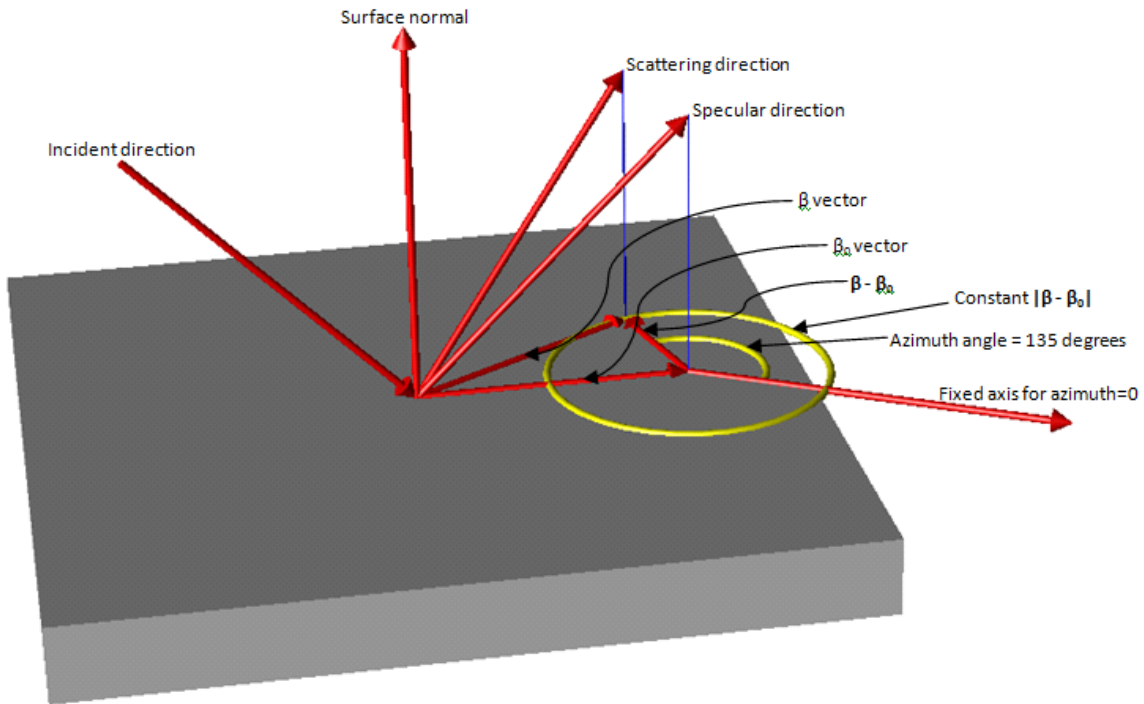

FIGURE 7.6 - Scattering geometry for the *Use fixed axis for zero-azimuth for asymmetric scatter* option.

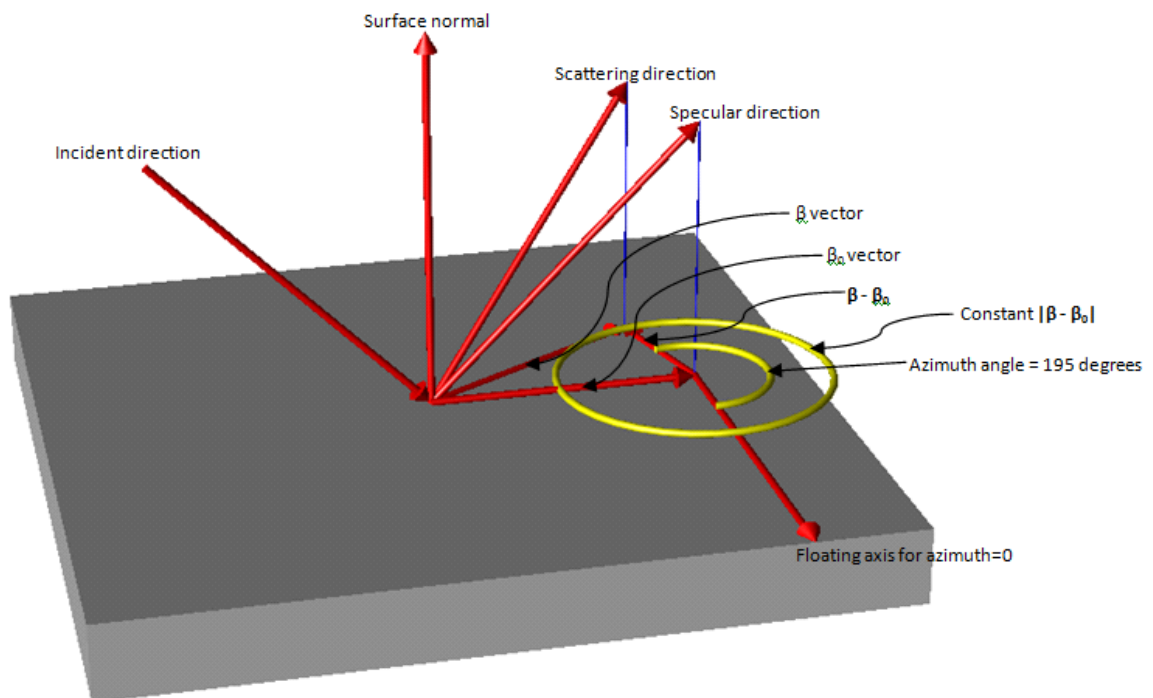

FIGURE 7.7 - Scattering geometry with the *Use fixed axis for zero-azimuth for asymmetric scatter* option unchecked.

Asymmetric Table BSDF

An asymmetric table BSDF model uses a table of BSDF values to specify the BSDF. The table is rectangular, i.e. you enter a list of $|\beta - \beta_0|$ values and azimuth values, and enter a BRDF and BTDF value for every combination of $|\beta - \beta_0|$ and azimuth. The beta coordinates are linear in plane of the surface as shown in Figure 7.6 and Figure 7.7. Therefore, the ring of constant $|\beta - \beta_0|$ represents one value of $|\beta - \beta_0|$, and the the azimuth angles for that $|\beta - \beta_0|$ value are different points spaced around the ring.

It is helpful to think of the $|\beta - \beta_0|$ and azimuth as plane polar coordinates, with $|\beta - \beta_0|$ as the radius coordinate. The plane for these coordinates is the tangent plane, the origin is the projection of the specular direction onto the tangent plane (i.e. the tip of the β_0 vector), and the azimuth=0 axis is the local x axis.

Elliptical BSDF

An elliptical BSDF is one that has coefficients that are elliptically interpolated, and therefore produces an asymmetric distribution of scattered light. An elliptical BSDF is one particular kind of asymmetric BSDF. The ABg model in TracePro is

symmetric versus $|\beta - \beta_0|$ whereas the elliptical BSDF is asymmetric. Two elliptical BSDF models are available in TracePro: elliptical ABg and elliptical Gaussian.

When you create a surface property with elliptical BSDF in TracePro, the ellipse that determines the orientation of the scatter is defined by x and y axes. You must enter coefficients along for of the axes. The direction of the x axis is specified when apply the surface property to a surface. If you make an anisotropic surface property with an elliptical BSDF, one direction vector serves to orient both the anisotropic coefficients and the scattering ellipse. When you create an anisotropic surface property, you can add as many values of θ and ϕ as you wish to the property. For each temperature and wavelength, the surface property editor will create a table of coefficients for each pair of θ and ϕ . For each pair of θ and ϕ , you enter the peak BSDF and the x and y coefficients of the BSDF.

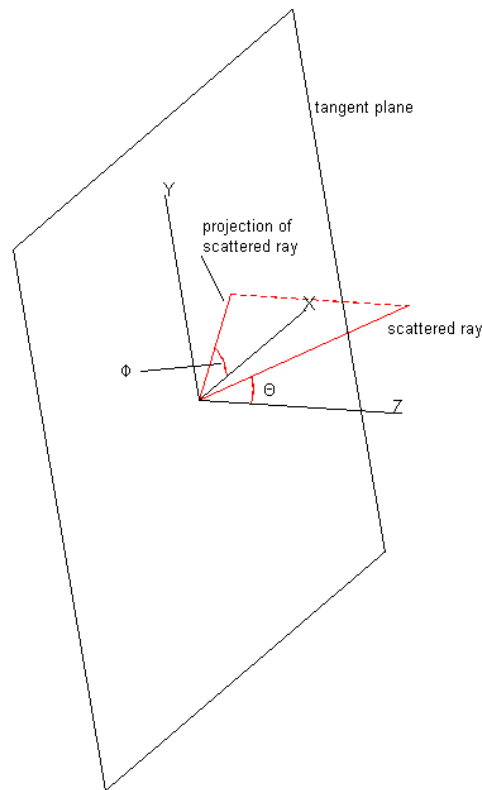

FIGURE 7.8 - Elliptical BSDF coordinates

Many surfaces exhibit asymmetric scattering behavior. Any surface that “looks different” from different directions is probably exhibiting asymmetric scattering. For example, a brushed or machined surface may scatter asymmetrically. Many composite materials that have fibers oriented in a particular direction exhibit asymmetric scattering. Some diffusers are designed to exhibit asymmetric scattering behavior, such as holographic diffusers.

Despite its versatility and generality, there are limitations to the capability of the TracePro elliptical BSDF. If you apply an elliptical BSDF surface property to a plane surface, the “grain” of the surface is fixed to one direction. To get the

elliptical BSDF to be spatially dependent (i.e. to be different on different parts of the surface) you would have to break up the object on which the surface resides into smaller pieces.

However, you can model circular brush marks on a parabolic reflector, for example. Because the “azimuth = 0” axis that you enter is projected onto the tangent plane in order to calculate the azimuth angle, the orientation of the azimuth = 0 axis determines the symmetry of the elliptical BSDF. Suppose the axis of the reflector is along the z axis in the figure above. To model brush marks that go around the reflector, you would enter the azimuth=0 axis as (0, 0, 1) or along the z axis. To make brush marks parallel to the axis of the reflector, enter an azimuth=0 axis perpendicular to the reflector axis, e.g. (1, 0, 0) or (0, 1, 0). To make elliptical brush marks at a skew angle, enter an azimuth=0 axis that is neither parallel nor perpendicular to the reflector axis.

Elliptical ABg BSDF model

The elliptical ABg BSDF model is based on the ABg model, which is symmetrical. The elliptical ABg model is so called because you specify the axes of an ellipse for each coefficient, and TracePro fits an ellipse to these axes to determine the coefficients in other directions. The elliptical ABg model is determined by the following algorithm:

1. When you create a surface property with elliptical BSDF, you enter B and g coefficients for x and y axes.
2. When you apply the property, you specify the azimuth=0 axis. This becomes the local x axis for determining the coefficients.
3. During the ray trace, the local surface normal and the azimuth=0 axis are used to construct a local coordinate system. The surface normal is the local z axis and the azimuth=0 axis is the local x axis. If the azimuth=0 axis is not perpendicular to the surface normal, a new x axis is created by rotating the azimuth=0 vector in a plane containing it and the normal such the x axis is perpendicular to the normal (i.e. the local x axis lies in the tangent plane).
4. The direction of the scattered ray is projected onto the tangent plane and the azimuth angle ϕ is determined. See “Elliptical BSDF coordinates” on page 7.22.
5. The coefficients B' and g' are determined by making the x and y components axes of an ellipse,

$$\frac{1}{B'^2} = \frac{(\cos\phi)^2}{B_x^2} + \frac{(\sin\phi)^2}{B_y^2} \quad (7.31)$$

and

$$\frac{1}{g'^2} = \frac{(\cos\phi)^2}{g_x^2} + \frac{(\sin\phi)^2}{g_y^2} \quad (7.32)$$

6. The ABg BSDF is evaluated in the same way as for symmetrical ABg BSDF model, i.e.

$$\text{BSDF} = \frac{A}{B' + \left| \vec{\beta} - \vec{\beta}_0 \right|^{g'}} \quad (7.33)$$

7. Finally, the A coefficient is determined from

$$BSDF(0) = \frac{A}{B'} \quad (7.34)$$

or

$$A = BSDF(0) \cdot B' \quad (7.35)$$

where $BSDF(0)$ is the peak BSDF. When you create an elliptical ABg BSDF model, then, for each row you enter the following coefficients:

- Peak BRDF
- BRDF B_x
- BRDF B_y
- BRDF g_x
- BRDF g_y
- Peak BTDF
- BTDF B_x
- BTDF B_y
- BTDF g_x
- BTDF g_y

Elliptical Gaussian BSDF

The elliptical Gaussian BSDF has a much simpler form. You enter the peak BSDF and the $1/e^2$ half-width in either direction. Then the BSDF has the form

$$BSDF = BSDF(0)e^{-2\left(\frac{x^2}{s_x^2} + \frac{y^2}{s_y^2}\right)} \quad (7.36)$$

where $BSDF(0)$ is the peak BSDF. When you create an elliptical Gaussian BSDF model, then, for each row you enter the following coefficients:

- Peak BRDF
- BRDF s_x
- BRDF s_y
- Peak BTDF
- BTDF s_x
- BTDF s_y

The s_x and s_y values are the $1/e^2$ half-widths of the elliptical Gaussian BSDF in terms of $\beta-\beta_0$. For the case of normal incidence ($\beta_0 = 0$ deg), a $\beta-\beta_0$ value of 0.5 would equate to a $1/e^2$ half-width of 30 deg, $\sin(30)-\sin(0) = 0.5$.

1D ABg BSDF Model

The 1D ABg BSDF model is an asymmetrical BSDF model based on the ABg model, which is symmetrical. 1D BSDF models are used to model surfaces that scatter strongly in one plane, for example brushed or machined surfaces. The 1D

ABg model is a product of two orthogonal functions. Along the local x direction it is an ABg model, and along the local y direction it is a Gaussian.

1. When you create a surface property with 1D ABg BSDF, you enter B and g coefficients for the x axis, and a sigma value for the y axis.
2. When you apply the property, you specify the azimuth=0 axis. This becomes the local x axis for orienting the scatter pattern.
3. During the ray trace, the local surface normal and the azimuth=0 axis are used to construct a local coordinate system. The surface normal is the local z axis and the azimuth=0 axis is the local x axis. If the azimuth=0 axis is not perpendicular to the surface normal, a new x axis is created by rotating the azimuth=0 vector in a plane containing it and the normal such the x axis is perpendicular to the normal (i.e. the local x axis lies in the tangent plane).

When you create a 1D ABg BSDF model, then, for each row you enter the following coefficients:

- BRDF A
- BRDF B
- BRDF g
- BRDF sigma

1D Table BSDF Model

The 1D Table BSDF model is an asymmetrical BSDF model that uses a table of BSDF values along the +/-x direction, and a Gaussian along the y direction. 1D BSDF models are used to model surfaces that scatter strongly in one plane, for example brushed or machined surfaces. The 1D Table model is a product of two orthogonal functions. Along the local x direction it is a table of values, and along the local y direction it is a Gaussian.

1. When you create a surface property with 1D Table BSDF, you enter a table of values for the x axis, and a sigma value for the y axis.
2. When you apply the property, you specify the azimuth=0 axis. This becomes the local x axis for orienting the scatter pattern.
3. During the ray trace, the local surface normal and the azimuth=0 axis are used to construct a local coordinate system. The surface normal is the local z axis and the azimuth=0 axis is the local x axis. If the azimuth=0 axis is not perpendicular to the surface normal, a new x axis is created by rotating the azimuth=0 vector in a plane containing it and the normal such the x axis is perpendicular to the normal (i.e. the local x axis lies in the tangent plane).

The table of values along the x axis is versus positive and negative values of $(\beta - \beta_0)_x$ to enable asymmetry along the local x axis.

Calculation of Fresnel coefficients during raytrace

If the surface property is of type *Fresnel*, then the specular reflectance and transmittance coefficients must be calculated during the raytrace.

This is done in the following way:

- Calculate the absorptance, reflectance, and transmittance based on the material property.
- Use the calculated absorptance for the absorptance coefficient.
- Use the calculated reflectance for the total reflectance.
- Adjust the Total Scatter (TS) for the angle of incidence. The TS in the database is for normal incidence.

The adjusted TS for reflectance is

$$TS_{refl}(\theta) = TS_{refl}(0) \cdot \frac{R_{total}(\theta)}{R_{total}(0)}$$

The adjusted TS for transmittance is

$$TS_{trans}(\theta) = TS_{trans}(0) \cdot \frac{T_{total}(\theta)}{T_{total}(0)}$$

- Calculate the specular reflectance and transmittance as the total minus TS,

$$R_{spec}(\theta) = R_{spec}(\theta) - TS_{refl}(\theta)$$

and

$$T_{spec}(\theta) = T_{spec}(\theta) - TS_{trans}(\theta)$$

Anisotropic Surface Properties Standard Expert

According to the Merriam-Webster Collegiate Dictionary, anisotropic means:

Main Entry: **an·iso·trop·ic**

Pronunciation: "a-"nI-s&- 'tră-pik

Function: *adjective*

Date: 1879

: exhibiting properties with different values when measured in different directions

<an *anisotropic* crystal>

Anisotropic really means "not isotropic," and isotropic means (again according to the Merriam-Webster Collegiate Dictionary) "exhibiting properties (as velocity of light transmission) with the same values when measured along axes in all directions." For a surface property, anisotropic behavior means that the coefficients can vary versus the direction of incidence. In a TracePro surface property, the direction of incidence is described by two angles, a polar angle θ and an azimuth angle ϕ like in spherical coordinates. The polar angle is the angle between the incident ray and the surface normal. With the surface normal as the z axis, the x and y axes lie in a plane tangent to the surface as in Figure 7.9.

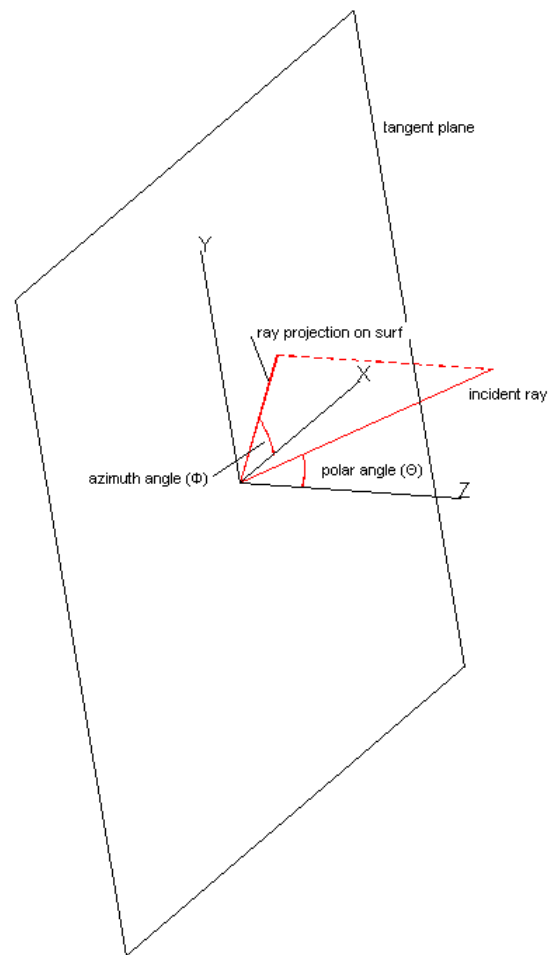

FIGURE 7.9 - Polar Coordinates for anisotropic surface property

When you create a surface property in TracePro, you can add as many values of θ and ϕ as you wish to the property. For each temperature and wavelength, the surface property editor will create a table of coefficients for each pair of θ and ϕ . For an anisotropic surface property, the BSDF can be either the standard ABg model or an elliptical or table BSDF model, giving you full control over the behavior of the surface.

When you apply an anisotropic surface property to a surface, you must also specify the direction where the azimuth angle is zero. This is the x axis in Figure 7.9.

Anisotropic surface types

Many surfaces exhibit anisotropic behavior. Any surface that “looks different” when light is shined from different directions is exhibiting anisotropic behavior. For example, a brushed or machined surface may reflect a different amount of light depending on the direction of incidence. Many composite materials that have fibers oriented in a particular direction exhibit anisotropy. Some diffusers are designed to exhibit anisotropic behavior.

Despite its versatility and generality, there are limitations to the capability of the TracePro anisotropic surface property. If you apply an anisotropic surface property to a plane surface, the “grain” of the surface is fixed to one direction. To get the anisotropy to be spatially dependent (i.e. to be different on different parts of the surface) you would have to break up the object on which the surface resides into smaller pieces, one for each anisotropy direction.

However, you can model circular brush marks on a parabolic reflector, for example. Because the “azimuth = 0” axis that you enter is projected onto the tangent plane in order to calculate the azimuth angle, the orientation of the azimuth = 0 axis determines the symmetry of the anisotropy. Suppose the axis of the reflector is along the z axis in Figure 7.9. To model brush marks that go around the reflector, you would enter the azimuth=0 axis as (0, 0, 1) or along the z axis. To make elliptical brush marks at a skew angle, enter an azimuth=0 axis that is neither parallel nor perpendicular to the reflector axis.

Getting anisotropic data

To obtain data for an anisotropic surface, you will probably have to make measurements from a sample of material. If you do not have the equipment and expertise to make these measurements, you can contract with any of several commercial labs to make the measurements. Lambda Research does not endorse any particular laboratory, but the quantity you need to measure is sometimes referred to as the Hemispherical Directional Reflectance or Transmittance Function, often abbreviated as HDRF or HDTF. This gives you the total reflectance or transmittance versus direction of incidence (by a reciprocity argument) but may or may not distinguish between specular and scattered components. The best way to separate these is to also make BRDF and/or BTDF measurements for several directions of incidence. So to fully characterize an anisotropic surface, you need two sets of measurements: HDRF/HDTF and BRDF/BTDF. For example, to create a surface property for an opaque surface (so that the specular transmittance and BTDF are zero) you would:

1. Obtain BRDF and HDRF measurements of a sample.
2. Fit the BRDF measurements using one of the BSDF models in TracePro.
3. Enter the BRDF coefficients into the surface property.
4. Calculate the absorptance versus θ and ϕ as $A = 1 - \text{HDRF}$ and enter into the surface property.
5. Solve for Reflectance in the surface property editor.

When you make the measurements, be sure that orientation of the sample with respect to the measurement apparatus is known. Define a local axis on the part, and reference all measurements to this axis. This will become the azimuth = 0 axis when you create the surface property in TracePro.

User Defined Surface Properties Expert

Overview

TracePro Expert provides interfaces for user defined properties using dynamic link libraries (DLLs). Currently Surface and Bulk Scatter properties are available.

To use these properties, you must create a DLL which will perform the property calculations and define a property in the property editor which may be applied to a surface or object in TracePro.

Creating a Surface Property DLL

To create a TracePro, first download the SourceFilesForCreatingPropertyDLLs.zip file from www.lambdare.com, in the Tech Support section under TracePro>Properties. Unzip the file to obtain a Microsoft Visual Studio Solution and a set of source files that serve as a template for the creation of a C++ DLL. Through this DLL interface, you can write custom surface properties that can be applied to surfaces within a TracePro model. When tracing rays, TracePro's raytrace engine will interact with these surface properties as prescribed by the your programmed instructions.

Currently, the following set of inputs and outputs are supported. Provisions have been made to expand the sets of inputs and/or outputs in the future. The delivered source files serve as further clarification and documentation of this implementation.

TABLE 7.1. Surface Property DLL Inputs

Description	Variable
wavelength	input[WAVELENGTH]
temperature	input[TEMPERATURE]
position X	input[RAY_POS_X]
position Y	input[RAY_POS_Y]
position Z	input[RAY_POS_Z]
incident direction X	input[RAY_DIR_X]
incident direction Y	input[RAY_DIR_Y]
incident direction Z	input[RAY_DIR_Z]
flux S0, (Stokes Vector)	input[RAY_FLUX_S0]
flux S1, (Stokes Vector)	input[RAY_FLUX_S1]
flux S2, (Stokes Vector)	input[RAY_FLUX_S2]
flux S3, (Stokes Vector)	input[RAY_FLUX_S3]
flux SX, (Stokes Vector)	input[RAY_FLUX_SX]
flux SY, (Stokes Vector)	input[RAY_FLUX_SY]
flux SZ, (Stokes Vector)	input[RAY_FLUX_SZ]
surface normal X	input[SURF_NORM_X]
surface normal Y	input[SURF_NORM_Y]
surface normal Z	input[SURF_NORM_Z]
n reflection side	input[N_REFL_SIDE]
k reflection side	input[K_REFL_SIDE]
n transmission side	input[N_TRAN_SIDE]
k transmission side	input[K_TRAN_SIDE]

TABLE 7.2. Surface Property DLL Outputs

By assigning as follows:
`results[SIGNAL_TO_TRACEPRO] =`
`COATING_DLL_SIGNAL_NONE`

Description	Variable
s - absorptance	results[ABSO_S]
p - absorptance	results[ABSO_P]
s - reflectance	results[REFL_S]
p - reflectance	results[REFL_P]
s - transmittance	results[TRAN_S]
p - transmittance	results[TRAN_P]
Phase reflection [deg]	results[PHAS_R]
Phase transmission [deg]	results[PHAS_T]

By assigning as follows:
`results[SIGNAL_TO_TRACEPRO] =`
`COATING_DLL_SIGNAL_USE_MUELLER_MATRIX`

Description	Variable
16 Mueller Matrix components for reflection	results[REFL_MM_xy] x -> 0 to 3 ; y-> 0 to 3
16 Mueller Matrix components for transmission	results[TRAN_MM_xy] x -> 0 to 3 ; y-> 0 to 3

By assigning as follows:
`results[SIGNAL_TO_TRACEPRO] =`
`COATING_DLL_SIGNAL_FULL_RAY_CONTROL`

Description	Variable
s - absorptance	results[ABSO_S]
p - absorptance	results[ABSO_P]
output direction X	results[RAYOUT_DIR_X]
output direction Y	results[RAYOUT_DIR_Y]
output direction Z	results[RAYOUT_DIR_Z]
output Stokes, S0	results[RAYOUT_FLUX_S0]
output Stokes, S1	results[RAYOUT_FLUX_S1]
output Stokes, S2	results[RAYOUT_FLUX_S2]
output Stokes, S3	results[RAYOUT_FLUX_S3]
output Stokes, SX	results[RAYOUT_FLUX_SX]
output Stokes, SY	results[RAYOUT_FLUX_SY]
output Stokes, SZ	results[RAYOUT_FLUX_SZ]

After unzipping the downloaded zip file, you will find the following:

- **TraceProDLLs.h**
header file shared with TracePro defines the array subscripts to the input and output arrays should be included in each new Surface Property DLL

- \SurfacePropDll
folder that contains source, project, and workspace files as an example for writing your own DLL.

The following steps can be used to create and use your DLL:

1. Copy the SurfacePropDll folder and its contents to a new folder.
2. Open the solution file in Microsoft Visual Studio.
3. Add your code to the source files surf.h and surf.cpp
4. Build the DLL. The name of the DLL from this solution will be surf.dll.
5. Within TracePro's Surface Property Editor, create a new surface property. Set the "Type:" to "Coating DLL" and browse to the DLL's location on the disk.
6. You may now apply this surface property to any surface in a TracePro model using the Apply properties dialog box.
7. When applying this type of surface property you must also supply an origin, normal direction, and up direction. This will identify the local coordinate system of the property in the model's global coordinate system.
8. After debugging your work, move and rename the DLL. It may be moved to any convenient location.
9. After renaming the DLL, go back and modify the surface property to identify the new location of the DLL.

Create the Surface Property

DLL properties are created in a similar manner to standard surface properties. Add a new property using the *Add Surface Property* button and set the Type to Coating DLL. The Specular data is provided in the DLL. Scattering data may be added separately in the property editor.

Apply Surface Property

The Apply Surface Property dialog provides additional data for DLL properties (see Figure 7.10). An *Origin*, *Normal Direction* (normal vector) and *Up Direction* (up vector) are available to orient the property to the surface. This data permits spatially varying properties. The normal and up vectors will be transformed when the object is rotated and the origin will be translated when the object is moved. A *User Param* (user parameter) cell is also available as a storage place for data that you want to keep with the Surface Property. A standard Windows browse button:



is placed to the right of the *User Param* cell in case you want to easily determine a file location path to store in the *User Param* cell.

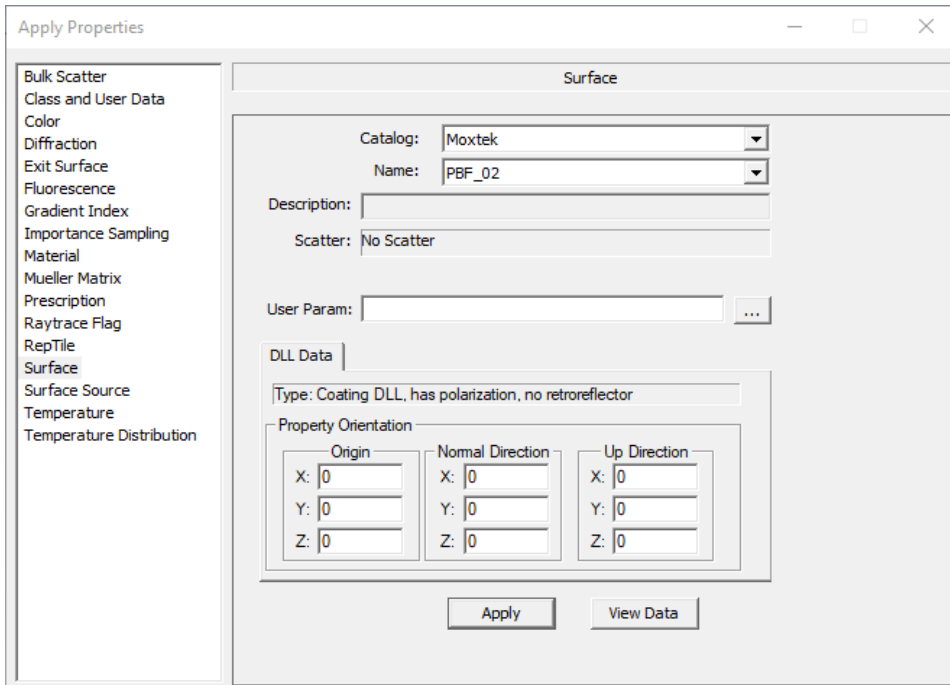

FIGURE 7.10 - Elliptical BSDF coordinates

API Specification for Enhanced Coating DLL

While the Enhanced Coating DLL requires programming experience from the user it provides the following features:

- Spatial variation of surface properties including reflection, absorption, transmission,
- All surface properties can be functions of wavelength, temperature, and other parameters,
- Individual control of the Stokes vectors for rays, and
- Assign Mueller Matrices to surfaces rather than objects.

Simply said, this API allows you to enter complex surface properties through their own C++ programming structures. It can be thought as analogous to RepTile but rather than affecting the geometry it affects the coating properties on that surface. This section provides a bit more understanding of how to use set up such DLLs, but by no means is it complete - there are just too many options possible with this API!

The following API specification identifies all function calls and parameters passed between the main executable, TracePro, and the Enhanced Coating DLL (herein referred to as "DLL"). This functionality requires the Expert edition of TracePro. All references to "TracePro" within this section imply TracePro Expert.

The header files (*.h) constitute a key portion of this document. The header files are shipped with TracePro in electronic form. In the event that a shipped header file differs from the description shown in this document, the shipped header file takes precedence since it was actually used in the compilation of the software. Please notify Lambda of any discrepancies and this document will be updated.

Document Layout

This specification identifies and describes function calls made by TracePro into the DLL. A syntax sheet is provided for each function, identifying and explaining the following:

- The frequency by which the function is called by TracePro,
- The parameters passed by TracePro to each function, and
- The parameters returned by each function to TracePro.

Calling Frequencies

The following calling frequencies apply:

- Per Simulation - Functions with this frequency are called once per simulation/analysis (hereafter called simulation). A simulation consists of two phases: an audit phase and a raytrace phase.
- Per Wavelength - Functions with this frequency are called once per wavelength ray trace. This occurs in a portion of the audit phase. Once the raytrace phase begins, the raytrace proceeds one wavelength at a time. As the simulation switches from one wavelength to another, this portion of the audit phase is executed to update the model for the next wavelength to be traced.
- Per Surface - Functions with this frequency are called once for each surface in the TracePro model. These functions are called in the audit phase of the simulation.
- Per Surface Intersection -- Functions with this frequency are called each time a ray intersects a surface with a Coating DLL type surface property on it. These functions are called in the raytrace phase of the simulation.

Return Codes, Signals, and Constants -- TraceProDLL.h

All return codes, signals, and constants are defined in the C++ header file, TraceProDLL.h. This header file is included when TracePro is compiled and built. The default location is:

```
C:\Program Files\Lambda Research Corporation\TracePro\DLLs
```

DLL writers should use the definitions provided herein and not hard code numbers when their usage is warranted.

Description of Return Codes

The return codes for functions in the DLL are broken into two categories. One set for functions returning a double value; and another set for functions returning an integer value. The two sets mirror each other.

Double:

- OK and no message to be output by TracePro:

```
const double COATING_DLL_RETURN_CODE_OK = (double)0;
```

- OK and TracePro to output message:

```
const double COATING_DLL_RETURN_CODE_OK_WITH_MESSAGE =  
(double)1;
```

- Error, TracePro to output message, but keep processing:

```
const double COATING_DLL_RETURN_CODE_ERROR_GENERAL =  
(double)2;
```

- Error, TracePro to output message, and stop processing:

```
const double COATING_DLL_RETURN_CODE_ERROR_CRITICAL = (double)3;
```

Integer:

- OK and no message to be output by TracePro:

```
const int COATING_DLL_IRC_OK = 0;
```

- OK and TracePro to output message:

```
const int COATING_DLL_IRC_OK_WITH_MESSAGE = 1;
```

- Error, TracePro to output message, but keep processing:

```
const int COATING_DLL_IRC_ERROR_GENERAL = 2;
```

- Error, TracePro to output message and stop processing::

```
const int COATING_DLL_IRC_ERROR_CRITICAL = 3;
```

Function: fnInitDll

Calling Frequency:

Per Surface

Function Prototype:

```
//Function address for TracePro random number generator  
typedef double (*RAND_FN)(void);  
RAND_FN random_function;  
  
double fnInitDll(  
    RAND_FN address,  
    // the following parameters have defaults for backward  
    compatibility  
    long nUniqueSurfaceID = 0,  
    LPTSTR szMessage = ""  
);
```

Description:

This is an initialization function called by TracePro to setup the random number generator for use by the DLL. This function is also the first announcement of the unique surface identifier. The writer of the DLL should use this function to store this unique surface ID in a variable for use throughout the DLL.

Parameters:**nUniqueSurfaceID:**

unique surface ID established during the audit phase of the simulation

Data flow direction: TracePro > DLL

szMessage:

message sent to TracePro's message window if the return code is non-zero

Data flow direction: DLL > TracePro

Function: fnEvaluateCoating**Calling Frequency:**

Per Surface Intersection

Function Prototype:

```
double fnEvaluateCoating(
double* input,
int input_size,
double* user,
int user_size,
double* results,
int results_size,
// the following parameters have defaults for backward
compatibility
long nUniqueSurfaceID = 0,
LPTSTR szMessage = ""
);
```

Description:

The fundamental communication link between TracePro and the DLL in the evaluation function, fnEvaluateCoating, is primarily through the use of 2 arrays, called the "input" array and the "results" array.

Parameters:

NOTE: nUniqueSurfaceID and szMessage have the same meaning as described in the other functions.

The "input" array description:

Data flow direction: TracePro > DLL

Description

Wavelength

Temperature

position X

Variable

input[WAVELENGTH]

input[TEMPERATURE]

input[RAY_POS_X]

position Y	input[RAY_POS_Y]
position Z	input[RAY_POS_Z]
incident direction Xi	input[RAY_DIR_X]
incident direction Y	input[RAY_DIR_Y]
incident direction Z	input[RAY_DIR_Z]
flux S0, (Stokes Vector)	input[RAY_FLUX_S0]
flux S1, (Stokes Vector)	input[RAY_FLUX_S1]
flux S2, (Stokes Vector)	input[RAY_FLUX_S2]
flux S3, (Stokes Vector)	input[RAY_FLUX_S3]
flux SX, (Stokes Vector)	input[RAY_FLUX_SX]
flux SY, (Stokes Vector)	input[RAY_FLUX_SY]
flux SZ, (Stokes Vector)	input[RAY_FLUX_SZ]
surface normal X	input[SURF_NORM_X]
surface normal Y	input[SURF_NORM_Y]
surface normal Z	input[SURF_NORM_Z]
n reflection side	input[N_REFL_SIDE]
k reflection side	input[K_REFL_SIDE]
n transmission side	input[N_TRAN_SIDE]
k transmission side	input[K_TRAN_SIDE]

The "results" array description:

Data flow direction: DLL > TracePro

Depending on the value assigned to the results[SIGNAL_TO_TRACEPRO], the results array will be interpreted differently by TracePro. There are three signals that TracePro will recognize. They are:

- COATING_DLL_SIGNAL_NONE
- COATING_DLL_SIGNAL_USE_MUELLER_MATRIX
- COATING_DLL_SIGNAL_FULL_RAY_CONTROL

1. By assigning as follows:

```
results[SIGNAL_TO_TRACEPRO] = COATING_DLL_SIGNAL_NONE;
```

TracePro will recognize the following variables in the results array:

<u>Description</u>	<u>Variable</u>
s - absorptance	results[ABSO_S]
p - absorptance	results[ABSO_P]
s - reflectance	results[REFL_S]
p - reflectance	results[REFL_P]
s - transmittance	results[TRAN_S]

p - transmittance	results[TRAN_P]
Phase reflection [deg]	results[PHAS_R]
Phase transmission [deg]	results[PHAS_T]

2. By assigning as follows:

```
results[SIGNAL_TO_TRACEPRO]=COATING_DLL_SIGNAL_USE_MUELLER_MATRIX;
```

TracePro will also recognize the following variables in the results array (the above variables for case 1 are also used):

Description: 16 Mueller Matrix components for reflection

Variable: results[REFL_MM_xy] for x -> 0 to 3 ; y-> 0 to 3

Description: 16 Mueller Matrix components for transmission

Variable: results[TRAN_MM_xy] for x -> 0 to 3 ; y-> 0 to 3

3. By assigning as follows:

```
results[SIGNAL_TO_TRACEPRO] =COATING_DLL_SIGNAL_FULL_RAY_CONTROL;
```

TracePro will recognize the following variables in the results array:

<u>Description</u>	<u>Variable</u>
s - absorptance	results[ABSO_S]
p - absorptance	results[ABSO_P]
output direction X	results[RAYOUT_DIR_X]
output direction Y	results[RAYOUT_DIR_Y]
output direction Z	results[RAYOUT_DIR_Z]
output Stokes, S0	results[RAYOUT_FLUX_S0]
output Stokes, S1	results[RAYOUT_FLUX_S1]
output Stokes, S2	results[RAYOUT_FLUX_S2]
output Stokes, S3	results[RAYOUT_FLUX_S3]
output Stokes, SX	results[RAYOUT_FLUX_SX]
output Stokes, SY	results[RAYOUT_FLUX_SY]
output Stokes, SZ	results[RAYOUT_FLUX_SZ]

When TracePro is sent the new signal:

```
COATING_DLL_SIGNAL_FULL_RAY_CONTROL,
```

the 10 quantities (for direction and flux) are used in conjunction with two existing array elements, ABSO_S and ABSO_P, to control the next ray node to propagate from the surface.

Surface absorption will occur based on the values of the ABSO_S and ABSO_P array elements. This will yield a convenient way to terminate rays by setting these to unity.

Only one ray is generated from the surface. **Energy conservation, if desired, is controlled by the writer of the DLL.** The energy conservation equation is:

```
results[RAYOUT_FLUX_S0] ==  
input[RAY_FLUX_S0] *  
( 1 - 0.5 * results[ABSO_S] - 0.5 * results[ABSO_P] )
```

The writer of the DLL assumes the responsibility of supplying a valid Stokes vector. TracePro will not perform any error checking for this. A valid Stokes vector must satisfy these conditions:

```
results[RAYOUT_FLUX_S0] >= 0.0  
  
and  
  
(results[RAYOUT_FLUX_S0])^2 >=(results[RAYOUT_FLUX_S1])^2 +  
                                (results[RAYOUT_FLUX_S2])^2 +  
                                (results[RAYOUT_FLUX_S3])^2
```

Function: fnAnnounceOMLPath

Calling Frequency:

Per Simulation

Function Prototype:

```
int fnAnnounceOMLPath(  
LPCTSTR szPath,  
long nUniqueSurfaceID,  
LPTSTR szMessage  
);
```

Description:

This function announces the full filename, including the path, of the OML file. If the simulation is run before the file is saved, the empty string is sent to the DLL.

Parameters:

szPath:

full filename of OML file including path

Data flow direction: TracePro > DLL

nUniqueSurfaceID:

unique surface ID established during the audit phase of the simulation

Data flow direction: TracePro > DLL

szMessage:

message sent to TracePro's message window if the return code is non-zero

Data flow direction: DLL > TracePro

Function: fnAnnounceDataDirectory**Calling Frequency:**

Per Simulation

Function Prototype:

```
int fnAnnounceDataDirectory(  
LPCTSTR szDataDir,  
long nUniqueSurfaceID,  
LPTSTR szMessage  
);
```

Description:

This function announces the data directory to the DLL. In TracePro (3.3.X +), this is entered through the View|Customize menu selection.

Parameters:**szDataDir:**

data directory specified to TracePro

Data flow direction: TracePro > DLL

nUniqueSurfaceID:

unique surface ID established during the audit phase of the simulation

Data flow direction: TracePro > DLL

szMessage:

message sent to TracePro's message window if the return code is non-zero

Data flow direction: DLL > TracePro

Function: fnAnnounceSurfaceInfo**Calling Frequency:**

Per Surface

Function Prototype:

```
int fnAnnounceSurfaceInfo (  
LPCTSTR szObjectName,  
LPCTSTR szSurfaceName,  
LPCTSTR szSurfacePropertyCatalog,
```

```
LPCTSTR szSurfacePropertyName,  
LPCTSTR szCustomizedSurfaceParameter,  
long nUniqueSurfaceIDLPTSTR szMessage);
```

Description:

This function announces various surface information to the DLL.

Parameters:**szObjectName:**

name of this surface's object

Data flow direction: TracePro > DLL

szSurfaceName:

the surface name

Data flow direction: TracePro > DLL

szSurfacePropertyCatalog:

the catalog in which this surface's surface property resides

Data flow direction: TracePro > DLL

szSurfacePropertyName:

the name of the surface property applied to this surface

Data flow direction: TracePro > DLL

szCustomizedSurfaceParameter:

customized surface parameter entered from the Apply Properties dialog box when applying the surface property

Data flow direction: TracePro > DLL

nUniqueSurfaceID:

unique surface ID established during the audit phase of the simulation

Data flow direction: TracePro > DLL

szMessage:

message sent to TracePro's message window if the return code is non-zero

Data flow direction: DLL > TracePro

Function: fnAnnounceLocalBoundingBox

Calling Frequency:

Per Surface

Function Prototype:

```
int fnAnnounceLocalBoundingBox(
```

```
double* LocalBoundingBox,
long nUniqueSurfaceID,
LPTSTR szMessage
);
```

Description:

This function announces the three orthogonal dimensional extents of a bounding box in the local coordinate system specified by the user.

Parameters:**LocalBoundingBox:**

LocalBoundingBox is an array of 6 double values which contains the X, Y, and Z-dimension limits of local bounding box. These limits are with respect to the coordinate system defined by the origin, normal vector, and up vector when applying the surface property to this surface. The six individual elements of the array are obtained as follows:

```
LocalBoundingBox[BOX_XMIN],
LocalBoundingBox[BOX_XMAX],
LocalBoundingBox[BOX_YMIN],
LocalBoundingBox[BOX_YMAX],
LocalBoundingBox[BOX_ZMIN], and
LocalBoundingBox[BOX_ZMAX]
```

Data flow direction: TracePro > DLL

nUniqueSurfaceID:

unique surface ID established during the audit phase of the simulation

Data flow direction: TracePro > DLL

szMessage:

message sent to TracePro's message window if the return code is non-zero

Data flow direction: DLL > TracePro

Function: fnAnnounceRaytraceStart**Calling Frequency:**

Per Simulation

Function Prototype:

```
int fnAnnounceRaytraceStart(
long nUniqueSurfaceID,
LPTSTR szMessage
);
```

Description:

This function announces the start of the raytrace.

Parameters:

nUniqueSurfaceID:

unique surface ID established during the audit phase of the simulation

Data flow direction: TracePro > DLL

szMessage:

message sent to TracePro's message window if the return code is non-zero

Data flow direction: DLL > TracePro

Function: fnAnnounceWavelengthStart

Calling Frequency:

Per Wavelength

Function Prototype:

```
int fnAnnounceWavelengthStart(  
double wavelength,  
long nUniqueSurfaceID,  
LPTSTR szMessage  
);
```

Description:

This function announces the start of the raytrace for a particular wavelength

Parameters:

wavelength:

the wavelength, in microns, that will be raytraced next

Data flow direction: TracePro > DLL

nUniqueSurfaceID:

unique surface ID established during the audit phase of the simulation

Data flow direction: TracePro > DLL

szMessage:

message sent to TracePro's message window if the return code is non-zero

Data flow direction: DLL > TracePro

Function: fnAnnounceWavelengthFinish

Calling Frequency:

Per Wavelength

Function Prototype:

```
int fnAnnounceWavelengthFinish(  
double wavelength,  
long nUniqueSurfaceID,  
LPTSTR szMessage  
);
```

Description:

This function announces the completion of the raytrace for a particular wavelength.

Parameters:**wavelength:**

the wavelength, in microns, that was just raytraced

Data flow direction: TracePro > DLL

nUniqueSurfaceID:

unique surface ID established during the audit phase of the simulation

Data flow direction: TracePro > DLL

szMessage:

message sent to TracePro's message window if the return code is non-zero

Data flow direction: DLL > TracePro

Function: fnAnnounceRaytraceFinish

Calling Frequency:

Per Simulation

Function Prototype:

```
int fnAnnounceRaytraceFinish(  
int nStatus,  
long nUniqueSurfaceID,  
LPTSTR szMessage  
);
```

Description:

This function announces the completion of the raytrace.

Parameters:

nStatus:

the raytrace finishing status

one of the following const values will be sent by TracePro:

```
const int COATING_DLL_RAYTRACE_FINISH_OK = 0;
const int COATING_DLL_RAYTRACE_FINISH_USER_CANCEL = 1;
const int COATING_DLL_RAYTRACE_FINISH_CATCH_EXCEPTION = 2;
const int COATING_DLL_RAYTRACE_FINISH_CRITICAL_ERROR_FROM_DLL = 3;
```

Data flow direction: TracePro > DLL

nUniqueSurfaceID:

unique surface ID established during the audit phase of the simulation

Data flow direction: TracePro > DLL

szMessage:

message sent to TracePro's message window if the return code is non-zero

Data flow direction: DLL > TracePro

Example of Enhanced Coating DLL

Provided here is an example of an enhanced coating DLL. It is a variable transmission (and reflection) filter as a function of radial position. The equations that governs the transmission (T) and reflection (R) are

$$T = 1 - r/r_{max} \quad \text{and} \quad (7.37)$$

$$R = 1 - T = r/r_{max}, \quad (7.38)$$

where r is the local radius of the ray on the applied surface and rmax is maximum radius of the surface, which is hard-coded to a value of 5 as shown below.

The programming of interest in the DLL is:

```
////////////////////////////////////
// End of example
////////////////////////////////////
SURF_API double fnEvaluateCoating(
    double*input,
    int      input_size,
    double*user,
    int      user_size,
    double*results,
    int      results_size
)
```

```

{
double result_val = 0;

// zero-out the results array
memset(results,0,sizeof(double)*results_size);
results[SIGNAL_TO_TRACEPRO] = COATING_DLL_SIGNAL_NONE;

double x = input[RAY_POS_X];
double y = input[RAY_POS_Y];
double r = sqrt( x*x + y*y );
double rMax = 5.0;
double tran = 1.0 - r/rMax;

if( tran < 0.0 )
    tran = 0.0;

results[TRAN_S] = results[TRAN_P] = tran;
results[REFL_S] = results[REFL_P] = 1.0 - tran;

return result_val;
}
//////////
// End of example
//////////

```

This example can be found in the technical support section of www.lambdare.com, under **TracePro>Examples**. To use this OML example you must import the Surface Property within the above folder. Note that you must set up a Surface Property using the **Define|Edit Property Data|Surface Properties...** Editor if you create new DLLs. The process is the same except select for Type Coating DLL. Additionally, when you apply this property to a surface you must set its Property Orientation, including Origin (set to (0, 0, 0) in this case), Normal Direction (set to (0, 0, 1) in this case) and Up Direction (set to 0, 1, 0) in this case). See Figure 7.11 for a screen capture of the system and Figure 7.12 for the Apply Properties dialog for Filter|Variable. Figure 7.13 shows the reflection results, while Figure 7.14 shows the transmission results when a circular grid of over 30,000 rays is traced.

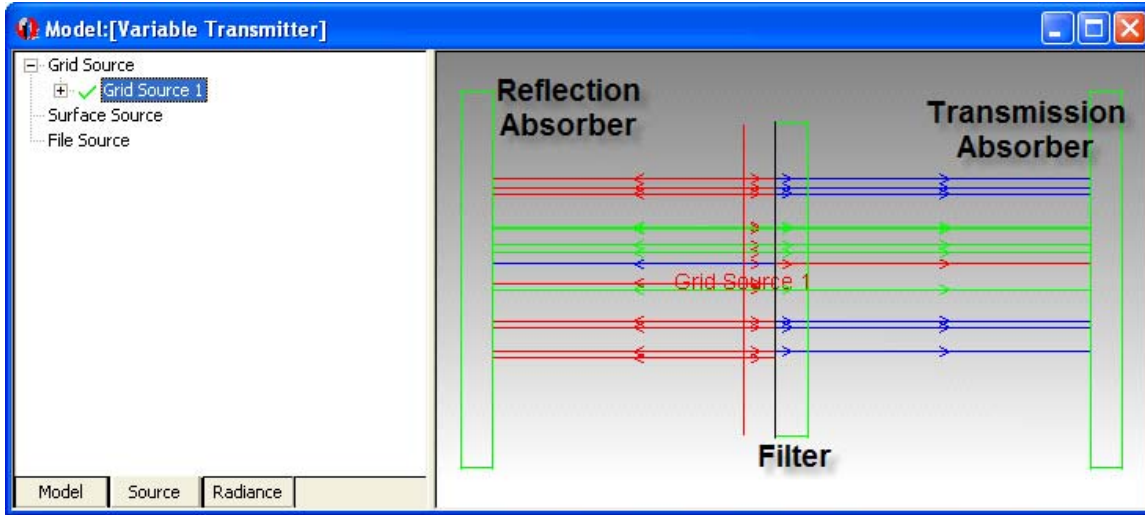

FIGURE 7.11 - Layout of the example for Enhanced Coating DLL.

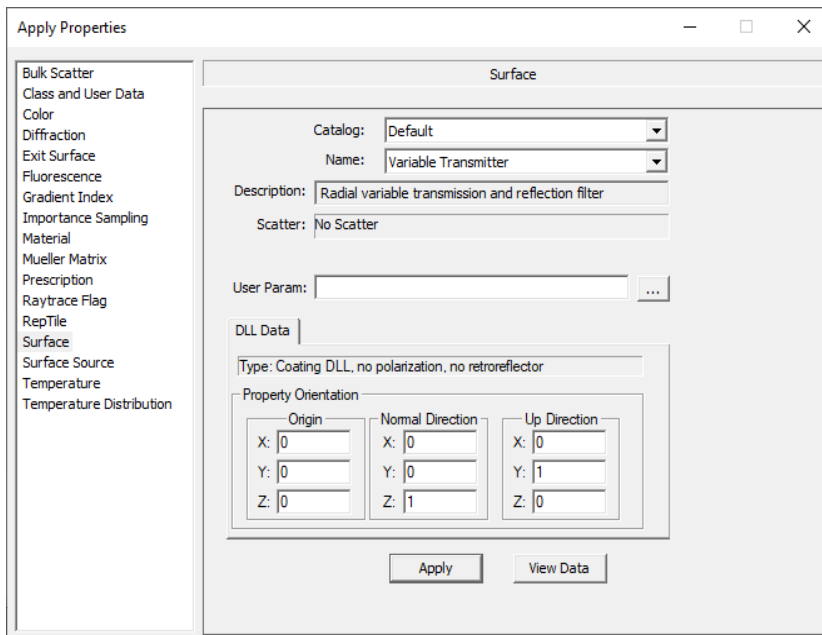

FIGURE 7.12 - Apply Properties dialog for the Filter|Variable surface.

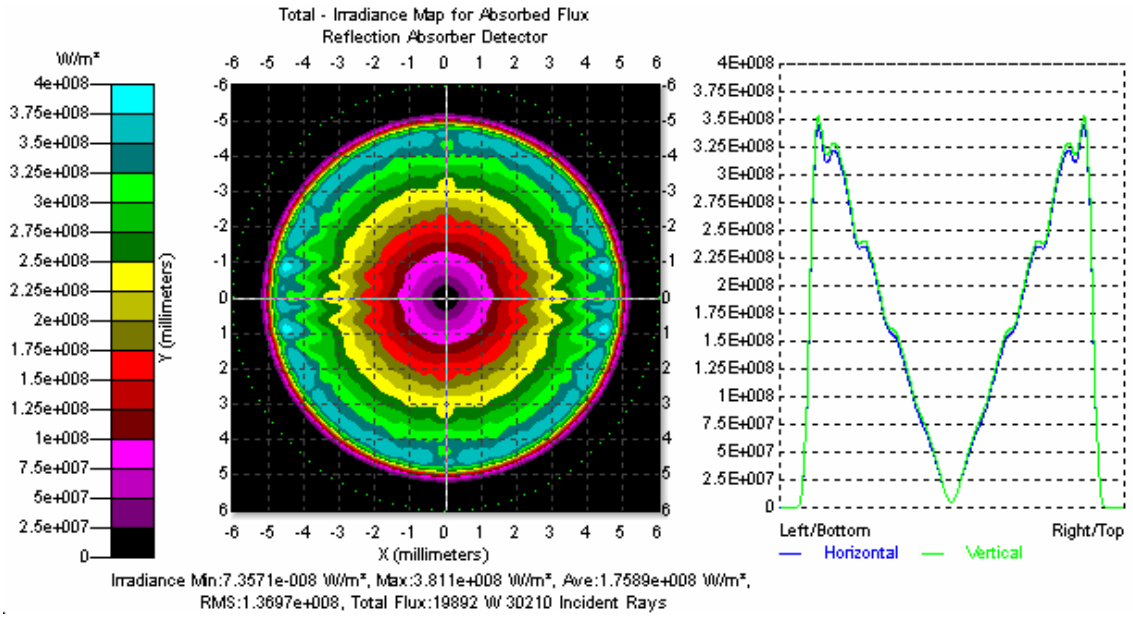

FIGURE 7.13 - Reflection results for the system of Figure 7.11.

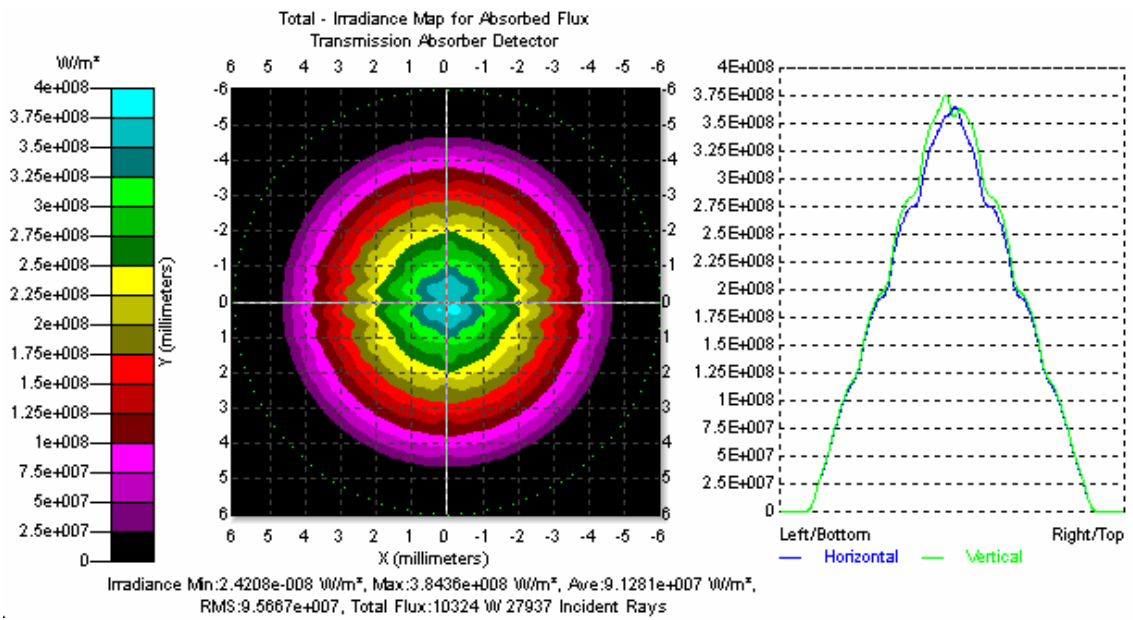

FIGURE 7.14 - Transmission results for the system of Figure 7.11.

Angles Measured in Substrate

When should I use Angles measured in Substrate?

The selection for the Reference Material when applying a Surface Property has two choices: *Angles measured in Air*, and *Angles measured in Substrate*. Most of the time when you define a Surface Property, the coefficients such as reflectance, transmittance, and BSDF are measured “in air.” This means that a flat sample is placed in a spectrometer (for reflectance or transmittance) or a scatterometer (for BSDF). When evaluating the property with a ray incident from inside the material, TracePro scales the angle according to Snell’s Law, as it must. Because properties have incident angles only up to 90 degrees, an angle of incidence inside the material beyond the critical angle of the material cannot be modeled. TracePro will extrapolate the property data in this case.

If you have data, either measured, or more typically modeled in, for example, a coating design software, you can build the property based on the angles of incidence in the material. Then when you apply the property, use the *Angles measured in Substrate* selection, being careful that the material applied the object that owns the surface is the same one that was used in defining the property.

This also applies to the BSDF values in a Table BSDF property. If you make a property for *Angles measured in Substrate* application, you must obtain BSDF data (again, from measurements or calculations) for angles inside the material.

Background and Theory

When a ray refracts into a dielectric medium, it obeys Snell’s law,

$$n_1 \sin \theta_1 = n_2 \sin \theta_2$$

This is very conveniently represented in β space as

$$n_1 \vec{\beta}_1 = n_2 \vec{\beta}_2$$

where β_1 and β_2 are the β vectors corresponding to the incident and refracted directions, respectively. The wavelength of light is shorter in a dielectric medium, $n\lambda_n = \lambda$, where λ_n is the wavelength in the medium and λ is the wavelength in vacuum. The scattering direction

$$\left| \vec{\beta} - \vec{\beta}_0 \right| = \left| \Delta \vec{\beta} \right|$$

is related to the wavelength in a way similar to the grating equation. The grating equation for a reflection grating can be written

$$\left| \Delta \vec{\beta} \right| = \frac{m\lambda}{\Lambda}$$

where Λ is the spatial wavelength of the grating grooves and values of m represent the diffracted orders. In fact, the physics for scattering of light same is the same as that for diffraction by a grating. For a polished surface, we have only the $m = 1$ order of scattered light, and we can say that

$$|\Delta\vec{\beta}| = \frac{\lambda}{\Lambda} = \lambda f$$

where Λ is the spatial wavelength of the power spectral density (PSD) of surface roughness, and $f = 1/\Lambda$ is the spatial frequency. For the same PSD, then, the scattering values $|\Delta\beta|$ are smaller by a factor of n in the medium than they are in air. For example, suppose a ray enters a dielectric medium with a slightly rough (i.e. polished) surface. The surface roughness can be characterized by a PSD as a function of frequency. Inside the material, the relation above becomes

$$|\Delta\vec{\beta}_n| = \lambda_n f = \frac{|\Delta\vec{\beta}|}{n}$$

which means that light that would scatter at a given beta (or $|\Delta\beta|$) for a frequency f inside the medium will scatter at a beta that is a factor of n smaller in air. In short, scattered light obeys Snell's law. Furthermore, the maximum spatial frequency in the PSD that can cause scattered light in air for light at normal incidence is

$$f_{\max} = \frac{1}{\lambda}$$

and in the medium the highest spatial frequency is

$$f_{\max}^n = \frac{1}{\lambda_n} = \frac{n}{\lambda} = n f_{\max}$$

Properties Measured in Air

Normally, BSDFs are measured in air from a planar substrate. This holds true for BTDFs as well as BRDFs. When curved substrates are measured, (e.g. a finished mirror) the measurement equipment is modified to account for the focusing of the surface.

Suppose we normally illuminate a planar sample, as shown in Figure 7.15, which has scattering on the first surface but no scatter on the second surface. Scattered rays that occur at beta values corresponding to spatial frequencies between f_{\max} and $n f_{\max}$ are trapped inside the substrate due to total internal reflection (TIR). If we measure the BTDF by scanning a detector on the far side of the substrate, the beta values are off by a factor of n . Specifically,

$$\beta_{\text{air}} = n\beta_n$$

where β_{air} represents values of beta measured in air and β_n those in the medium. In order to use these measurements in TracePro, we must scale the beta value by n before evaluating the BTDF. Furthermore, light scattered at β values larger than $1/n$ in the medium will not be measured. A calculation of the integrated scatter will not include this scatter, and the total scattered light will be underestimated.

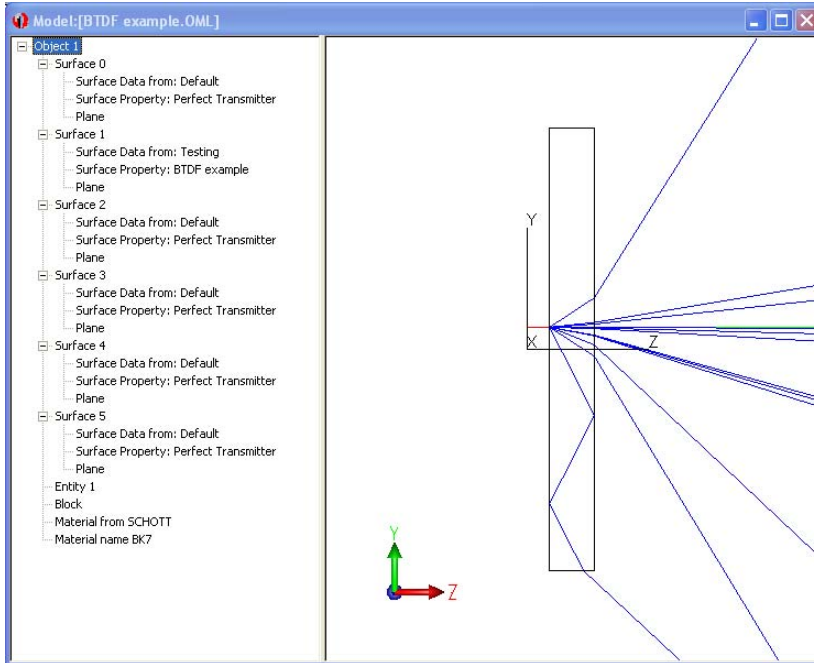

FIGURE 7.15 - Scattering from BTDF on the first surface of a planar substrate immersed in air. Rays scattered at β inside the substrate emerge at $n\beta$. Rays scattered at $\beta > 1/n$ in the substrate are trapped by TIR.

When light scatters from the first surface according to the BTDF as in Figure 7.15, the amount of flux scattered into a differential solid angle $d\Omega_n$ in the medium is

$$\Phi_s = BTDF_n \left(\left| \Delta \vec{\beta}_n \right| \right) d\Omega_n$$

From Snell's law we know that after emerging from the medium, the same scattered flux is spread through a solid $d\Omega_{air}$ where

$$d\Omega_{air} = n^2 d\Omega_n$$

This means that *the measured BTDF is lower by a factor of n^2* than the actual BTDF. Now we have all the information we need to relate the true BTDF to the BTDF measured in air from a planar substrate,

$$BTDF_n \left(\left| \Delta \vec{\beta}_n \right| \right) = n^2 BTDF_{air} \left(n \left| \Delta \vec{\beta}_n \right| \right)$$

This relation is general, i.e. it also applies to BRDF, so we can write

$$BSDF_n \left(\left| \Delta \vec{\beta}_n \right| \right) = n^2 BSDF_{air} \left(n \left| \Delta \vec{\beta}_n \right| \right)$$

Again, the relation above applies only to measurements made from a planar substrate. It is possible to construct a measurement that does not suffer from the distortion of the solid angle. Consider the construction in Figure 7.16, in which the substrate is no longer planar, but is hemispherical, with the radius of the sphere

much greater than illuminating beam diameter. Rays scattered at the planar surface are incident normal to the hemispherical surface, so the solid angle remains the same.

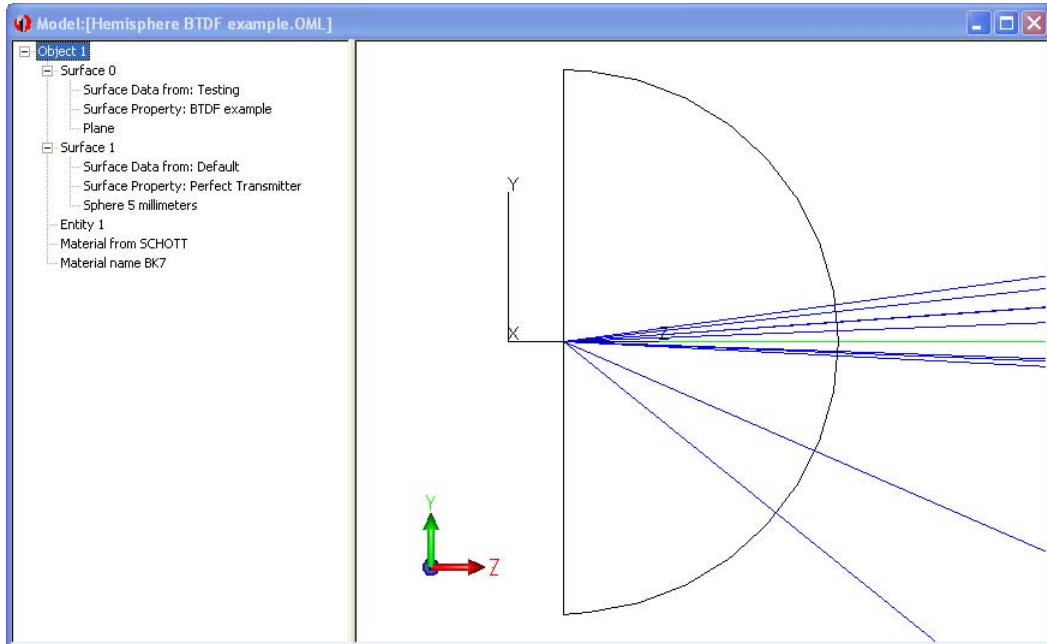

FIGURE 7.16 - One way to practically make a measurement “in the substrate” is to make a hemispherical sample.

Finally, we note that if in the measurement of the BTDF occurs on the second surface in Figure 7.16, there is no scaling needed; the measurements are being made in the medium into which the scattered light is propagating, namely air.

Surface Source Properties

TracePro has a Surface Source Property database that allows you to create and use Surface Source Properties, or use properties that are supplied with TracePro. The purpose of the Surface Source Property is to allow you to accurately model real sources, with detailed angular and spectral behavior. When you create a new Surface Source Property, you can choose from the following spectral and angular types.

Spectral Types

Rectangular
Gaussian
Solar
Table

Angular Types

Lambertian
Uniform
Gaussian
Solar
Table

You can choose any combination of spectral and angular type. The Spectral type and Angular type are independent of each other, unless you choose Table for both types. If you need to model a source that has different angular shape for different wavelengths (or different spectrum for different emission angles), then you need to create a Table Wavelength-Table Angle source. This choice will allow you to enter a separate table of emissivity versus angles for each wavelength.

Except for the Table-Table combination, the spectral and angular dependence are separable. In mathematical terms,

$$S(\lambda, \theta, \phi) = f_1(\lambda)f_2(\theta, \phi)$$

for all combinations except Table Wavelengths with Table Angles. This means that the same angular dependence applies to all wavelengths. The exception to this is the Table Wavelengths - Table Angles combination, which allows you complete flexibility to change the angular dependence with wavelength.

To use a Surface Source Property to define a surface source, select Emission Type = Source Property in the Apply Properties dialog box, Surface Source tab. Remember that the Property specifies the behavior of the source, but you can still choose what wavelengths will be traced to represent, or sample, the source. These wavelengths are entered in the Apply Properties dialog box, Surface Source tab.

Spectral types

Rectangular

To make a Rectangular Spectral Type surface property, you specify a minimum wavelength and a maximum wavelength. The emissivity is equal to the value in the table for wavelengths between the minimum and maximum, and zero otherwise.

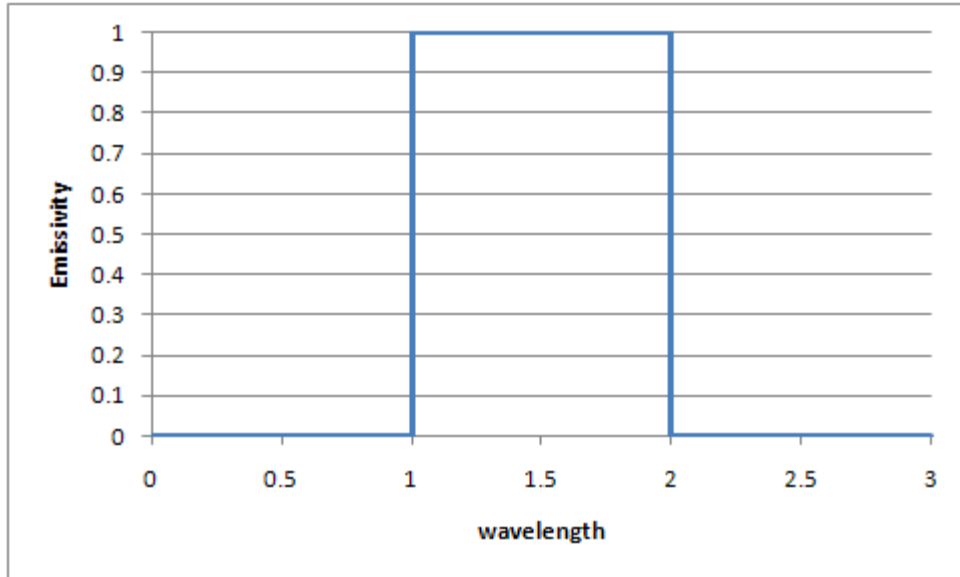

FIGURE 7.17 - Rectangular Spectrum with Min wavelength = 1, Max wavelength = 2.

Gaussian

To make a Gaussian Spectral Type surface property, you specify a Central wavelength and a $1/e^2$ half-width wavelength. The spectral emissivity has the shape

$$S(\lambda) = \exp\left(-2\left[\frac{(\lambda - \lambda_{central})}{\lambda_{\frac{1}{2}}}\right]^2\right)$$

An example Gaussian spectrum with Center wavelength = 1 and half-width = 0.1 is shown in Figure 7.18.

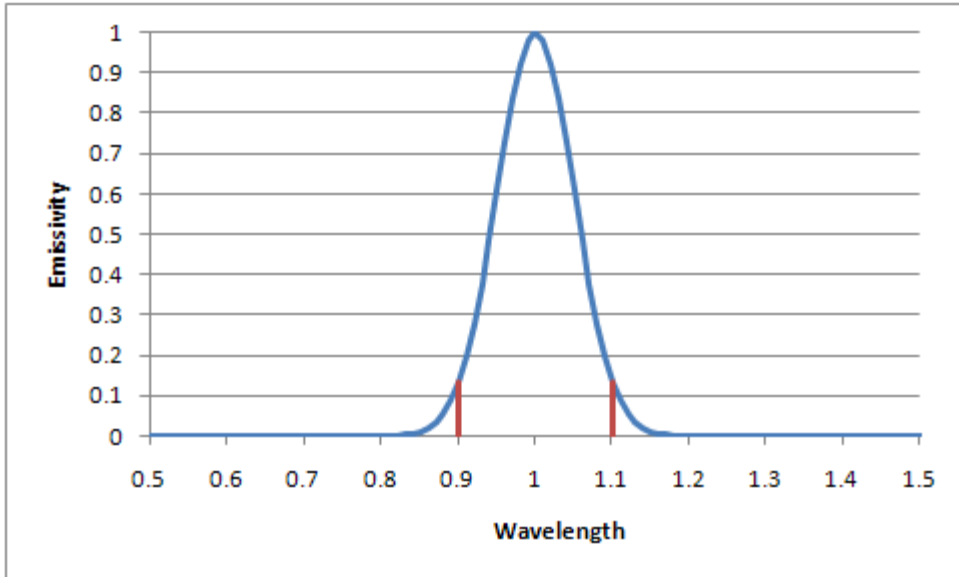

FIGURE 7.18 - Gaussian Spectrum with Center wavelength = 1 and $1/e^2$ wavelength = 0.1. The red vertical lines show the half-width wavelengths with emissivity value of $1/e^2 = 0.1353$.

Solar

The Solar Spectral Type uses a standard solar spectrum: ASTM E-490-00. It is the solar spectral irradiance incident on the Earth's upper atmosphere in SI units of $W/m^2-\mu m$. According to the standard, the total insolation irradiance is $1366.1 W/m^2$. Therefore, when you make a Solar Spectral Type property, it is a Radiometric Irradiance source with Emission = $1366.1 W/m^2$. The spectrum extends from $0.1195 \mu m$ to $1000 \mu m$. A portion of the spectrum is shown in Figure 7.19.

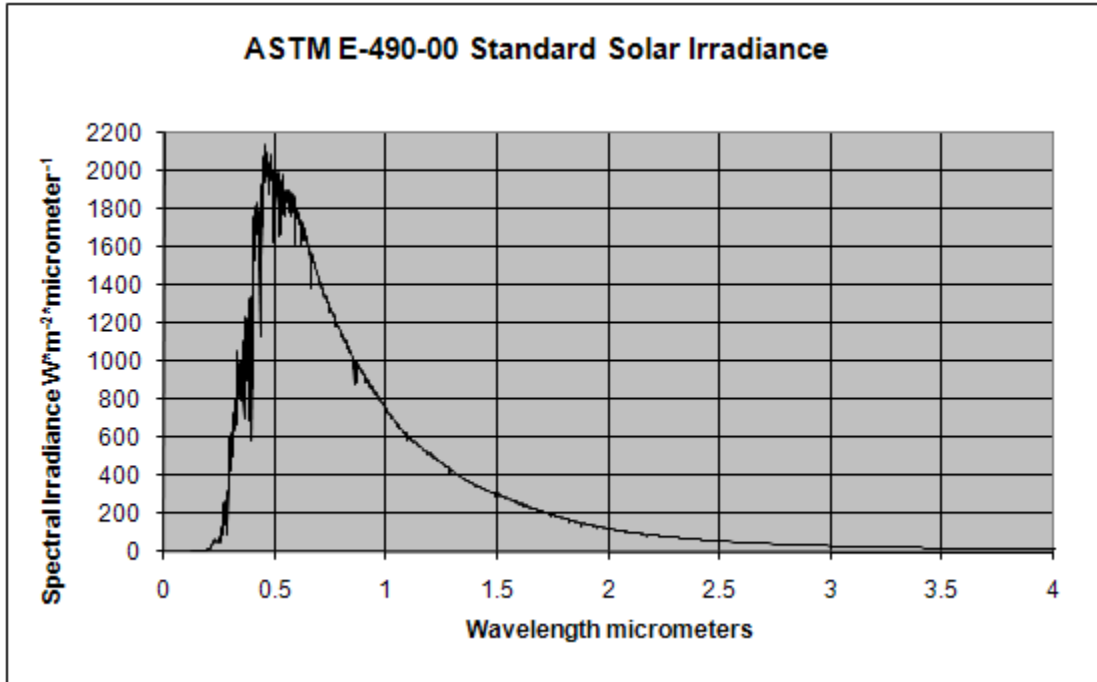

FIGURE 7.19 - A portion of the ASTM E-490-00 Solar Spectrum, from wavelength 0 to 4 μm .

Table

To make a Table Spectral Type surface property, you add wavelengths to the table using the Add button in the Data Points section of the Surface Source Property Editor. As you add new wavelengths, new rows will appear in the table, so that you can enter a different emissivity value for each wavelength. When the property is applied to a Surface Source using the Apply Properties dialog box, wavelengths entered there are used to linearly interpolate between the wavelengths in the property. Applied wavelengths that are outside the wavelengths in the property will have emissivity equal to zero.

Angular Types

Lambertian

A Lambertian Angular Type surface source property has the emissivity profile

$$E(\theta) = \cos\theta$$

where θ is the angle between the surface normal and the emission direction. The only entries required are the half angle and emission. The Lambertian pattern is truncated by a cone with the half angle you enter. The Lambertian pattern is important because an ideal blackbody source emits in a Lambertian pattern, and many real incandescent, or thermal, surface sources emit in a very nearly Lambertian pattern.

Uniform

A Uniform Angular Type surface source property does not vary with angle. The only entries required are the half angle and emission value. The pattern is truncated by a cone with the half angle you enter.

Gaussian

To make a Gaussian Angular Type surface property, you specify x and y $1/e^2$ half-width angles, in degrees. The spectral emissivity has the shape

$$S(\theta_x, \theta_y) = \cos\theta \exp\left(-2\left[\frac{\sin\theta_x}{\sin x_{1/2}}\right]^2\right) \exp\left(-2\left[\frac{\sin\theta_y}{\sin y_{1/2}}\right]^2\right)$$

where θ_x and θ_y are angles from the surface normal in the local x-z and y-z planes, and θ is the polar angle from the surface normal, defined by $\sin^2\theta = \sin^2\theta_x + \sin^2\theta_y$. When you apply a Gaussian Angle Surface Source Property to a surface source, you must specify an Up Vector to orient the emission pattern. The Up Vector specifies the local y axis, and the local z axis is along the surface normal. The local x axis completes a right-handed coordinate system. An example Gaussian Angle distribution with half-width = 30 (along one axis) is shown in Figure 7.20.

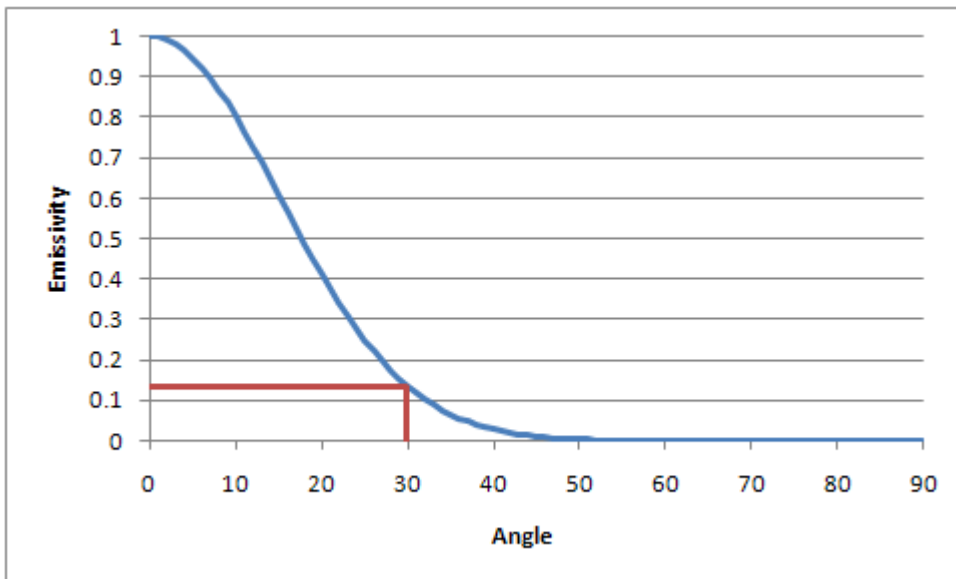

FIGURE 7.20 - Gaussian Angular Type with $1/e^2$ angle = 30 degrees. The red lines show the half-width angle with emissivity value of $\cos 30/e^2 = 0.1172$.

Solar

The Solar Angle type models the variation of the sun's brightness with angle. The "disk" of the sun is dimmer at the edge (limb darkening). The data for this angular dependence is taken from [Astrophysical Quantities](#), by C.W. Allen, The Athone

Press, University of London, Second Edition (1955). The limb darkening depends on wavelength as well.

Table

To make a Table Angular Type surface property, you add polar and azimuth angles to the table using the Add button in the Data Points section of the Surface Source Property Editor. As you add new angles, new rows will appear in the table, so that you can enter a different emissivity value for each pair of angles. When rays are generated from the Surface Source, a continuous distribution is created by linearly interpolating between the angles in the table.

Mueller Matrices and Stokes Vectors

TracePro uses the Mueller matrix-Stokes vector method of representing the polarization state of light and calculating the interaction between light and polarizing elements.

For your convenience, we have tabulated the Stokes vectors and Mueller matrices for several standard configurations.

TABLE 7.3. Stokes vectors of selected polarization states (flux = 1).

Polarization state	Stokes vector
Linear, parallel to x axis	$\begin{bmatrix} 1 \\ 1 \\ 0 \\ 0 \end{bmatrix}$
Linear, parallel to y axis	$\begin{bmatrix} 1 \\ -1 \\ 0 \\ 0 \end{bmatrix}$
Linear, 45 degrees to the x axis	$\begin{bmatrix} 1 \\ 0 \\ 1 \\ 0 \end{bmatrix}$
Linear, 135 degrees to the x axis	$\begin{bmatrix} 1 \\ 0 \\ -1 \\ 0 \end{bmatrix}$
General linear, at angle α to the x axis	$\begin{bmatrix} 1 \\ \cos 2\alpha \\ \sin 2\alpha \\ 0 \end{bmatrix}$

Circularly polarized, right-handed	$\begin{bmatrix} 1 \\ 0 \\ 0 \\ 1 \end{bmatrix}$
Circularly polarized, left-handed	$\begin{bmatrix} 1 \\ 0 \\ 0 \\ -1 \end{bmatrix}$
General elliptical, ellipse at angle λ to x axis, phase or ellipticity = ω	$\begin{bmatrix} 1 \\ \cos 2\omega \cos 2\lambda \\ \cos 2\omega \sin 2\lambda \\ \sin 2\omega \end{bmatrix}$
Unpolarized (Randomly polarized)	$\begin{bmatrix} 1 \\ 0 \\ 0 \\ 0 \end{bmatrix}$

TABLE 7.4. Mueller matrices for selected polarizing components

Component description	Mueller matrix
Linear polarizer with transmission axis along the x axis (horizontal polarizer)	$\begin{bmatrix} 0.5 & 0.5 & 0 & 0 \\ 0.5 & 0.5 & 0 & 0 \\ 0 & 0 & 0 & 0 \\ 0 & 0 & 0 & 0 \end{bmatrix}$
Linear polarizer with transmission axis along the y axis, i.e. at 90 degrees to the x axis (vertical polarizer)	$\begin{bmatrix} 0.5 & -0.5 & 0 & 0 \\ -0.5 & 0.5 & 0 & 0 \\ 0 & 0 & 0 & 0 \\ 0 & 0 & 0 & 0 \end{bmatrix}$
Linear polarizer with transmission axis at 45 degrees to the x axis	$\begin{bmatrix} 0.5 & 0 & 0.5 & 0 \\ 0 & 0 & 0 & 0 \\ 0.5 & 0 & 0.5 & 0 \\ 0 & 0 & 0 & 0 \end{bmatrix}$
Linear polarizer with transmission axis at 135 degrees to the x axis	$\begin{bmatrix} 0.5 & 0 & -0.5 & 0 \\ 0 & 0 & 0 & 0 \\ -0.5 & 0 & 0.5 & 0 \\ 0 & 0 & 0 & 0 \end{bmatrix}$

Right circular polarizer	$\begin{bmatrix} 0.5 & 0 & 0 & 0.5 \\ 0 & 0 & 0 & 0 \\ 0 & 0 & 0 & 0 \\ 0.5 & 0 & 0 & 0.5 \end{bmatrix}$
Left circular polarizer	$\begin{bmatrix} 0.5 & 0 & 0 & -0.5 \\ 0 & 0 & 0 & 0 \\ 0 & 0 & 0 & 0 \\ -0.5 & 0 & 0 & 0.5 \end{bmatrix}$
Linear quarterwave retarder with fast axis along the x axis	$\begin{bmatrix} 1 & 0 & 0 & 0 \\ 0 & 1 & 0 & 0 \\ 0 & 0 & 0 & 1 \\ 0 & 0 & -1 & 0 \end{bmatrix}$
Linear quarterwave retarder with fast axis along the y axis, i.e., at 90 degrees to the x axis	$\begin{bmatrix} 1 & 0 & 0 & 0 \\ 0 & 1 & 0 & 0 \\ 0 & 0 & 0 & -1 \\ 0 & 0 & 1 & 0 \end{bmatrix}$
Linear quarterwave retarder with fast axis at 45 degrees to the x axis	$\begin{bmatrix} 1 & 0 & 0 & 0 \\ 0 & 0 & 0 & -1 \\ 0 & 0 & 1 & 0 \\ 0 & 1 & 0 & 0 \end{bmatrix}$
Linear quarterwave retarder with fast axis at 135 degrees to the x axis	$\begin{bmatrix} 1 & 0 & 0 & 0 \\ 0 & 0 & 0 & 1 \\ 0 & 0 & 1 & 0 \\ 0 & -1 & 0 & 0 \end{bmatrix}$
Unity matrix (Does nothing)	$\begin{bmatrix} 1 & 0 & 0 & 0 \\ 0 & 1 & 0 & 0 \\ 0 & 0 & 1 & 0 \\ 0 & 0 & 0 & 1 \end{bmatrix}$

TABLE 7.4 (cont.). Mueller matrices for selected polarizing components

Component description	Mueller matrix
Linear halfwave retarder with fast axis at 0 or 90 degrees to the x axis	$\begin{bmatrix} 1 & 0 & 0 & 0 \\ 0 & 1 & 0 & 0 \\ 0 & 0 & -1 & 0 \\ 0 & 0 & 0 & -1 \end{bmatrix}$
Linear halfwave retarder with fast axis at 45 or 135 degrees to the x axis	$\begin{bmatrix} 1 & 0 & 0 & 0 \\ 0 & -1 & 0 & 0 \\ 0 & 0 & 1 & 0 \\ 0 & 0 & 0 & -1 \end{bmatrix}$
Circular halfwave retarder right- or left-handed	$\begin{bmatrix} 1 & 0 & 0 & 0 \\ 0 & -1 & 0 & 0 \\ 0 & 0 & -1 & 0 \\ 0 & 0 & 0 & 1 \end{bmatrix}$

TABLE 7.5. General Mueller matrices for selected types of components

Component description	Mueller Matrix
Compensator: introduces a phase difference of 2δ between the x and y components	$\begin{bmatrix} 1 & 0 & 0 & 0 \\ 0 & 1 & 0 & 0 \\ 0 & 0 & \cos 2\delta & -\sin 2\delta \\ 0 & 0 & \sin 2\delta & \cos 2\delta \end{bmatrix}$
Rotator: rotates the plane of polarization counterclockwise through an angle θ about the z axis	$\begin{bmatrix} 1 & 0 & 0 & 0 \\ 0 & \cos 2\theta & -\sin 2\theta & 0 \\ 0 & \sin 2\theta & \cos 2\theta & 0 \\ 0 & 0 & 0 & 1 \end{bmatrix}$
Linear polarizer with transmission axis oriented at an angle α to the x axis	$\begin{bmatrix} 0.5 & 0.5 \cos 2\alpha & 0.5 \sin 2\alpha & 0 \\ 0.5 \cos 2\alpha & 0.5 \cos^2 2\alpha & 0.5 \sin 2\alpha \cos 2\alpha & 0 \\ 0.5 \sin 2\alpha & 0.5 \sin 2\alpha \cos 2\alpha & 0.5 \sin^2 2\alpha & 0 \\ 0 & 0 & 0 & 0 \end{bmatrix}$

Bulk Scattering Standard Expert

When a ray enters an object that has bulk scattering, the ray propagates a random distance, then the direction of the ray is deviated, similar to the way rays are diffracted by an aperture in TracePro. Importance sampled rays may also be generated at your option. The ray deviation and importance sampled flux are governed by a probability distribution similar to a BSDF, but slightly different. Whereas the BSDF is defined as the scattered radiance per unit incident irradiance, the scattering distribution function or SDF is defined as the scattered intensity per unit incident flux,

$$\text{SDF} = \frac{\partial I(\hat{r})}{\partial \Phi}. \quad (7.39)$$

In addition, the SDF is independent of the direction of incidence.

Henyeey-Greenstein Phase Function

One SDF that has been implemented in TracePro is after a paper by Jacques and Wang¹ that describes scattering in biological tissue and has the form

$$\text{SDF} = p(\theta) = \frac{1 - g^2}{4\pi(1 + g^2 - 2g \cos\theta)^{3/2}}, \quad (7.40)$$

where g is called the anisotropy factor, and g can take on values between -1 and 1 . When g is positive, rays are scattered more in the forward direction, and when g is negative, they are scattered more in the backward direction. When g is zero, the scattering is isotropic, i.e. the same in all directions. Figure 7.21 shows an example scattering distribution function for $g = 0.5$.

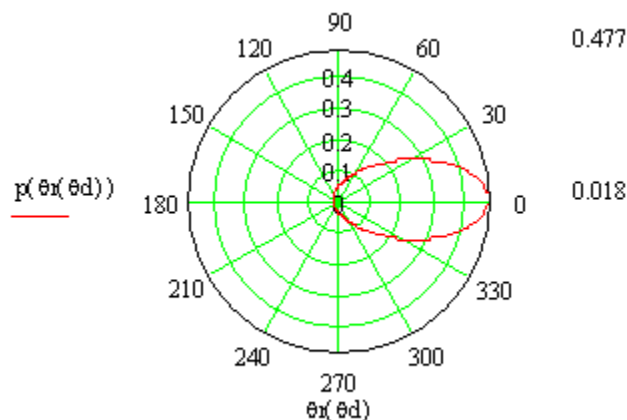

FIGURE 7.21 - Example scattering distribution with $g = 0.5$. Zero is the forward direction

1. S. L. Jacques and L.-H. Wang, "Monte Carlo modeling of light transport in tissues," in *Optical Thermal Response of Laser Irradiated Tissue*, edited by A. J. Welch and M. J. C. van Gemert (Plenum Press, New York, 1995), pp. 73-100.

Gegenbauer Phase Function

Another bulk scattering phase function offered in TracePro is the Gegenbauer^{2,3} phase function. The Henyey-Greenstein function is actually a special case of the Gegenbauer phase function. The Gegenbauer function is

$$SDF = f(\theta) = K[1 + g^2 - 2g \cos \theta]^{-(\alpha+1)} \quad (7.41)$$

where

$$K = \alpha g \frac{(1 - g^2)^{2\alpha}}{\pi[(1 + g)^{2\alpha} - (1 - g^{2\alpha})]} \quad (7.42)$$

and

$$\alpha > -1/2, |g| \leq 1 \quad (7.43)$$

The Henyey-Greenstein phase function is a special case of the Gegenbauer phase function when $\alpha = 1/2$.

Scattering Coefficient

When a ray enters a scattering medium, it propagates a random distance x governed by the probability distribution

$$P(x)dx = e^{-\mu_s x} dx, \quad (7.44)$$

where μ_s is called the scattering coefficient. The inverse of the scattering coefficient is the mean free path of the ray in the material. When a ray enters a piece of material that is thin compared to the mean free path, it is likely to pass through the material without being scattered. Conversely, if the material is thick compared to the mean free path, the ray is almost certain to scatter within the material. When a strong scattering coefficient is combined with a strong absorption coefficient, rays will be only weakly transmitted through the material.

Using Bulk Scattering in TracePro

In order to simulate bulk scattering in TracePro, select an object in which you wish scattering to occur and apply a material property using the *Apply Properties* dialog box. Then apply a bulk scattering model to the object. Finally, you can apply importance sampling to the object optionally in a way that is like surface importance sampling.

To define new bulk scattering models, open the bulk scattering model editor. Create a new scattering property and add a new wavelength entry at the desired wavelength. Enter values for g (the anisotropy factor) and μ_s , the scattering coefficient. The units for μ_s are 1/mm, (i.e. inverse millimeters). Most bulk scattering materials also have some bulk absorption, so you need to define a

-
2. L.O. Reynolds and N.J. McCormick, "Approximate two-parameter phase function for light scattering," J.O.S.A. 70, 1206 (1980).
 3. A.N. Yaroslavsky, I.V. Yaroslavsky, T. Goldbach, and H.-J. Schwarzmaier, "Influence of the Scattering Phase Function Approximation on the Optical Properties of Blood Determined from the Integrating Sphere Measurements," J. Biomed. Opt., 4, 47 (1999).

material property with the proper bulk absorption coefficient and apply it to your scattering object.

User Defined Bulk Scatter Expert

TracePro Expert provides new functionality to define phase functions for Bulk Scattering through compiled Dynamic Link Libraries (DLLs). Data from TracePro is passed into the DLL during raytrace. The DLL calculates a result, which is passed back to TracePro and used to scatter the ray. The Bulk Scatter Editor is used to select the desired DLL and to add user parameter data to control the calculations performed in the DLL. The TracePro random number function is accessible through the DLL initialization

Using Scatter DLLs

Using a bulk scatter phase function from a DLL is similar to using any existing Bulk Scatter property. The TracePro Bulk Scatter editor is opened and allows the appropriate user compiled DLL to be selected and for user parameters to be entered. The parameter data along with the DLL information is stored in the TracePro property database.

A new property entry is made by pressing the Add Bulk Scatter button in the Bulk Scatter property editor. Several scattering types are available including User DLL.

The DLL name with its location is entered in the DLL Name edit box. The Browse button may be used to navigate the computer's hard disk to locate the appropriate file. The spreadsheet rows allow user data to be added for use by the DLL during the raytrace. Each row allows six (6) coefficients with a wavelength. The data however, is passed to the DLL in its entirety and does not use the wavelength data as such.

Required DLL Functions called from TracePro

fnInitDll

Action:	Initialize DLL
Syntax:	BULK_API double fnInitDll (RAND_FN address)
Arg Types:	address RAND_FN
Returns:	double (ignored by TracePro)
Errors:	An error will be printed to the Macro Window if the function fails or does not exist in the DLL.
Description:	The Initialization function will pass in the address of the TracePro random number generator. Any other initialization may be performed done here. This routine is called after the DLL is loaded by TracePro
Limitations:	Not applicable
Example:	

```
// This initializes the DLL
BULK_API double fnInitDll(RAND_FN address)
{
    random_function = address;
    return (double) 1.0;
}
```

fnMeanFreePath

Action: Return the mean free path.
Syntax: BULK_API double **fnMeanFreePath**(double wave, double temp, double rindex, double bulkabso, int num, double *coef);
Arg Types: wave double
temp double
rindex double
bulkabso double
num integer
coef double array
Returns: double
Errors: An error will be printed to the Macro Window if the function fails or does not exist in the DLL.
Description: Calculate the mean free path as the inverse of the scattering coefficient.
Limitations: Not applicable
Example:

```
// This returns the mean free path
BULK_API double fnMeanFreePath(double wave,
                                double temp,
                                double rindex,
                                double bulkabso,
                                int num,
                                double *coef)
{
    if ( coef == NULL )
        return (double) 1.0;

    if ( coef[3] > 0 )
        return 1.0 / coef[3];
    return 1.0;
}
```

fnEvaluateBSDF

Action: Return the value of the phase function for the input polar scattering angle.
Syntax: BULK_API double **fnEvaluateBSDF**(double wave, double temp, double rindex, double bulkabso, int num, double *coef, double cos_alpha);
Arg Types: wave double
temp double
rindex double
bulkabso double
num integer
coef double array
cos_alpha double
Returns: double
Errors: An error will be printed to the Macro Window if the function fails or does not exist in the DLL.
Description: During importance sampling, TracePro must evaluate the phase function to compute the flux assigned to each importance sampled ray. This function returns the phase function evaluated in the direction corresponding to the given polar angle. TracePro passes the cosine of the polar angle as the last argument (cos_alpha).

Limitations: Not applicable

Example:

```
// Evaluate the phase function for a particular polar angle alpha.
// This is needed for computing the flux of importance sampled
// rays.
BULK_API double fnEvaluateBSDF(double wave,
                               double temp,
                               double rindex,
                               double bulkabso,
                               int num,
                               double *coef,
                               double cos_alpha)
{
double result = 0;

if ( coef == NULL )
    return (double) result;

double g = coef[2];
double g2 = g * g;
double cos_temp;

if ( (g < -1.0) || (g > 1.0) )
{
    // Error condition
    result = 0.0;
}
else if ( fabs(g) < LF_ROUNDOFF_TOL )
    result = 1.0 / (4.0 * PI);
else
{
    cos_temp = 1.0 + g2 - 2.0 * g * cos_alpha;
// There is an extra factor of 1/TWOPI to correctly
// normalize the bsdf (really sdf)
// compared to the Wang and Jacques paper. Their formula
// (eq. 14) is used only for deriving the
// polar c.d.f., because they never heard of importance
// sampling. Requiring that the integral
// of the probability distribution over a sphere is equal
// to one produces the extra factor of 1/TWOPI.
    result = ( 1.0 - g2 ) / ( TWOPI * 2.0 * pow( cos_temp, 1.5 ) );
}
return (result);
}
```

fnScatterDirection

Action: Returns the cosine of the polar scattering angle and the azimuth angle in the argument phi.
 Syntax: BULK_API double **fnScatterDirection**(double wave, double temp, double rindex, double bulkabso, int num, double *coef, double phi);
 Arg Types: wave double
 temp double
 rindex double
 bulkabso double
 num integer
 coef double array
 phi double pointer
 Returns: double, and double pointer in phi
 Errors: An error will be printed to the Macro Window if the function fails or does not exist in the DLL.
 Description: During ray tracing, the direction of a randomly scattered ray is calculated by this function. This function calculates the cosine of the polar scattering angle where a value of 1.0 is along the original ray direction and -1.0 reverses the ray direction. The azimuth scattering angle is then calculated about the ray direction and passed back to TracePro as phi.
 Limitations: Not applicable
 Example:

```
// This returns the cosine of the polar scatter alpha and the
// azimuth angle in the argument phi
BULK_API double fnScatterDirection(double wave,
                                   double temp,
                                   double rindex,
                                   double bulkabso,
                                   int num,
                                   double *coef,
                                   double *phi)
{
    double cos_theta = 1.0;

    *phi = 0.0;

    if ( coef == NULL )
        return (double) cos_theta;

    double g = coef[2];
    double g2 = g * g;
    double cos_temp;

    // The expression below is cos(theta) as a function of the
    // cumulative distribution function (c.d.f.)
    // derived from the Henyey-Greenstein phase function.
    // This expression is obtained by computing the c.d.f. as a
    // function of theta, then solving for theta.
```



```

// The c.d.f. is the definite integral over alpha from 0 to theta
of the phase function.
// To get a random value of theta, choose a random number for the
c.d.f., then evaluate theta as is done below.
if ( fabs(g) < SMALLANGLE )
    cos_theta = 2.0*frand() - 1.0;
// isotropic scattering, i.e. g = "anisotropy" coefficient
else
{
    // theta is the same as alpha in tissue scattering notes
    cos_temp = (1.0-g2) / (1.0 - g + 2.0*g*frand());
    cos_theta = (0.5/g) * ( 1.0 + g2 - ( cos_temp * cos_temp ) );
}
    // Choose a uniform random number for the azimuth (phi)
direction, as the Henyey-Greenstein phase function
// is rotationally symmetric about the direction of incidence.
*phi = frand() * TWOPI;
return (double) cos_theta;
}

```

Common Arguments passed from TracePro

wave	current raytrace wavelength
temp	current raytrace temperature
rindex	refractive index on the object as defined by the applied Material Property
bulkabso	bulk absorption for the object as defined by the applied Material Property
num	number of elements in the coef array
coef	array of user data defined in the spreadsheet area of the Bulk Scatter Editor

Each function takes the current wavelength (wave), temperature (temp), refractive index (rindex), bulk absorptance (bulkabso), coefficient count (num) and coefficient array (coef). The coefficient array has 8 elements for each count in num. The Temperature is currently passed as 0.0 for all rows.

Bulk Scattering Editor where the array elements are

```

coef[0] = temp, (First Editor Row)
coef[1] = wave,
coef[2] = Coeff 0
coef[3] = Coeff 1
coef[4] = Coeff 2
coef[5] = Coeff 3
coef[6] = Coeff 4
coef[7] = Coeff 5
coef[8] = temp, (Second Editor Row)
coef[9] = wave,
coef[10] = Coeff 0
coef[11] = Coeff 1
coef[12] = Coeff 2
coef[13] = Coeff 3

```

```
coef[14] = Coeff 4  
coef[15] = Coeff 5 and so on.
```

DLL Export Definitions

Several programming languages may be used to compile the Scatter DLL. An example using Microsoft Visual C++ is included on the CD in the Bulk Scatter Property folder and on www.lambdares.com in the TracePro Technical Support section, under Properties. Windows requires that the functions be Exported in order that TracePro may access them. A typical Exports file (DEF) is shown below.

```
LIBRARY    bulk  
  
EXPORTS  
    fnInitDll      @2  
    fnMeanFreePath@3  
    fnEvaluateBSDF@4  
    fnScatterDirection@5
```

Non-Uniform Temperature Distributions

Overview

A temperature distribution property allows for non-uniform temperature distributions over a surface. You can access it via the *Temperature Distribution* tab in the **Define | Apply Properties** dialog. The surface shapes compatible with this feature are planes and cylinders. For simple boundary shapes, the surface boundary can be used as the boundary of the distribution. These simple shapes are: rectangular (a plane with a rectangular boundary); circular (a plane with a circular boundary); and cylindrical (the curved side of a cylinder, with planar ends perpendicular to the cylinder's axis). The distribution information is stored in an ASCII file, and can be defined by: a two dimensional array of points along the surface, with bilinear interpolation between the given points; or a polynomial expression, up to the fifth order, with user-defined coefficients.

The temperature distribution, when used with a Surface Property or a Surface Source Property that has several temperatures defined, enables the property to vary with temperature spatially across the surface. During a ray-trace, the temperature is first evaluated by interpolating the temperature distribution for the ray intersection point, and then this temperature is used to interpolate Property. This can also be used, indirectly, as a way to make TracePro use a spatially-varying property. If the temperature is not important in the current analysis, it is can be effectively used as a parameter to spatially vary the property.

Distribution Types

There are two surface types – planar and cylindrical – and two ways to define temperature values along the surfaces – interpolating temperatures between defined points, or using a set of equations to relate the temperature. In addition, distributions on planar surfaces can be defined in either circular or rectangular

coordinates. This makes for six types of non-uniform temperature distributions, listed in the table below.

TABLE 7.6. Types of temperature distributions

Type	Description
0	Rectangular region, with interpolated points
1	Rectangular region, with polynomial distribution
2	Circular region, with interpolated points
3	Circular region, with polynomial distribution
4	Cylindrical region, with interpolated points
5	Cylindrical region, with polynomial distribution

Rectangular Coordinates

Rectangular distributions are defined by an X and Y coordinate system. It is easiest to talk about a three-dimensional vector space in order to visualize the arrangement of the axes. The Z axis is always normal to the surface. The origin, local X axis, and dimensions of the distribution are entered in the bottom of the dialog box, unless the surface has a rectangular boundary and you have selected *Use Surface Bounds*. In that case the origin of the system is one of the vertices of the rectangular surface. The X and Y axes are along the two edges of the rectangle adjacent to the origin, selected by following the rules for a right-handed coordinate system. This situation is illustrated below:

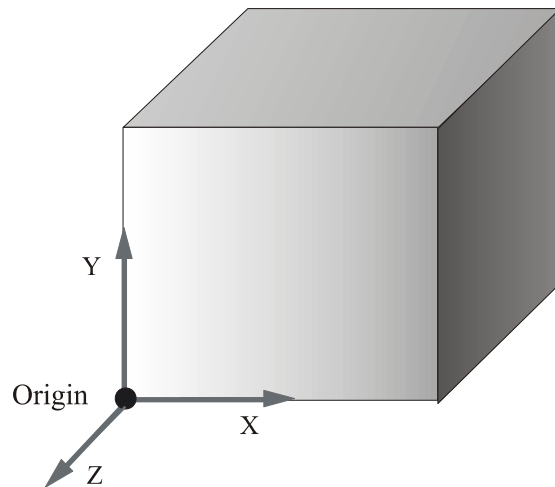

When *Use Surface Bounds* is selected, you can cycle the origin between the four vertices using the **Next Point** button. The four possible axial systems are shown below:

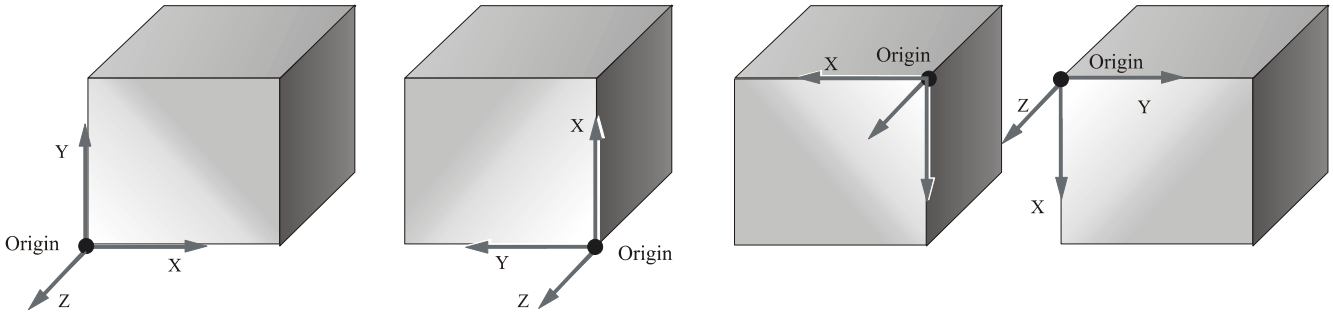

TracePro calculates all these vectors automatically once you define the origin.

Circular Coordinates

Circular distributions are defined by an R and θ polar coordinate system. The origin, local X axis, and radius of the distribution are entered in the bottom of the dialog box, unless the surface boundary is circular and you have selected *Use surface bounds*. In that case, the origin of the distribution is the center of the circular surface, and the radius is the radius of the surface. You must set the X-axis as the axis from which the angle θ is measured, in a counter-clockwise direction, as shown below:

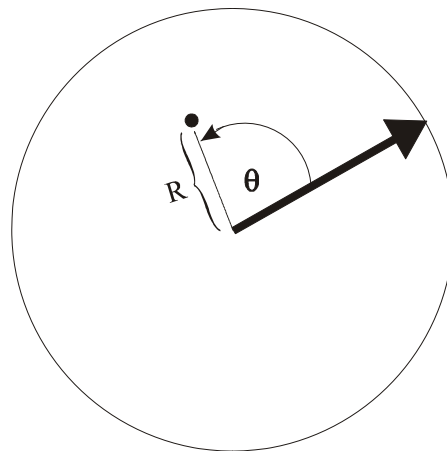

Cylindrical Coordinates

Cylindrical distributions are defined by a Z and θ coordinate system. The origin and Z length of the distribution are entered in the bottom of the dialog box, unless the surface has a simple boundary and you have selected *Use surface bounds*. In that case, the center of the distribution is the center of the cylinder on which the distribution is set. The Local Z axis is always set to be the axis of the cylinder.

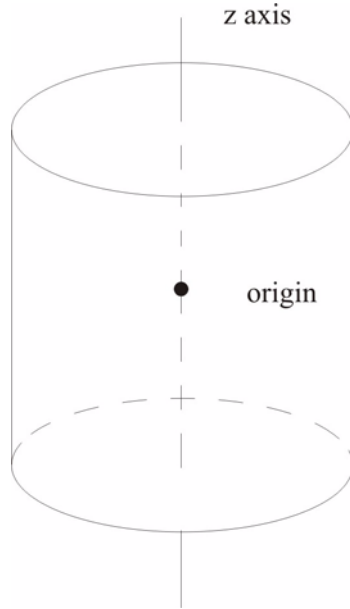

You can reverse the direction of the Z axis by clicking the **Flip Local Z** button. The θ coordinate is best visualized when viewing a cross-section of the cylinder. Set the X-axis as the axis from which θ is measured, in the same way as for Circular Coordinates. The two main differences between circular coordinates and cylindrical, when viewed in this way, are that: for the slice of the cylinder, the origin is the portion of the Z-axis cutting through the given cross-section; and that R is always set as the radius of the cylinder because we need to be on the cylinder's surface.

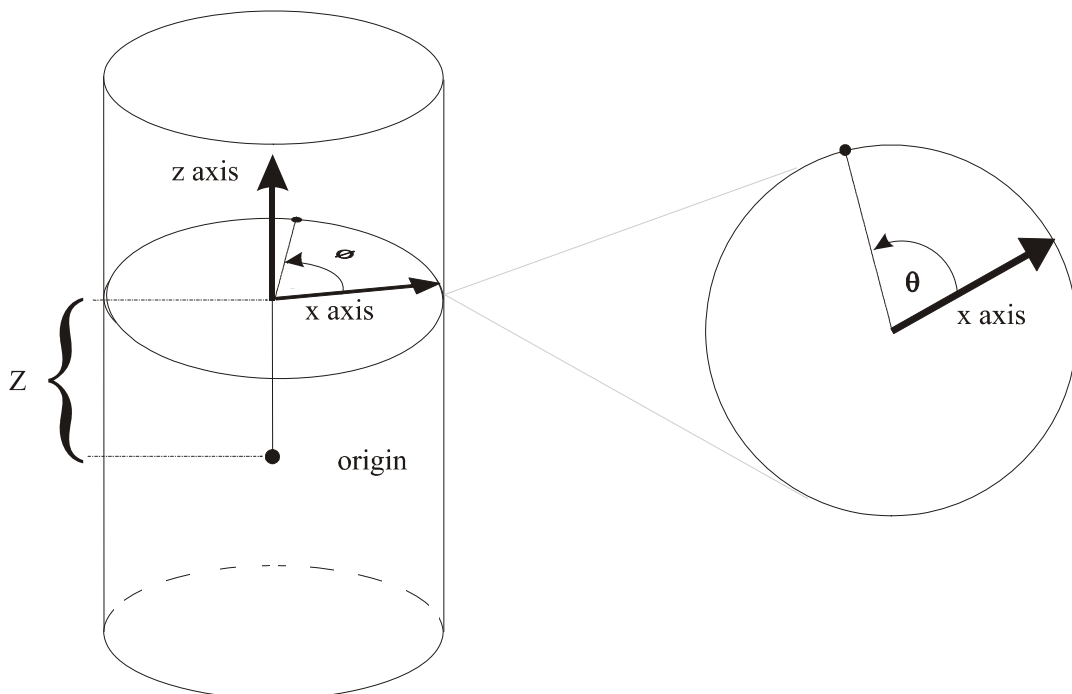

Defining Temperature Distributions

For each of the surface types listed above, you can choose to set the temperature distribution over the surface by giving TracePro a specified number of temperature values. The three shapes all have slightly different formats for input values. In general, you define the number of temperature values that will be given in each dimension and then lists the values. Examples of such commands are given below.

Additionally, you can choose to define temperatures over these surfaces by using polynomials. In this case, select the coefficients of the polynomials to be used in the approximation. The polynomial sets used for this are listed in the table below (See the end of this chapter for further information concerning polynomial distributions).

TABLE 7.7. Polynomial sets used for approximations of each dimension

Dimension (Surface Type)	Polynomial Type
X (Rectangular)	Legendre Polynomial
Y (Rectangular)	Legendre Polynomial
R, θ (Circular)	Zernike Polynomial
Z (Cylindrical)	Legendre polynomial
θ (Cylindrical)	Fourier Series

Both the options of interpolating between points and of using a polynomial distribution to delineate temperatures are performed by using data stored in ASCII files imported to TracePro through the **Temperature Distribution** tab under **Apply Properties**.

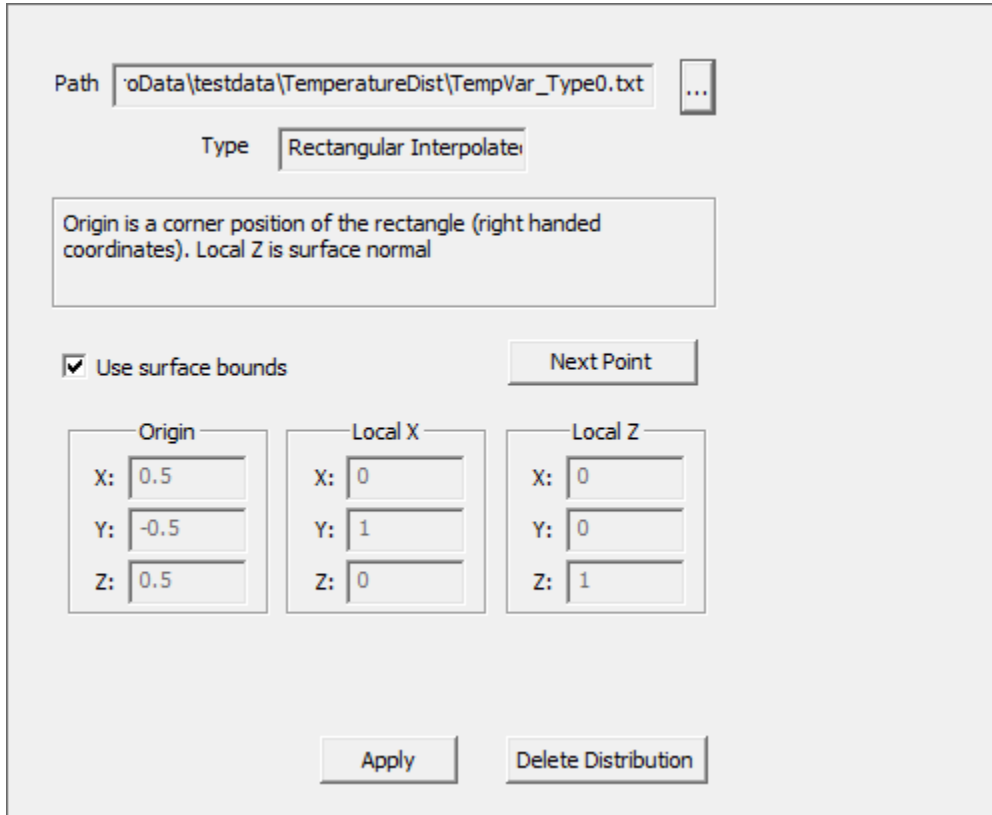

FIGURE 7.22 - Temperature Distribution Dialog for Rectangular Interpolated type with *Use surface bounds* selected.

In order to apply a property, select the desired surface, right-click and select **Properties**, then **Temperature Distribution**. Load the file that was just created, and use the **Next Point** or the **Flip Local Z** button, if necessary, to select an alternate orientation. Click *Apply* and you are finished.

Format for Temperature Distribution Storage Files

Each of the six types of non-uniform temperature distributions has its own way of storing data for TracePro. A general format for all of them is given in the following two tables:

TABLE 7.8. General File Format for Import and Export

TracePro Temperature Distribution Property Data

File Name [file name]

TracePro Release: [release version]

Database Version: [database version]

Data generated at [time and date]

Name [Property Name]

Catalog [Property Catalog]

Description [Property Description]

Type <Type>

Dim1_Coeffs_Points < Dim1_Coeffs_Points>

Dim2_Coeffs_Points < Dim2_Coeffs_Points>

User_Data 1

<Header>

<Data Set>

NOTE: For data to replace information within < > see portion of Table 4 with matching heading.

TABLE 7.9. Details for Creating Data Import and Export Files

Type	Description of Types	Dim1_Coeffs_Points	Dim2_Coeffs_Points	Header	Data Set
0	Rectangular, Interpolated Points	number of X points	number of Y points	Temperatures [Kelvin]	X*Y temperature values
1	Rectangular, Polynomial Distribution	6	6	Coefficients	6 Legendre coefficients a _{0,0} ⇒ a _{5,5}
2	Circular, Interpolated Points	number of R points	number of θ points	Temperatures [Kelvin]	R*θ temperature values
3	Circular, Polynomial Distribution	21	0	Coefficients	21 Zernike coefficients b ₀ ⇒ b ₂₀
4	Cylindrical, Interpolated Points	number of Z points	number of θ points	Temperatures [Kelvin]	Z*θ temperature values
5	Cylindrical, Polynomial Distribution	6	11	Coefficients	6 Legendre coefficients c _{0,0} ⇒ c _{5,10}

When defining a non-uniform temperature distribution property, the file name, property name, catalog, and description are at your discretion. These data inquiries are the same for all six types. The remainder of the data fields within temperature distribution import/export files are explained in detail below.

Type 0: Rectangular with Interpolated Points

For a type 0 distribution, the Dim1_Coeffs_Points is the number of columns of points on the surface, while Dim2_Coeffs_Points is the number of rows. Under the Data Set will be listed the temperature values. Let's try defining a system that looks as follows:

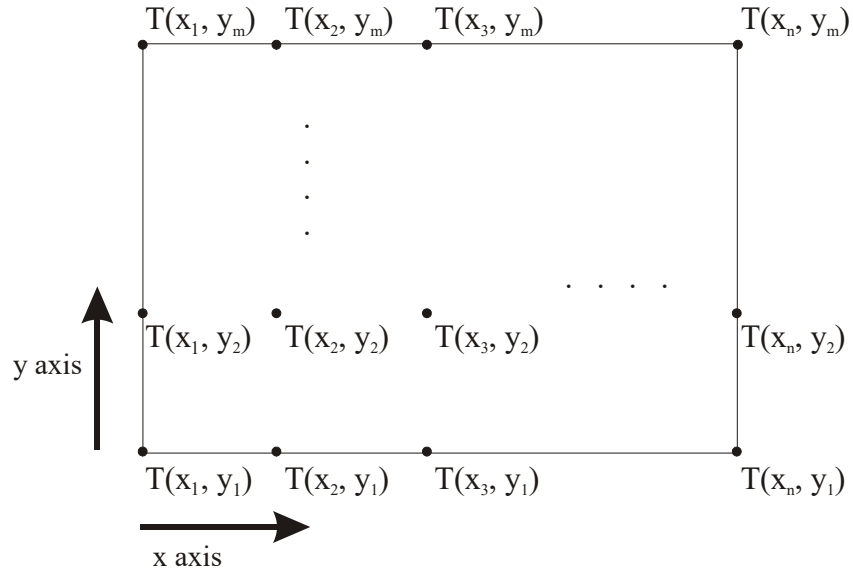

In this situation we have n columns and m rows. Entering our information into a data file would give the following:

```
TracePro Temperature Distribution Property Data
File Name C:\Tracepro\Example0.txt
TracePro Release: 2 4 0
Database Version: 2 1 0
Data generated at 09:52:39 November 16, 2001
```

```
Name          Type 0 Example
Catalog       Examples
Description
Type          0
Dim1_Coeffs_Points n
Dim2_Coeffs_Points m
User_Data     1
```

```
Temperatures [Kelvin]
T(X1,Y1)
T(X2,Y1)
T(X3,Y1)
.
.
.
```

```

T(Xn,Y1)
T(X1,Y2)
T(X2,Y2)
T(X3,Y2)
.
.
.
T(Xn,Y2)
T(X1,Y3)
.
.
.
T(Xn,Ym-1)
T(X1,Ym)
T(X2,Ym)
T(X3,Ym)
.
.
.
T(Xn-2,Ym)
T(X n-1,Ym)
T(Xn,Ym)

```

Type 1: Rectangular with Polynomial Distribution

For a type 1 file Dim1_Coeffs_Points is the number of Legendre X coefficients, 6, and Dim2_Coeffs_Points is the number of Legendre Y coefficients, 6. The Data Set is now a list of coefficients for the user-defined polynomial. An example of such a file is:

```

TracePro Temperature Distribution Property Data
File Name C:\Tracepro\Example1.txt
TracePro Release: 2 4 0
Database Version: 2 1 0
Data generated at 09:52:39 November 16, 2001

```

```

Name          Type 1 Example
Catalog       Examples
Description
Type          1
Dim1_Coeffs_Points 6
Dim2_Coeffs_Points 6
User_Data     1

```

Coefficients

a0,0
a1,0
a2,0
.
.
.
a5,0
a0,1
a1,1
a2,1
.
.
.
a5,1
a0,2
.
.
.
a5,4
a0,5
a1,5
.
.
.
a4,5
a5,5

Type 2: Circular with Interpolated Points

Type 2 situations have Dim1_Coeffs_Points as the number of different R values, and Dim2_Coeffs_Points is the number of θ values to be gone through. In other words, Dim1_Coeffs_Points is the number of concentric circles of points on the surface, while Dim2_Coeffs_Points is the number of spokes out from the circle with temperature values on them. Again, the temperature values are listed under the Data Set. A general system would look like the following:

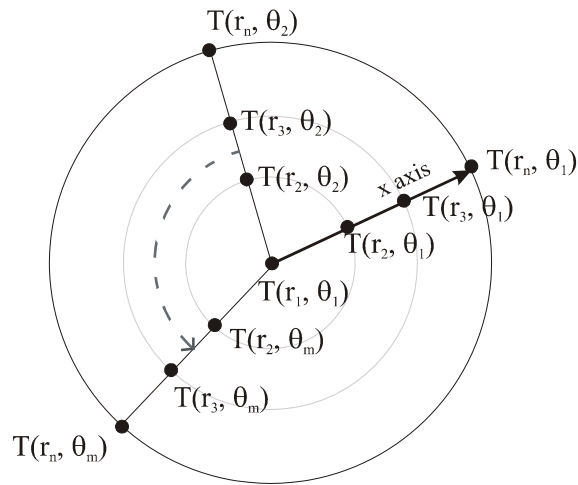

We have n concentric circles and m spokes. All points of the form $T(R_1, \theta_j)$, where $1 \leq j \leq m$, are defining the temperature at the origin. If the values given for points of this form differ, TracePro will take the average and assign it to the origin. A type 2 data file would have the following format:

```
TracePro Temperature Distribution Property Data
File Name C:\Tracepro\Example2.txt
TracePro Release: 2 4 0
Database Version: 2 1 0
Data generated at 09:52:39 November 16, 2001
```

```
Name          Type 2 Example
Catalog       Examples
Description
Type          2
Dim1_Coeffs_Points n
Dim2_Coeffs_Points m
User_Data     1
```

Temperatures [Kelvin]

$T(R_1, q_1)$

$T(R_2, q_1)$

$T(R_3, q_1)$

.

.

.

$T(R_n, q_1)$

$T(R_1, q_2)$

$T(R_2, q_2)$

$T(R_3, q_2)$

.

```

.
.
T(Rn,q2)
T(R1,q3)
.
.
.
T(Rn,qm-1)
T(R1,qm)
T(R2,qm)
T(R3,qm)
.
.
.
T(Rn-2,qm)
T(R n-1,qm)
T(Rn,qm)

```

Type 3: Circular with Polynomial Distribution

A file for a type 3 situation will have the Dim1_Coeffs_Points as the number of Zernike R, θ coefficients, 21. Dim2_Coeffs_Points is not needed in this case, and so is assigned the value of 0. The Data Set is a list of the Zernike coefficients. This file type has the format:

```

TracePro Temperature Distribution Property Data
File Name C:\Tracepro\Example3.txt
TracePro Release: 2 4 0
Database Version: 2 1 0
Data generated at 09:52:39 November 16, 2001

```

```

Name          Type 3 Example
Catalog       Examples
Description
Type          3
Dim1_Coeffs_Points 21
Dim2_Coeffs_Points 0
User_Data     1

```

```

Coefficients
b0
b1
b2
b3
b4

```

- b5
- b6
- b7
- b8
- b9
- b10
- b11
- b12
- b13
- b14
- b15
- b16
- b17
- b18
- b19
- b20

Type 4: Cylinder with Interpolated Points

For a type 4 situation the Dim1_Coeffs_Points is the number of Z values along the surface, and Dim2_Coeffs_Points is the number of θ values. Alternately, Dim1_Coeffs_Points could be viewed as the number of cross-sections of values, and Dim2_Coeffs_Points could be seen as the number of spokes of points at each cross-section. The Data Set is a list of temperature values. A type 4 situation would look as follows:

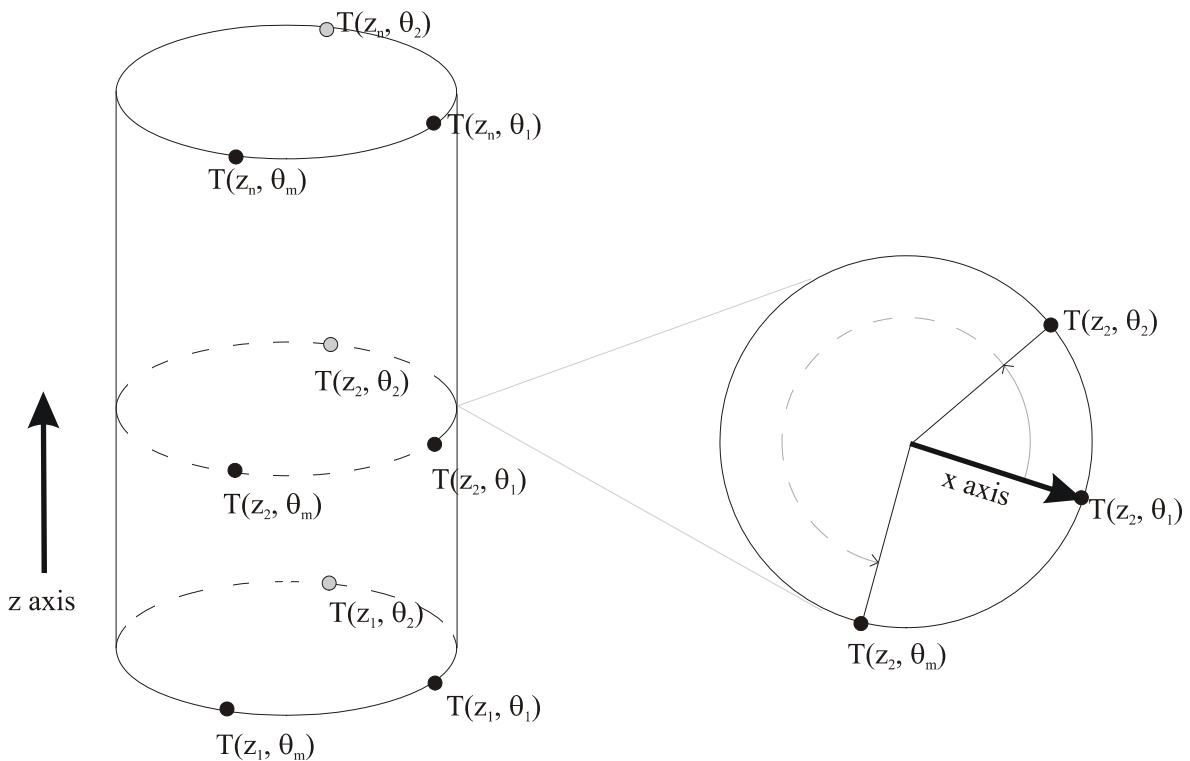

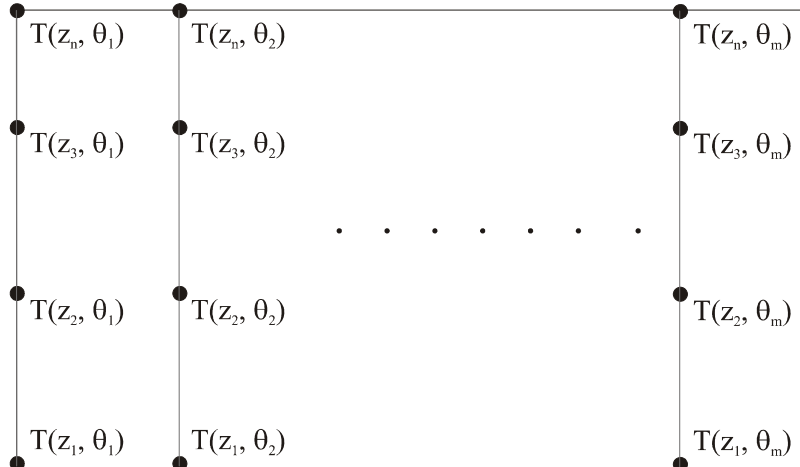

FIGURE 7.23 - Map view of cylinder's surface

This diagram shows n cross-sections and m spokes. A data file for this information would be:

```
TracePro Temperature Distribution Property Data
File Name C:\Tracepro\Example4.txt
TracePro Release: 2 4 0
Database Version: 2 1 0
Data generated at 09:52:39 November 16, 2001
```

```
Name          Type 4 Example
Catalog       Examples
Description
Type          4
Dim1_Coeffs_Points n
Dim2_Coeffs_Points m
User_Data     1
```

Temperatures [Kelvin]

```
T(Z1,q1)
T(Z2,q1)
T(Z3,q1)
.
.
.
T(Zn,q1)
T(Z1,q2)
T(Z2,q2)
T(Z3,q2)
.
```

```

.
.
T(Zn,q2)
T(Z1,q3)
.
.
.
T(Zn,qm-1)
T(Z1,qm)
T(Z2,qm)
T(Z3,qm)
.
.
.
T(Zn-2,qm)
T(Z n-1,qm)
T(Zn,qm)

```

Type 5: Cylinder with Polynomial Distribution

For a type 5 file Dim1_Coeffs_Points is the number of Legendre Z coefficients, 6, and Dim2_Coeffs_Points is the number of Fourier Series θ coefficients, 11. A list of coefficients is now in the Data Set. This file type takes the form:

```

TracePro Temperature Distribution Property Data
File Name C:\Tracepro\Example5.txt
TracePro Release: 2 4 0
Database Version: 2 1 0
Data generated at 09:52:39 November 16, 2001

```

```

Name          Type 5 Example
Catalog       Examples
Description
Type          5
Dim1_Coeffs_Points 6
Dim2_Coeffs_Points 11
User_Data     1

```

```

Coefficients
c0,0
c1,0
c2,0
.
.
.

```

c5,0
 c0,1
 c1,1
 c2,1
 .
 .
 .
 c5,1
 c0,2
 .
 .
 .
 c5,9
 c0,10
 c1,10
 .
 .
 .
 c4,10
 c5,10

Polynomial Approximations of Temperature Distributions

The following tables state the different polynomials available for approximating temperature distributions. See Table 7.7 for a summary of the types of distributions.

Polynomials use normalized coordinates. See the following sections for explanations of how these coordinate systems are applied.

Legendre polynomials - rectangular plane

Legendre polynomials are defined in normalized coordinates, in which x and y vary from -1 to 1 , i.e. the range of values is $-1 < x < 1$ and $-1 < y < 1$. This means that the reference point you define for a rectangular plane surface is located at $x=-1$, $y=-1$, the opposite corner is $x=1$, $y=1$, and the center of the rectangle is at $x=0$, $y=0$.

Zernike Polynomials - circular plane

Zernike polynomials are defined in normalized coordinates, in which $0 < r < 1$, and $0 < \theta < 2\pi$.

Therefore for a circular plane, $r=0$ at the center of the circle, $r=1$ at the edge of the circle, $\theta=0$ along the local x axis, and $\theta=\pi/2$ along the local y axis.

Legendre-Fourier polynomials - cylinder

The Zernike-Fourier functions are products of Legendre polynomials along the length of the cylinder, with elements of a Fourier series. The Legendre

polynomials are in this case a function of the z axis of standard cylindrical coordinates, with $-1 < z < 1$. The Fourier series terms are a function of theta, which varies around the circumference of the cylinder, with $0 < \theta < 2\pi$, $\theta=0$ along the local x axis, and $\theta=\pi/2$ along the local y axis.

TABLE 7.10. Legendre Polynomials

Polynomial Number	Polynomial
0	1
1	x
2	$0.5 (-1 + 3x^2)$
3	$0.5 (-3x + 5x^3)$
4	$0.125 (3 - 30x^2 + 35x^4)$
5	$0.125 (15x - 70x^3 + 63x^5)$

TABLE 7.11. Zernike Polynomials

Polynomial Number	Polynomial
0	1
1	$r \cos\theta$
2	$r \sin\theta$
3	$r^2 \cos 2\theta$
4	$2r^2 - 1$
5	$r^2 \sin 2\theta$
6	$r^3 \cos 3\theta$
7	$(3r^3 - 2r) \cos\theta$
8	$(3r^3 - 2r) \sin\theta$
9	$r^3 \sin 3\theta$
10	$r^4 \cos 4\theta$
11	$(4r^4 - 3r^2) \cos 2\theta$
12	$6r^4 - 6r^2 + 1$
13	$(4r^4 - 3r^2) \sin 2\theta$
14	$r^4 \sin 4\theta$
15	$r^5 \cos 5\theta$
16	$(5r^5 - 4r^3) \cos 3\theta$
17	$(10r^5 - 12r^3 + 3r) \cos\theta$
18	$(10r^5 - 12r^3 + 3r) \sin\theta$
19	$(5r^5 - 4r^3) \sin 3\theta$
20	$r^5 \cos 5\theta$

TABLE 7.12. Fourier Series

Term Number	Term
0	0.5
1	$\cos\theta$
2	$\sin\theta$

3	cos2θ
4	sin2θ
5	cos3θ
6	sin3θ
7	cos4θ
8	sin4θ
9	cos5θ
10	sin5θ

Rules for combining the preceding sets of functions with the user-defined coefficients are outlined in Table 7.13, and in greater detail in Table 7.14 through Table 7.16. TracePro evaluates the user-created functions in three dimensions in order to find the temperature value at any point on the surface.

TABLE 7.13. Polynomial functions for calculating temperatures

Distribution Type	Function
1	$T = \sum_{j=0} \sum_{i=0} a_{i,j} L_i(x) L_j(y)$
3	$T = \sum_{i=0} b_i Z_i(r, \theta)$
5	$T = \sum_{j=0} \sum_{i=0} c_{i,j} L_i(z) F_j(\theta)$

TABLE 7.14. Polynomial for Rectangular Surfaces

Coefficient ($a_{i,j}$)	First Legendre Polynomial ($L_i(x)$)	Second Legendre Polynomial ($L_j(y)$)
$a_{0,0}$	1	1
$a_{1,0}$	x	1
$a_{2,0}$	$[0.5 (-1 + 3x^2)]$	1
$a_{3,0}$	$[0.5 (-3x + 5x^3)]$	1
$a_{4,0}$	$[0.125 (3 - 30x^2 + 35x^4)]$	1
$a_{5,0}$	$[0.125 (15x - 70x^3 + 63x^5)]$	1
$a_{0,1}$	1	y
$a_{1,1}$	x	y
$a_{2,1}$	$[0.5 (-1 + 3x^2)]$	y
$a_{3,1}$	$[0.5 (-3x + 5x^3)]$	y
$a_{4,1}$	$[0.125 (3 - 30x^2 + 35x^4)]$	y
$a_{5,1}$	$[0.125 (15x - 70x^3 + 63x^5)]$	y
$a_{0,2}$	1	$[0.5 (-1 + 3y^2)]$
$a_{1,2}$	x	$[0.5 (-1 + 3y^2)]$
$a_{2,2}$	$[0.5 (-1 + 3x^2)]$	$[0.5 (-1 + 3y^2)]$
$a_{3,2}$	$[0.5 (-3x + 5x^3)]$	$[0.5 (-1 + 3y^2)]$
$a_{4,2}$	$[0.125 (3 - 30x^2 + 35x^4)]$	$[0.5 (-1 + 3y^2)]$
$a_{5,2}$	$[0.125 (15x - 70x^3 + 63x^5)]$	$[0.5 (-1 + 3y^2)]$
$a_{0,3}$	1	$[0.5 (-3y + 5y^3)]$
$a_{1,3}$	x	$[0.5 (-3y + 5y^3)]$
$a_{2,3}$	$[0.5 (-1 + 3x^2)]$	$[0.5 (-3y + 5y^3)]$
$a_{3,3}$	$[0.5 (-3x + 5x^3)]$	$[0.5 (-3y + 5y^3)]$
$a_{4,3}$	$[0.125 (3 - 30x^2 + 35x^4)]$	$[0.5 (-3y + 5y^3)]$
$a_{5,3}$	$[0.125 (15x - 70x^3 + 63x^5)]$	$[0.5 (-3y + 5y^3)]$
$a_{0,4}$	1	$[0.125 (3 - 30y^2 + 35y^4)]$
$a_{1,4}$	x	$[0.125 (3 - 30y^2 + 35y^4)]$
$a_{2,4}$	$[0.5 (-1 + 3x^2)]$	$[0.125 (3 - 30y^2 + 35y^4)]$
$a_{3,4}$	$[0.5 (-3x + 5x^3)]$	$[0.125 (3 - 30y^2 + 35y^4)]$
$a_{4,4}$	$[0.125 (3 - 30x^2 + 35x^4)]$	$[0.125 (3 - 30y^2 + 35y^4)]$
$a_{5,4}$	$[0.125 (15x - 70x^3 + 63x^5)]$	$[0.125 (3 - 30y^2 + 35y^4)]$
$a_{0,5}$	1	$[0.125 (15y - 70y^3 + 63y^5)]$
$a_{1,5}$	x	$[0.125 (15y - 70y^3 + 63y^5)]$
$a_{2,5}$	$[0.5 (-1 + 3x^2)]$	$[0.125 (15y - 70y^3 + 63y^5)]$
$a_{3,5}$	$[0.5 (-3x + 5x^3)]$	$[0.125 (15y - 70y^3 + 63y^5)]$

$a_{4,5}$	$[0.125 (3 - 30x^2 + 35x^4)]$	$[0.125 (15y - 70y^3 + 63y^5)]$
$a_{5,5}$	$[0.125 (15x - 70x^3 + 63x^5)]$	$[0.125 (15y - 70y^3 + 63y^5)]$

TABLE 7.15. Polynomial for Circular Surfaces

Coefficient (b_i)	Zernike Polynomial ($Z_i(r, \theta)$)
b_0	1
b_1	$(r \cos\theta)$
b_2	$(r \sin\theta)$
b_3	$(r^2 \cos 2\theta)$
b_4	$(2r^2 - 1)$
b_5	$(r^2 \sin 2\theta)$
b_6	$(r^3 \cos 3\theta)$
b_7	$[(3r^3 - 2r) \cos\theta]$
b_8	$[(3r^3 - 2r) \sin\theta]$
b_9	$(r^3 \sin 3\theta)$
b_{10}	$(r^4 \cos 4\theta)$
b_{11}	$[(4r^4 - 3r^2) \cos 2\theta]$
b_{12}	$(6r^4 - 6r^2 + 1)$
b_{13}	$[(4r^4 - 3r^2) \sin 2\theta]$
b_{14}	$(r^4 \sin 4\theta)$
b_{15}	$(r^5 \cos 5\theta)$
b_{16}	$[(5r^5 - 4r^3) \cos 3\theta]$
b_{17}	$[(10r^5 - 12r^3 + 3r) \cos\theta]$
b_{18}	$[(10r^5 - 12r^3 + 3r) \sin\theta]$
b_{19}	$[(5r^5 - 4r^3) \sin 3\theta]$
b_{20}	$(r^5 \cos 5\theta)$

TABLE 7.16. Polynomial for Cylindrical Surfaces

Coefficient ($c_{i,j}$)	Legendre Polynomial ($L_i(z)$)	Fourier Series ($F_j(\theta)$)
$c_{0,0}$	1	0.5
$c_{1,0}$	z	0.5
$c_{2,0}$	$[0.5 (-1 + 3z^2)]$	0.5
$c_{3,0}$	$[0.5 (-3z + 5z^3)]$	0.5
$c_{4,0}$	$[0.125 (3 - 30z^2 + 35z^4)]$	0.5
$c_{5,0}$	$[0.125 (15z - 70z^3 + 63z^5)]$	0.5
$c_{0,1}$	1	$\cos\theta$

c _{1,1}	z	cosθ
c _{2,1}	[0.5 (-1 + 3z ²)]	cosθ
c _{3,1}	[0.5 (-3z + 5z ³)]	cosθ
c _{4,1}	[0.125 (3 – 30z ² + 35z ⁴)]	cosθ
c _{5,1}	[0.125 (15z – 70z ³ + 63z ⁵)]	cosθ
c _{0,2}	1	sinθ
c _{1,2}	z	sinθ
c _{2,2}	[0.5 (-1 + 3z ²)]	sinθ
c _{3,2}	[0.5 (-3z + 5z ³)]	sinθ
c _{4,2}	[0.125 (3 – 30z ² + 35z ⁴)]	sinθ
c _{5,2}	[0.125 (15z – 70z ³ + 63z ⁵)]	sinθ
c _{0,3}	1	cos2θ
c _{1,3}	z	cos2θ
c _{2,3}	[0.5 (-1 + 3z ²)]	cos2θ
c _{3,3}	[0.5 (-3z + 5z ³)]	cos2θ
c _{4,3}	[0.125 (3 – 30z ² + 35z ⁴)]	cos2θ
c _{5,3}	[0.125 (15z – 70z ³ + 63z ⁵)]	cos2θ
c _{0,4}	1	sin2θ
c _{1,4}	z	sin2θ
c _{2,4}	[0.5 (-1 + 3z ²)]	sin2θ
c _{3,4}	[0.5 (-3z + 5z ³)]	sin2θ
c _{4,4}	[0.125 (3 – 30z ² + 35z ⁴)]	sin2θ
c _{5,4}	[0.125 (15z – 70z ³ + 63z ⁵)]	sin2θ
c _{0,5}	1	cos3θ
c _{1,5}	z	cos3θ
c _{2,5}	[0.5 (-1 + 3z ²)]	cos3θ
c _{3,5}	[0.5 (-3z + 5z ³)]	cos3θ
c _{4,5}	[0.125 (3 – 30z ² + 35z ⁴)]	cos3θ
c _{5,5}	[0.125 (15z – 70z ³ + 63z ⁵)]	cos3θ
c _{0,6}	1	sin3θ
c _{1,6}	z	sin3θ
c _{2,6}	[0.5 (-1 + 3z ²)]	sin3θ
c _{3,6}	[0.5 (-3z + 5z ³)]	sin3θ
c _{4,6}	[0.125 (3 – 30z ² + 35z ⁴)]	sin3θ
c _{5,6}	[0.125 (15z – 70z ³ + 63z ⁵)]	sin3θ
c _{0,7}	1	cos4θ

c _{1,7}	z	cos4θ
c _{2,7}	[0.5 (-1 + 3z ²)]	cos4θ
c _{3,7}	[0.5 (-3z + 5z ³)]	cos4θ
c _{4,7}	[0.125 (3 – 30z ² + 35z ⁴)]	cos4θ
c _{5,7}	[0.125 (15z – 70z ³ + 63z ⁵)]	cos4θ
c _{0,8}	1	sin4θ
c _{1,8}	z	sin4θ
c _{2,8}	[0.5 (-1 + 3z ²)]	sin4θ
c _{3,8}	[0.5 (-3z + 5z ³)]	sin4θ
c _{4,8}	[0.125 (3 – 30z ² + 35z ⁴)]	sin4θ
c _{5,8}	[0.125 (15z – 70z ³ + 63z ⁵)]	sin4θ
c _{0,9}	1	cos5θ
c _{1,9}	z	cos5θ
c _{2,9}	[0.5 (-1 + 3z ²)]	cos5θ
c _{3,9}	[0.5 (-3z + 5z ³)]	cos5θ
c _{4,9}	[0.125 (3 – 30z ² + 35z ⁴)]	cos5θ
c _{5,9}	[0.125 (15z – 70z ³ + 63z ⁵)]	cos5θ
c _{0,10}	1	sin5θ
c _{1,10}	z	sin5θ
c _{2,10}	[0.5 (-1 + 3z ²)]	sin5θ
c _{3,10}	[0.5 (-3z + 5z ³)]	sin5θ
c _{4,10}	[0.125 (3 – 30z ² + 35z ⁴)]	sin5θ
c _{5,10}	[0.125 (15z – 70z ³ + 63z ⁵)]	sin5θ

Interpretation of Polar Iso-Candela Plots

Iso-candela intensity plots (i.e., W/sr or cd depending on the units) can cause confusion to users. This section addresses such potential confusion by providing an example that illustrates what happens when you project a hemispherical distribution onto a plane. Figure 7.24 shows the sphere over which the intensity distribution should be viewed, and then how it is projected to the base plane of this hemisphere. For this simple illustration the projected solid angle is given by

$$d\Omega = d\omega \cos\theta \tag{7.45}$$

where θ is the angle with respect to the normal axis, $d\omega$ is the solid angle, and $d\Omega$ is the projected solid angle. In TracePro the angle θ is the one with respect to the Normal (as defined in **Analysis | Candela Plot Options**). Each of the rays is binned within constant solid angle bins (i.e., they span the same surface area on the unit hemisphere). Additionally, for Polar Iso-Candela plots, individually each

ray is corrected for the nonlinear projection from this hemisphere to the plane. This nonlinear projection is due to the constant angular spacing in the radial direction on polar iso-candela plots, as shown in Figure 7.25 and Figure 7.26 (i.e., the annular pie slices do not have constant areas as function of the radiant angle). Thus, two rays at different angles that are in the same bin with the same flux will contribute different amounts of intensity (cd or W/sr) to this bin. If you save the Polar Iso-candela data (**File | Save As...** of type *.txt), the nonlinear projection is also saved.

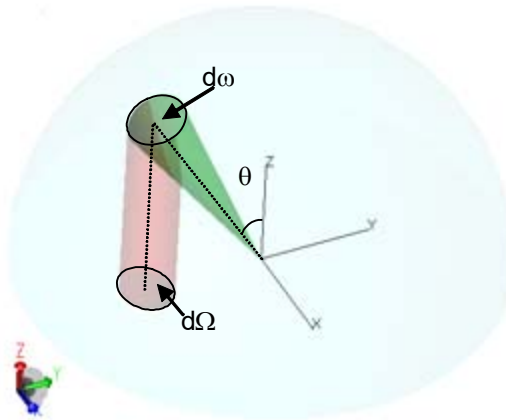

FIGURE 7.24 - Depiction of solid angle projection from a hemisphere to the base plane of the hemisphere.

To illustrate this, consider the case shown in Figure 7.25, there are grid sources comprised each of single rays. Grid 1 has a ray in the x-z plane at an angle of 63.426° to the z axis. Grid 2 has a ray in the x-z plane at an angle of 64.537° to the z axis. Figure 7.26 shows the iso-candela plots (**Analysis | Candela Plots | Polar Iso-Candela**) for (a) Grid 1 and (b) Grid 2. Note the difference in the maximum candela values, which arises due to the nonlinear projection. Polar iso-candela plots in direction cosine values do not suffer from this projection effect since the $\cos(\theta)$ value in See Equation 7.45 on page 7.90 is simply the axial plot dimension. However such plots are currently not available in TracePro.

Finally, one can rotate the plot normal, by, for example, placing the Grid 1 ray at the pole. This is done by changing **Analysis | Candela Plot Options > Orientation and Rays** tab X to 0.8944 and Z to 0.4472. Figure 36 shows the results for (a) Grid 1 and (b) Grid 2.

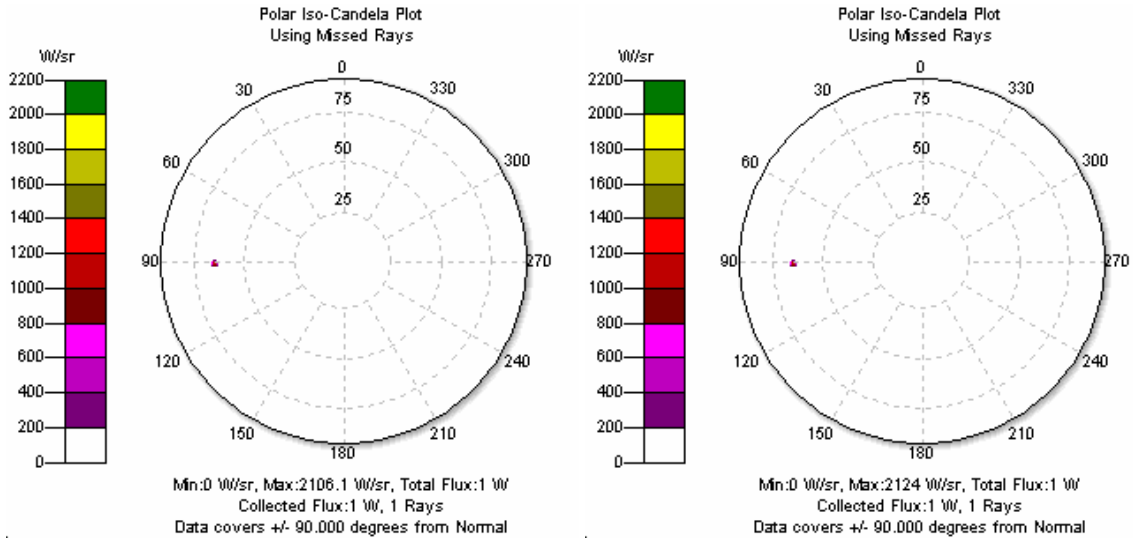

FIGURE 7.25 - Polar Iso-Candela Plots for Grids (a) 1 and (b) 2, Normal = (0, 0, 1).

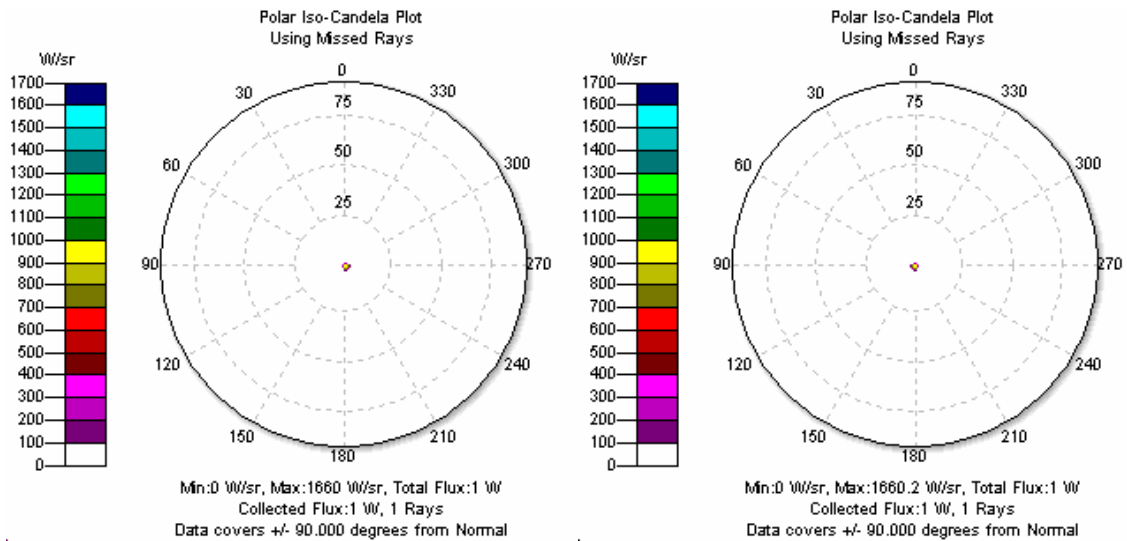

FIGURE 7.26 - Polar Iso-Candela Plots for Grids (a) 1 and (b) 2, Normal = (0.8944, 0, 0.4472).

Property Import/Export Formats

Material Property Format

The format includes 18 header lines, which must be present in the file followed by the actual property data. Tabs or spaces may be used to separate data (tabs are more convenient when working with spreadsheets) and properties exported from TracePro will use tabs.

The tables below describe the format of these files, but the easiest way to learn how to use the Import/Export format is to export a material property and view it yourself in text format. You may wish to treat the following information as a reference, rather than a tutorial.

Line #	Description	Read for Import	Format
1	File Header	Yes	TracePro Material Property Data
2	Database File Name	Ignored	File Name E:\TraceProData\tracepro.mdb
3	TracePro Version	Ignored	TracePro Version: 2 1 0
4	Database Version	Yes	Database Version: 2 1 0
5	Data file was generated	Ignored	Data generated at 09:32:31 May 06, 2000
6	Blank line	Ignored	
7	Property Name	Yes	Name <i>name</i>
8	Property Catalog	Yes	Catalog <i>name</i> (If the catalog does not exist, it will be created during the import)
9	Property Description	Yes	Description <i>text</i>
10	Military Specification	Yes	MILSPEC <i>text</i>
11	Start of Wavelength Range	Yes	WaveStart <i>number</i> Wavelength in microns
12	End of Wavelength Range	Yes	WaveStart <i>number</i> Wavelength in microns

13	Equation Type	Yes	<i>code</i> 1. Interpolation from table 2. Schott polynomial 3. Sellmeier (1) polynomial 4. Extended Schott polynomial 5. Herzberger polynomial 6. Conrady polynomial 7. Sellmeier (2) polynomial 8. Sellmeier (3) polynomial 9. Sellmeier (4) polynomial 10. Handbook of Optics (1) polynomial 11. Handbook of Optics (2) polynomial
14	User Data flag	Yes	<i>User flag</i> 1. Lambda Research Data (Read Only) 2. User added data (Read/Write)
15	Coefficients	Yes	This set the units of the absorption column to alpha, for internal transmittance, or k for imaginary refractive index. Bulk_is_Alpha sets units to alpha Bulk_is_K sets units to k
16-17	Polynomial Coefficients	Yes	Two rows of five numbers. Zero if table interpolation is used.
18	Column Headers	Yes	Temperature Wavelength Index Absorption
19+	Wavelength Data	Yes	Multiple rows of data: Temperature Wavelength Index Absorption
Last	Save Data	Optional	SAVE-DATA This may be placed between multiple properties and is used by the Tools Database Import command

Surface Property Format

The format includes 15 header lines, which must be present in the file followed by the property data. Tabs or spaces may be used to separate data (tabs are more convenient when working with spreadsheets) and properties exported from TracePro will use tabs. The tables below describe the format of these files, but the easiest way to learn how to use the Import/Export format is to export a surface property that is already defined and view it yourself in text format. This will allow you to see exactly what data TracePro exports with each property. Practice by modifying the property name and using the **Tools|Database|Import** command to add it to your database under the new name.

Line #	Description	Read for Import	Format
1	File Header	Yes	TracePro Surface Property Data
2	Database File Name	Ignored	File Name E:\TraceProData\tracepro.db
3	TracePro Version	Ignored	TracePro Version n n n
4	Database Version	Yes	Database Version n n n
5	Data file was generated	Ignored	Data generated at hh:mm:ss Month dd, yyyy
6	Blank line	Ignored	
7	Property Name	Yes	Name <i>name</i>
8	Property Description	Yes	Description <i>text</i>
9	Coating Data Flag	Yes	Coating <i>flag</i> flag values: 1. no coating data, Fresnel (specular terms are 0.0) 2. tabular data 3. stack with Stack Name Coating 2 <i>MgF Layer</i> 4. grating type with grating spacing Coating 3 12 5. Coating DLL type 6. (not used) 7. Direction-sensitive property
10	Scatter type	Yes	Scatter type 0 No scatter 1 ABg 2 Elliptical ABg 3 Elliptical Gaussian 4 Table 5 Asymmetric Table
11	Interaction flag	Yes	Interaction <i>flag</i> flag values: 1. normal surface interaction 2. retroreflector
12	Polarization flag	Yes	Polarization <i>flag</i> flag 1. non-polarizing property (S and P terms are equal) 2. polarizing data

13	User Data flag	Yes	User <i>flag</i> flag values: 1. Lambda Research Data (Read Only) 2. User data (Read/Write)
14	Solve Code	Yes	Solve code <i>code</i> values: <None> no solve performed ABSORP solve for absorptance SPECREFL solve for reflectance SPECTRANS solve for transmittance BRDF solve for BRDF BTDF solve for BTDF
15	Blank Line	Ignored	
16	Side 1 Data (optional)	Yes	Side1_Data If present, the data that follows is for Side 1 of a Direction-sensitive property
16 or 17	Column Headers	Only Temperature is Ignored	Temperature (followed by additional column headers)
17+ or 18+	Surface Data	Yes	17 columns of real numbers
17+ or 18+	Grating Data Line	Yes	AnisotropicGratingData If this line exists the following data will be applied to the grating orders.
17+ or 18+	Grating Data	Yes	eight columns of real numbers
17+ or 18+	Table BSDF Data Line	Yes	Table_BSDF_Data If this line exists the following data will be applied to the BRDF and BTDF values
17+ or 18+	Table BSDF Data	Yes	eight columns of real numbers

19+ or 20+	Side 2 Data (optional)	Yes	Side2_Data If present, the data that follows is for Side 2 of a Direction-sensitive property
Last	Save Data	Optional	SAVE-DATA This may be placed between multiple properties and is used by the Tools Database Import command

Surface Property Data Columns

The Surface Property Data is placed in 17 columns separated by spaces or tabs. The example shown is for Elliptical ABg Model BSDF data.

Column #	Name	Description
1	Temperature	Kelvin
2	Wavelength	Microns
3	Inc Angle	Angle of incidence
4	Azi Angle	Azimuthal Angle
5	Abso_S	Specular Absorptance for S polarization
6	Abso_P	Specular Absorptance for P polarization
7	Refl_S	Specular Reflectance for S polarization
8	Refl_P	Specular Reflectance for P polarization
9	Tran_S	Specular Transmittance for S polarization
10	Tran_P	Specular Transmittance for S polarization
11	PhaseRefl	Phase change for Transmittance
12	PhaseTran	Phase change for Transmittance
13	BRDF_A	A coefficient of BRDF
14	BRDF_B	B coefficient of BRDF
15	BRDF_By	B coefficient of BRDF
16	BRDF_g	g coefficient of BRDF
17	BRDF_gy	g coefficient of BRDF
18	BTDF_A	A coefficient of BTDF
19	BTDF_B	B coefficient of BTDF
20	BTDF_By	B coefficient of BTDF
21	BTDF_g	g coefficient of BTDF
22	BTDF_gy	g coefficient of BTDF

Grating Data Columns

The Grating Data follows in a separate table beginning with the header *AnisotropicGratingData*. Grating Data is organized in eight columns separated by tabs.

Column #	Name	Description
1	Temperature	Kelvin
2	Wavelength	Microns
3	Angle	Angle of incidence (degrees)
4	Order	Grating Order
5	Eff_Refl_S	Efficiency for Reflectance in the S polarization
6	Eff_Refl_P	Efficiency for Reflectance in the P polarization
7	Eff_Tran_S	Efficiency for Transmittance in the S polarization
8	Eff_Tran_P	Efficiency for Transmittance in the P polarization

Table BSDF Data Columns

Table BSDF Data follows in a separate table with header *Table_BSDF_Data*. Table BSDF is organized in eight columns separated by tabs.

Column #	Name	Description
1	Temperature	Kelvin
2	Wavelength	Microns
3	IncAngle	Polar angle of incidence (degrees)
4	AziAngle	Azimuthal angle of incidence (degrees)
5	ScatterBeta	The length of the $\beta-\beta_0$ vector (unitless)
6	ScatterAzimuth	The azimuthal angle of the $\beta-\beta_0$ vector (degrees)
7	BRDF	The value of the BRDF at the parameters (1/sr)
8	BTDF	The value of the BTDF at the parameters (1/sr)

Stack Property Format

The format includes 12 header lines, which must be present in the file followed by the property data. Tabs or spaces may be used to separate data (tabs are more convenient when working with spreadsheets) and properties exported from TracePro will use tabs. The tables below describe the format of these files, but the easiest way to learn how to use the Import/Export format is to export a stack property that is already defined and view it yourself in text format. This will allow you to see exactly what data TracePro exports with each property. Practice by modifying the property name and using the `Tools | Database | Import` command to add it to your database under the new name.

Line #	Description	Read for Import	Format
1	File Header	Yes	TracePro Stack Property Data

2	Database File Name	Ignored	File Name E:\TraceProData\tracepro.mdb
3	TracePro Version	Ignored	TracePro Version: 2 1 0
4	Database Version	Yes	Database Version: 2 1 0
5	Data file was generated	Ignored	Data generated at 09:32:31 May 06, 2000
6	Blank line	Ignored	
7	Property Name	Yes	Name <i>name</i>
8	Property Description	Yes	Description <i>text</i>
9	Type Flag	Ignored	
10	User Data flag	Yes	User <i>flag</i> 1. Lambda Research Data (Read Only) 2. User added data (Read/Write)
11	Blank Line	Ignored	
12	Column Headers	Ignored	Thickness(um) CatalogName
13+	Data	Yes	Column 1. Thickness (um) 2. Material Catalog 3. Material Name
Last	Save Data	Optional	SAVE-DATA This may be placed between multiple properties and is used by the Tools Database Import command

Gradient Index Property Format

The format includes 12 header lines, which must be present in the file followed by the property data. Tabs or spaces may be used to separate data (tabs are more convenient when working with spreadsheets) and properties exported from TracePro will use tabs. The tables below describe the format of these files, but the easiest way to learn how to use the Import/Export format is to export a gradient index property that is already defined and view it yourself in text format. This will allow you to see exactly what data TracePro exports with each property. Practice by modifying the property name and using the **Tools|Database|Import** command to add it to your database under the new name.

Line #	Description	Read for Import	Format
1	File Header	Yes	TracePro Gradient Index Property Data

2	Database File Name	Ignored	File Name E:\TraceProData\tracepro.mdb
3	TracePro Version	Ignored	TracePro Version: 2 1 0
4	Database Version	Yes	Database Version: 2 1 0
5	Data file was generated	Ignored	Data generated at 09:32:31 May 06, 2000
6	Blank line	Ignored	
7	Property Name	Yes	Name <i>name</i>
8	Property Description	Yes	Description <i>text</i>
9	Type Flag	Yes	Type <i>flag</i> Flag values <ol style="list-style-type: none"> 1. Axial-Radial gradient 2. Axial-Elliptical gradient 3. Axial-Sinusoidal-Radial gradient 4. Axial-Tapered-Radial gradient 5. SELFOC gradient 6. Wood Lens gradient 7. Spherical gradient 8. Fisheye Lens gradient 9. Luneburg Lens gradient 10. GRADIUM (Buchdahl) gradient 11. GRADIUM (Sellmeier) gradient
10	User Data flag	Yes	User <i>flag</i> <i>flag</i> <ol style="list-style-type: none"> 1. Lambda Research Data (Read Only) 2. User added data (Read/Write)
11	Blank Line	Ignored	
12	Column Headers	Only Temperature is Ignored	Temperature (followed by additional column headers)

13+	Data	Yes	18 columns of real numbers for properties not of type GRADIUM OR... 32 columns of real numbers for properties of type GRADIUM (Buchdahl) OR... 64 columns of real numbers for properties of type GRADIUM (Sellmeier)
Last	Save Data	Optional	SAVE-DATA This may be placed between multiple properties and is used by the Tools Database Import command

Gradient Index Data Columns (non-GRADIUM types)

The Gradient Index data for non-GRADIUM types is placed in 18 columns separated by spaces or tabs.

Column #	Name	Description	Used By
1	Temperature	Degrees C	(not currently used)
2	Wavelength	Microns	<ul style="list-style-type: none"> • Axial-Radial gradient • Axial-Elliptical gradient • Axial-Sinusoidal-Radial gradient • Axial-Tapered-Radial gradient • SELFOC gradient • Wood Lens gradient • Spherical gradient • Fisheye Lens gradient • Luneburg Lens gradient
3	nz1	Axial coefficient	<ul style="list-style-type: none"> • Axial-Radial gradient • Axial-Elliptical gradient • Axial-Sinusoidal-Radial gradient • Axial-Tapered-Radial gradient
4	nz2	Axial coefficient	<ul style="list-style-type: none"> • Axial-Radial gradient • Axial-Elliptical gradient • Axial-Sinusoidal-Radial gradient • Axial-Tapered-Radial gradient
5	nz3	Axial coefficient	<ul style="list-style-type: none"> • Axial-Radial gradient • Axial-Elliptical gradient • Axial-Sinusoidal-Radial gradient • Axial-Tapered-Radial gradient
6	nz4	Axial coefficient	<ul style="list-style-type: none"> • Axial-Radial gradient • Axial-Elliptical gradient • Axial-Sinusoidal-Radial gradient • Axial-Tapered-Radial gradient

7	nr1	Radial coefficient	<ul style="list-style-type: none"> • Axial-Radial gradient • Axial-Elliptical gradient • Axial-Sinusoidal-Radial gradient • Axial-Tapered-Radial gradient • SELFOC gradient • Wood Lens gradient • Spherical gradient • Fisheye Lens gradient • Luneburg Lens gradient
8	nr2	Radial coefficient	<ul style="list-style-type: none"> • Axial-Radial gradient • Axial-Elliptical gradient • Axial-Sinusoidal-Radial gradient • Axial-Tapered-Radial gradient • SELFOC gradient • Spherical gradient
9	nr3	Radial coefficient	<ul style="list-style-type: none"> • Axial-Radial gradient • Axial-Elliptical gradient • Axial-Sinusoidal-Radial gradient • Axial-Tapered-Radial gradient • SELFOC gradient • Spherical gradient
10	nr4	Radial coefficient	<ul style="list-style-type: none"> • Axial-Radial gradient • Axial-Elliptical gradient • Axial-Sinusoidal-Radial gradient • Axial-Tapered-Radial gradient • SELFOC gradient • Spherical gradient
11	nrx	Elliptical radial coefficient	<ul style="list-style-type: none"> • Axial-Elliptical gradient
12	nry	Elliptical radial coefficient	<ul style="list-style-type: none"> • Axial-Elliptical gradient
13	sva	Sinusoidal radial coefficient	<ul style="list-style-type: none"> • Axial-Sinusoidal-Radial gradient
14	svp	Sinusoidal radial coefficient	<ul style="list-style-type: none"> • Axial-Sinusoidal-Radial gradient
15	svf	Sinusoidal radial coefficient	<ul style="list-style-type: none"> • Axial-Sinusoidal-Radial gradient
16	tas	Tapered radial coefficient	<ul style="list-style-type: none"> • Axial-Tapered-Radial gradient
17	tao	Tapered radial coefficient	<ul style="list-style-type: none"> • Axial-Tapered-Radial gradient
18	sgc	Spherical coefficient	<ul style="list-style-type: none"> • Spherical gradient • Fisheye Lens gradient • Luneburg Lens gradient

Gradient Index Data Columns (GRADIUM (Buchdahl) type)

The Gradient Index data for the GRADIUM (Buchdahl) type is placed in 32 columns separated by spaces or tabs

Column #	Name	Description	Used By
1	Temperature	Degrees C	(not currently used)
2	gww	Reference wave-length in microns	GRADIUM (Buchdahl) gradient
3	gmz	Blank thickness	GRADIUM (Buchdahl) gradient
4	goz	Offset into blank	GRADIUM (Buchdahl) gradient
5	gnz0	0th order profile coefficient	GRADIUM (Buchdahl) gradient
6	gnz1	1st order profile coefficient	GRADIUM (Buchdahl) gradient
7	gnz2	2nd order profile coefficient	GRADIUM (Buchdahl) gradient
8	gnz3	3rd order profile coefficient	GRADIUM (Buchdahl) gradient
9	gnz4	4th order profile coefficient	GRADIUM (Buchdahl) gradient
10	gnz5	5th order profile coefficient	GRADIUM (Buchdahl) gradient
11	gnz6	6th order profile coefficient	GRADIUM (Buchdahl) gradient
12	gnz7	7th order profile coefficient	GRADIUM (Buchdahl) gradient
13	gnz8	8th order profile coefficient	GRADIUM (Buchdahl) gradient
14	gnz9	9th order profile coefficient	GRADIUM (Buchdahl) gradient
15	gnz10	10th order profile coefficient	GRADIUM (Buchdahl) gradient
16	gnz11	11th order profile coefficient	GRADIUM (Buchdahl) gradient
17	gra1	Buchdahl chromatic coefficient	GRADIUM (Buchdahl) gradient
18	grb1	Buchdahl chromatic coefficient	GRADIUM (Buchdahl) gradient
19	grc1	Buchdahl chromatic coefficient	GRADIUM (Buchdahl) gradient
20	grd1	Buchdahl chromatic coefficient	GRADIUM (Buchdahl) gradient
21	gra2	Buchdahl chromatic coefficient	GRADIUM (Buchdahl) gradient
22	grb2	Buchdahl chromatic coefficient	GRADIUM (Buchdahl) gradient
23	grc2	Buchdahl chromatic coefficient	GRADIUM (Buchdahl) gradient
24	grd2	Buchdahl chromatic coefficient	GRADIUM (Buchdahl) gradient

25	gra3	Buchdahl chromatic coefficient	GRADIUM (Buchdahl) gradient
26	grb3	Buchdahl chromatic coefficient	GRADIUM (Buchdahl) gradient
27	grc3	Buchdahl chromatic coefficient	GRADIUM (Buchdahl) gradient
28	grd3	Buchdahl chromatic coefficient	GRADIUM (Buchdahl) gradient
29	gra4	Buchdahl chromatic coefficient	GRADIUM (Buchdahl) gradient
30	grb4	Buchdahl chromatic coefficient	GRADIUM (Buchdahl) gradient
31	grc4	Buchdahl chromatic coefficient	GRADIUM (Buchdahl) gradient
32	grd4	Buchdahl chromatic coefficient	GRADIUM (Buchdahl) gradient

Gradient Index Data Columns (GRADIUM (Sellmeier) type)

The Gradient Index data for the GRADIUM (Sellmeier) type is placed in 64 columns separated by spaces or tabs

Column #	Name	Description	Used By
1	Temperature	Degrees C	(not currently used)
2	gww	Reference wavelength in microns	GRADIUM (Sellmeier) gradient
3	gmz	Blank thickness	GRADIUM (Sellmeier) gradient
4	goz	Offset into blank	GRADIUM (Sellmeier) gradient
5	gnz0	0th order profile coefficient	GRADIUM (Sellmeier) gradient
6	gnz1	1st order profile coefficient	GRADIUM (Sellmeier) gradient
7	gnz2	2nd order profile coefficient	GRADIUM (Sellmeier) gradient
8	gnz3	3rd order profile coefficient	GRADIUM (Sellmeier) gradient
9	gnz4	4th order profile coefficient	GRADIUM (Sellmeier) gradient
10	gnz5	5th order profile coefficient	GRADIUM (Sellmeier) gradient
11	gnz6	6th order profile coefficient	GRADIUM (Sellmeier) gradient
12	gnz7	7th order profile coefficient	GRADIUM (Sellmeier) gradient
13	gnz8	8th order profile coefficient	GRADIUM (Sellmeier) gradient

14	gnz9	9th order profile coefficient	GRADIUM (Sellmeier) gradient
15	gnz10	10th order profile coefficient	GRADIUM (Sellmeier) gradient
16	gnz11	11th order profile coefficient	GRADIUM (Sellmeier) gradient
17-24	K'_11, K'_12, ... , K'_18	K'1x Sellmeier chromatic coefficients	GRADIUM (Sellmeier) gradient
25-32	K'_21, K'_22, ... , K'_28	K'2x Sellmeier chromatic coefficients	GRADIUM (Sellmeier) gradient
33-40	K'_31, K'_32, ... , K'_38	K'3x Sellmeier chromatic coefficients	GRADIUM (Sellmeier) gradient
41-48	L_11, L_12, ... , L_18	L1x Sellmeier chromatic coefficients	GRADIUM (Sellmeier) gradient
49-56	L_21, L_22, ... , L_28	L2x Sellmeier chromatic coefficients	GRADIUM (Sellmeier) gradient
57-64	L_31, L_32, ... , L_38	L3x Sellmeier chromatic coefficients	GRADIUM (Sellmeier) gradient

Bulk Scatter Property Format

The format includes 12 header lines, which must be present in the file followed by the actual property data. Tabs or spaces may be used to separate data (tabs are more convenient when working with spreadsheets) and properties exported from TracePro will use tabs.

The tables below describe the format of these files, but the easiest way to learn how to use the Import/Export format is to export a bulk scatter property and view it yourself in text format. You may wish to treat the following information as a reference, rather than a tutorial.

Line #	Description	Read for Import	Format
1	File Header	Yes	TracePro Bulk Scattering Property Data
2	Database File Name	Ignored	File Name E:\TraceProData\tracepro.mdb
3	TracePro Version	Ignored	TracePro Version: 2 1 0
4	Database Version	Yes	Database Version: 2 1 0
5	Data file was generated	Ignored	Data generated at 09:32:31 May 06, 2000

6	Blank line	Ignored	
7	Property Name	Yes	Name text
8	Property Description	Yes	Description text
9	User Data flag	Yes	User <i>flag</i> <i>flag</i> 1. Lambda Research Data (Read Only) 2. User added data (Read/Write)
10	Type	Ignored	
11	Blank line	Ignored	
12	Column Headers	Ignored	Temperature Wavelength Coef 0 Coef 1 Coef 2 Coef 3 Coef 4 Coef 5
13+	Scatter data	Yes	Temperature Wavelength and 5 coefficients Coefficient 1. Anisotropy (g) 2. Scattering (1/mm) 3. Alpha (Gegenbauer Model) 4. unused (in V2.1) 5. unused (in V2.1)
Last	Save Data	Optional	SAVE-DATA This may be placed between multiple properties and is used by the Tools Database Import command

Fluorescence Property Format

The format includes 16 header lines, which must be present in the file followed by the property data. Tabs or spaces may be used to separate data (tabs are more convenient when working with spreadsheets) and properties exported from TracePro will use tabs. The tables below describe the format of these files, but the easiest way to learn how to use the Import/Export format is to export a property that is already defined and view it yourself in text format. This will allow you to see exactly what data TracePro exports with each property. Practice by modifying the property name and using the **Tools|Database|Import** command to add it to your database under the new name.

Line #	Description	Read for Import	Format
1	File Header	Yes	TracePro Bulk Fluorescence Property Data
2	Database File Name	Ignored	File Name E:\TraceProData\tracepro.mdb
3	TracePro Version	Ignored	TracePro Version: 4 0 0

4	Database Version	Yes	Database Version: 3 3 0
5	Date file was generated	Ignored	Data generated at 09:32:31 May 06, 2006
6	Blank line	Ignored	
7	Property Name	Yes	Name <i>name</i>
8	Property Description	Yes	Description <i>text</i>
9	Type Flag	Ignored	
10	User Data Flag	Yes	User <i>flag</i> <i>flag</i> 1. Lambda Research Data (Read Only) 2. User added data (Read/Write)
11	Blank Line	Ignored	
12	Peak_Exinction	Yes	Peak Extinction value.
13	Conversion_Efficiency	Yes	Conversion Efficiency value
14	Blank Line	Ignored	
15	Column Headers	Ignored	Temperature ExcitationWavelength RelativeAbsorption RelativeExcitation
16	Column Headers	Ignored	Temperature EmissionWavelength RelativeEmission
17+	Data	Yes	Column (First Excitation Data) 1. Temperature 2. Excitation Wavelength 3. Relative Absorption 4. Relative Excitation Column (Second Emission Data) 1. Temperature 2. Emission Wavelength 3. Relative Emission
Last	Save Data	Optional	SAVE-DATA This may be placed between multiple properties and is used by the Tools Data-base Import command

Surface Source Property Format

The format includes 21 header lines, which must be present in the file, followed by the property data. Tabs or spaces may be used to separate data (tabs are more

convenient when working with spreadsheets) and properties exported from TracePro will use tabs. The tables below describe the format of these files, but the easiest way to learn how to use the Import/Export format is to export a property that is already defined and view it yourself in text format. This will allow you to see exactly what data TracePro exports with each property. Practice by modifying the property name and using the **Tools | Database | Import** command to add it to your database under the new name.

Line #	Description	Read for Import	Format
1	File Header	Yes	TracePro Bulk Fluorescence Property Data
2	Database File Name	Ignored	File Name E:\TraceProData\tracepro.mdb
3	TracePro Version	Ignored	TracePro Version: 5 0 0
4	Database Version	Yes	Database Version: 3 3 0
5	Date file was generated	Ignored	Data generated at 09:32:31 May 06, 2006
6	Blank line	Ignored	
7	Property Name	Yes	Name <i>name</i>
8	Property Catalog	Yes	Catalog <i>catalog</i>
9	Property Description	Yes	Description <i>text</i>
10	User Data Flag	Yes	User <i>flag</i> <i>flag</i> 1. Lambda Research Data (Read Only) 2. User added data (Read/Write)
11	Spectral Type	Yes	0 = Rectangular 1 = Gaussian 2 = Solar 3 = Table
12	Angular Type	Yes	0 = Lambertian 1 = Uniform 2 = Gaussian 3 = Solar 4 = Table
13	Units	Yes	0 = Radiometric 1 = Photometric
14	Quantity	Yes	0 = Irradiance/Illuminance 1 = Flux
15	Emission	Yes	Total emission of the source

16	Wavelength1	Yes	Min wavelength (Rectangular) Center wavelength (Gaussian)
17	Wavelength2	Yes	Max wavelength (Rectangular) 1/e ² half-width (Gaussian)
18	Angle1	Yes	Conical angle (Lambertian and Uniform) x-direction 1/e ² half-width (Gaussian)
19	Angle2	Yes	y-direction 1/e ² half-width (Gaussian)
20	Blank	Ignored	
21	Column Headers	Yes	Temperature Wavelength Polar Angle Azimuth Angle Emissivity
12+	Data	Yes	Column 1. Temperature 2. Wavelength 3. Polar Angle 4. Azimuth Angle 5. Emissivity
Last	Save Data	Optional	SAVE-DATA This may be placed between multiple properties and is used by the Tools Database Import command

RepTile Property Format

The format includes 12 header lines, which must be present in the file followed by the property data. Tabs or spaces may be used to separate data (tabs are more convenient when working with spreadsheets) and properties exported from TracePro will use tabs. The tables below describe the format of these files, but the easiest way to learn how to use the Import/Export format is to export a gradient index property that is already defined and view it yourself in text format. This will allow you to see exactly what data TracePro exports with each property. Practice by modifying the property name and using the **Tools|Database|Import** command to add it to your database under the new name.

Line #	Description	Read for Import	Format
1	File Header	Yes	TracePro RepTile Property Data
2	Database File Name	Ignored	File Name C:\Documents and Settings\username\Application Data\Lambda Research Corporation\TracePro\tracepro.db
3	TracePro Version	Ignored	TracePro Version: 4 1 1
4	Database Version	Yes	Database Version: 3 3 0

5	Data file was generated	Ignored	Data generated at 17:28:43 June 29, 2007
6	Blank line	Ignored	
7	Property Name	Yes	Name <i>name</i>
8	Property Description	Yes	Description <i>text</i>
9	Geometry Type	Yes	Geometry_Type <i>type</i> 0. None 1. Fresnel 2. Cone 3. Sphere 4. Hip Roof 5. Cube 6. Prism 7. Rounded Prism 8. Ellipsoid 9. Log 10. Enhanced Prism 11. Flattened Cone 12. Pointed Cone 14. Block 15. Chiseled Log 16. Torus 17. Asphere 18. Polygon 19. Pyramid 20. Circular Hip Roof
10	Tile Type	Yes	Tile_Type <i>type</i> 0. None 1. Rings 2. Rectangle 3. Stagger 4. Hexagonal
11	Vary Row type	Yes	Vary_Rows <i>type</i> 0. Constant 1. Vary by Row or Ring 2. Parameterized 3. Texture File
12	Bump type	Yes	Bump_Type <i>type</i> 0. Bump 1. Hole 2. Mixed (Texture) 3. Inverted (Texture)

13	X Width	Yes	Width_X <i>value</i>
14	Y Width	Yes	Width_Y <i>value</i>
15	Draft Angle	Yes	Angle <i>value</i>
16	User Data flag	Yes	User <i>flag</i>
			0. Lambda Research Data (Read Only)
			1. User added data (Read/Write)
11	Blank Line	Ignored	
12	Column Headers	Ignored	Varies by Geometry Type
13+	Data	Yes	Column Data
Last	Save Data	Optional	SAVE-DATA
			This may be placed between multiple properties and is used by the Tools Database Import command

Texture File Format

The following RepTile geometry types can be used in a Texture file:

- Sphere
- Cone
- Hip Roof
- Ellipsoids
- Enhanced Prism
- Log
- Flattened Cone
- Pointed Cone
- DMD Mirror
- Block
- Chiseled Log
- Torus
- Polygon
- Pyramid
- Circular Hip Roof

The full (x, y, z) rotation for Log geometry allows logs to be holes and to be at oblique angles to the base plane. This adaptability allows for undercut on the base plane. Undercut means there is a void (i.e., air gap) between successive regions of the object's volume in the direction of the base plane surface normal. While this configuration is realizable, the manufacture, especially with small replicated geometry (e.g., backlit display panel) is prohibitively expensive. Thus, it is left to you to ensure that any potential undercut is desired. Simply said, there is no checking within TracePro to warn about potential undercut.

Additionally, Texture Files and thus Textured RepTile Properties can have a mixture of the geometry types. This allows for the inclusion of different geometry

types applied to a single surface in a TracePro model. Also, in the next section, Mixed Bump and Hole RepTiles, these Textured RepTile Properties can concurrently contain both holes and bumps. Textured RepTile allows for great control in not only the position and size of the features, but it also allows control of the shape and orientation.

In the next three subsections the characteristics of the Texture File are provided:

- Texture File syntax,
- Textured RepTile Geometry type values, and
- Parameter designations for each Geometry type

Texture File Syntax

The syntax for a Texture File is shown below with detailed descriptions in Table 7.17. The parameter items inside < > indicate data that must be supplied by the user within the Texture File.

```
RepTile Texture File
Filename:<Filename>
Date:<Date>
Version:<VersionNumber>
Texture Type:<TextureType>
```

```
Texture Features
<Type1><BumpSign1><Param11><Param12><Param13>...<Param1M>
.
.
.
<TypeN><BumpSignN><ParamN1><ParamN2><ParamN3>...<ParamNM>
```

TABLE 7.17. Texture File Format

Line #	Parameter	Description	Format
1	File Header	RepTile Texture File	String
2	Filename	Filename of the current file. The standard file type is of type *.txt. There is a space after the colon.	String
3	Date	The date the file was created or last modified. Not important for operation, but allows the user to maintain some level of version control. There is a space after the colon.	String
4	VersionNumber	The version number of this file for control of future updates to RepTile Texture Files. Currently Version 1.0. There is a space after the colon.	Double
5	TextureType	The Feature Geometry Type for the Texture Features contained within the file. See Table 7.18 for the allowed values. There is a space after the colon.	Integer
6+	Data	For the following there are N (= number of Features) instances per file. The # designation in the first column parameter list indicates the feature number.	
	Type#	This is the Feature Geometry type for the individual Feature. See Table 7.18 for more details	Integer
	BumpSign#	This is the bump (= 1) or hole (= -1) for the individual Feature.	Integer
	Param#@	This is parameter @ for Feature #, where the values for @ are dependent on the Type# and are detailed in Table 7.19.	Double

Textured RepTile Geometry Type Values

The five types of Textured RepTile shapes have a numeric designator as the first number for each Data line within the Texture File. In Table 7.17 this Geometry Type value is listed as Type#. Table 7.18 provides the integer for each Geometry Type. If a Texture File is of one Geometry Type, Line 5 in the Texture File (see Table 1) should indicate such. If a Texture File contains a hybrid of several Geometry Types, then the value of 0 should be used for TextureType in the Texture File.

TABLE 7.18. Textured RepTile File geometry type values.

Geometry Type	Value	Description
Hybrid	0	Only used for Line 5 (i.e., TextureType) in the Texture File. This value indicates that the file contains multiple Geometry Types.
Cone	2	As per Standard RepTile
Sphere	3	As per Standard RepTile
Hip Roof	4	As per Standard RepTile
Ellipsoid	8	As per Standard RepTile
Log	9	As per Standard RepTile
Enhanced Prism	10	As per Standard RepTile
Flattened Cone	11	As per Standard RepTile
Pointed Cone	12	As per Standard RepTile
DMD Mirror	13	As per Standard RepTile
Block	14	As per Standard RepTile
Chiseled Log	15	As per Standard RepTile
Torus	16	As per Standard RepTile
Asphere	17	As per Standard RepTile
Polygon	18	As per Standard RepTile
Pyramid	19	As per Standard RepTile
Circular Hip Roof	20	As per Standard RepTile

Parameter Designations for each Geometry Type

As indicated in Table 1 there are several parameters that describe an individual Feature of a designated Geometry Type. The number of parameters is dependent on the Geometry Type. Table 7.19 provides a listing of the parameters - indicating what the parameter denotes in the Feature geometry. All of the parameters are in millimeters or degrees and are in Double data type. For example, for a Sphere Feature, there must be four additional values on each data line beyond the Geometry Type and Bump Sign. These parameters are x-center, y-center, radius, and height/depth.

TABLE 7.19. Textured RepTile file parameter values for each geometry type.

Geometry Type	Parameter Number (Param@)													
	1	2	3	4	5	6	7	8	9	10	11	12	13	14
Cone	x center	y center	height/depth	end radius	cone angle	chamfer height	chamfer angle							
Sphere	x center	y center	radius	height / depth										
Hip Roof	x center	y center	height/depth	y width	y angle	x width	x angle	orient. angle						
Ellipsoid	x center	y center	center ht/dpth	x radius	y radius	z radius	x rotate	y rotate	z rotate					
Log	x center	y center	center ht/dpth	length	end1 radius	end2 radius	x rotate	y rotate	z rotate	radius ratio	axis rotate			
Enhanced prism	x center	y center	x width	y width	height/depth	x0 angle	x1 angle	y0 angle	y1 angle	orient. angle	y0 peak radius	y1 peak radius	y0 trough radius	y1 trough radius
Flattened Cone	x center	y center	height/depth	end radius	cone angle	peak radius	trough radius							
Pointed Cone	x center	y center	height/depth	cone angle	peak radius	trough radius								
DMD Mirror	x center	y center	height/depth	DMD thickness	DMD width	center hole width	post width	tilt (deg)	orientation (deg)					
Block	x center	y center	height/depth	x width	y width	z width	x rotate	y rotate	z rotate					
Chiseled Log	x center	y center	height/depth	cone length	end1 radius	end2 radius	end1 tilt	end2 tilt	radius ratio	orientation (deg)				
Torus	x center	y center	height/depth	major radius	minor radius									
Asphere	x center	y center	radius	curvature	conic constant	A ₁	A ₂	A ₃	A ₄	A ₅	A ₆	A ₇	A ₈	
Polygon	x center	y center	radius	depth/height	thickness	no. of sides	x rotate	y rotate	z rotate					
Pyramid	x center	y center	pyramid angle (deg)	no. of sides	orientation (deg)									
Circular Hip Roof	x center	y center	height/depth	inner radius	width	angle 0	angle 1							

CHAPTER 8

*Using the Macro Language***The Scheme Language** Standard Expert

TracePro includes the Scheme programming language, a powerful and flexible macro language for manipulating views, editing geometry, and writing macro programs, including looping and branching. There are thousands of macro commands available. To access the online documentation of macro commands, select **Help | Macro Reference** from the TracePro menu bar. The Macro Reference is designed to work like a help file; see Figure 8.1.

SCHEME, a dialect of the LISP language, was developed at MIT. LISP is used most often for artificial intelligence applications.

An advantage of the Scheme language for software developers is easy extensibility. TracePro is designed so that almost anything you can do in TracePro's user interface, you can also do in a Scheme command. A good way to get started with Scheme is to use the Macro Recorder feature in TracePro - **Macros | Recorder** - to see the Scheme commands corresponding to user input.

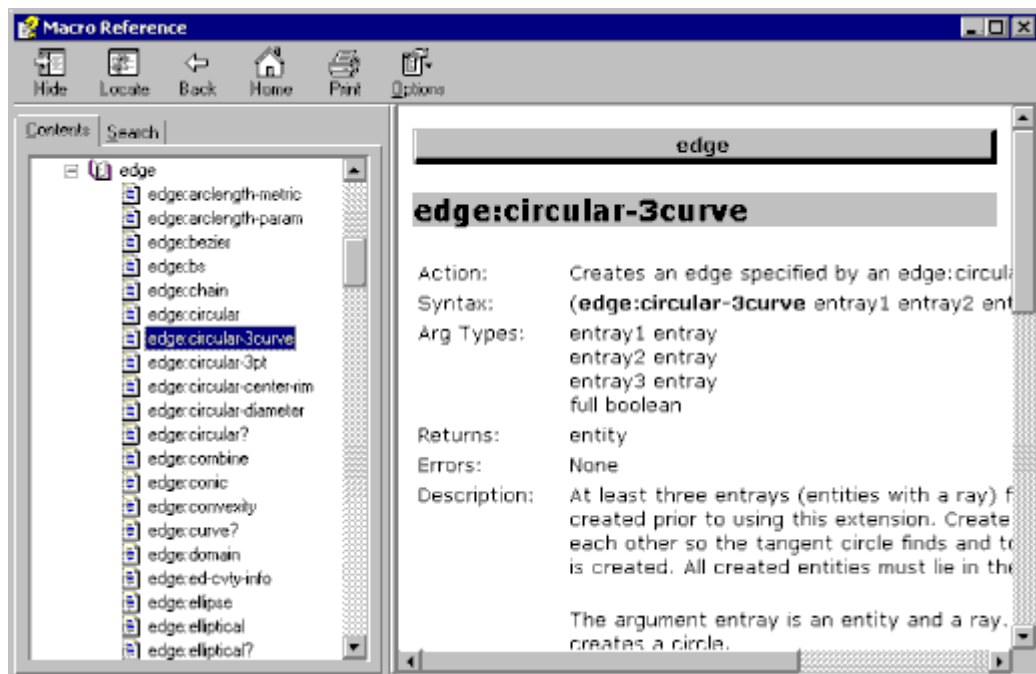

FIGURE 8.1 - The TracePro Macro Reference, Contents

Notepad++ Standard Expert

Overview

The Notepad++ text editor is available for creating and editing scheme macro files. Notepad++ is a full-featured, open-source, programmer's editor that has a language template for Scheme files. Notepad++ has been enhanced by Lambda Research with TracePro scheme extensions. You can start Notepad++ from the Macros menu in TracePro, or from Windows in the usual way.

Notepad++ has its own Help system.

Enabling auto-complete in Notepad++

TracePro installs Notepad++ during its installation process. However, auto-complete of commands is not enabled by default upon installing Notepad++. To enable auto-complete in Notepad++, select **Settings | Preferences** and select **Auto-compl etion**. Finally, check the *Enable auto-completion on each input* checkbox. You can also change the number of characters typed before auto-completion suggestions are displayed by changing the *From ___th character* setting.

Sending Scheme commands to TracePro

You can send a selection of code in a scheme file to TracePro for immediate execution. To do this, first select the lines you wish to send, then select **Plugins | TracePro | Send**, or Ctrl-F5. If nothing is selected, the entire file will be sent to TracePro.

Macro Recorder Standard Expert

The Macro Recorder captures the TracePro commands used during a session and stores the equivalent Scheme commands to a file. The stored file can be run by TracePro using the **Macros | Load** command to recreate the system and/or results stored between the **Macros | Recorder | Start** and **Macros | Recorder | Stop** commands. The file can also be edited and modified to return new results or become a function containing input parameters.

Recording States

During a Macro Recording the **Start** menu is altered to allow interruption in the recording process. The following options are displayed:

Start	No macro file is open. Press Start to create a new macro.
Pause	A macro file is open and commands are being stored to file. Press Pause to keep the current Macro file but temporarily halt recording.
Resume	A macro file is open but currently not receiving commands. Press Resume to resume recording.
Stop	A macro file is open and may be receiving commands as stated above. Press Stop to halt recording of the current macro and close the file.

Macro Format and Example

Selecting the **Macros | Recorder | Start** menu opens the Macro Recorder dialog. The **Macro Name** is the function to be defined and stored in the file given by **File Path**. Select **Record view change** to capture the Model and Window commands if you are changing between different Models or Views.



Figure 1 Macro Recorder

The following output was generated from a new Model Window. The GUI commands were used to create a sphere, apply the Schott BK7 material property, and trace the default ray grid.

```
(define Macro1
  (lambda ( )
    (define Macro1_ID_1
      (geometry:sphere 10))
    (property:apply-name Macro1_ID_1 "Sphere 1")
    (edit:move Macro1_ID_1 0 0 12)
    (property:apply-material (entity 19) "SCHOTT" "BK7" (gvector 0 0
0))
    (raytrace:set-grid-source-flag "Grid Source 1" #t)
    (raytrace:all-sources)
  ))
```

To recall this function, load the file using **Macros | Load** and select Macro1.scm, and enter the command in the Macro Window "(Macro1)". You can add arguments to use the recorded commands as a template or use the macro as recorded to return to a known model state.

Macro Command Examples

The following sections give a few examples of how Scheme commands can be used in TracePro. There are two ways to use Scheme commands:

1. As part of a Scheme program stored in a text file (with default extension ***.scm**), or

2. entered at the command line at the bottom of the message/macro window.

All the commands in the following sections can be entered at the command line to illustrate their effect.

Running a Macro Command from the Command Line

To issue a macro command, open the Macro Window that lets you run commands from the command line: select from the Macros menu, **Macros | Messages/ Macros**.

To enter a command, type into the one-line text box at the bottom of the Message/Macro window, Figure 8.2. To run a command, select the Execute button.

Note: All commands must be enclosed in parentheses.

The Message/Macro window can be re-sized by dragging a corner or edge with the mouse. It can be maximized or minimized using standard Windows buttons and menus.

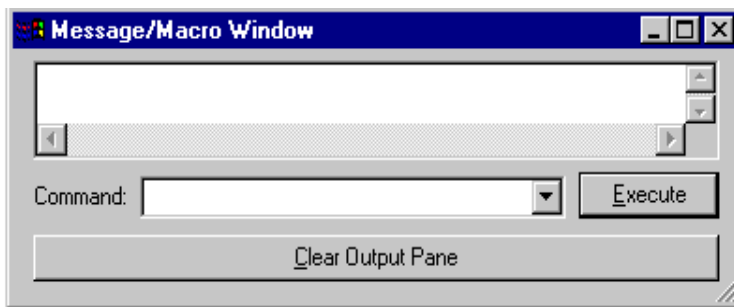

FIGURE 8.2 - The Message/Macro Output Window

Running a Scheme Program Stored in a File

To run a macro program, open its *.scm file in TracePro using **Macros | Load**. The file is loaded, then executed. Informative messages can be displayed in the Message/Macro window. This is the same window in which informative messages are displayed during ray tracing.

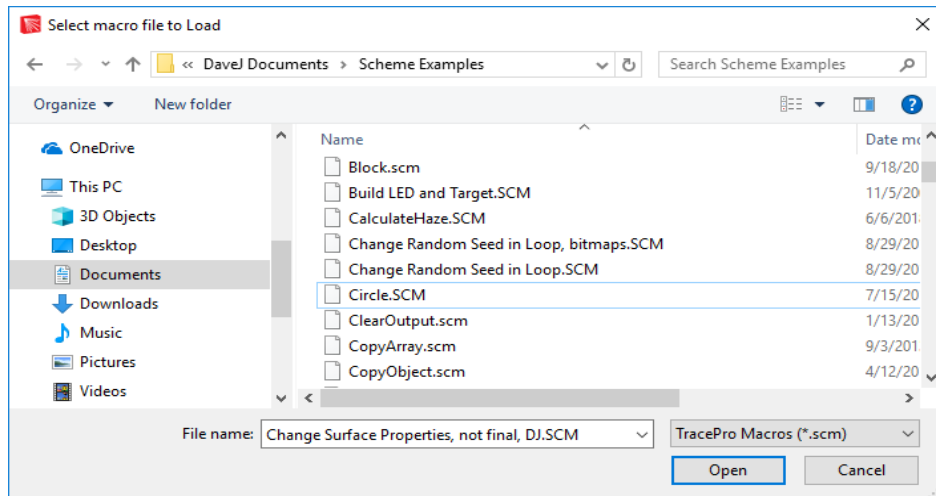

FIGURE 8.3 - The Macro|Load/Execute Dialog Box.

Creating Geometry

Solid objects are created using the `geometry` class, e.g., `(geometry:cylcone)` or `(geometry:block)`. Solids can also be named, so that they can be manipulated later, for example, moved, rotated, or used with a Boolean operation.

Create a solid block:

```
(geometry:block (position 0 0 0) (position 20 30 40))
```

This creates a block with one corner at (0,0,0) and the other at (20,30,40), oriented parallel to the coordinate axes.

Create a solid block named blk1:

```
(define blk1(geometry:block(position 0 0 0)(position 20 30 40)))
```

This creates a block with one corner at (0,0,0) and the other at (20,30,40), oriented parallel to the coordinate axes with the name `blk1`. Naming an object lets you perform additional operations on it. Names are active only during the macro command session. They are not saved with the model.

Create a solid cylinder:

```
(geometry:cylcone 30 10)
```

This creates a solid cylinder with one end at (0,0,0), length 30, and a radius of 10. The axis of the cylinder is along the z axis.

Create a solid elliptical cylinder:

```
(geometry:cylcone 30 10 5)
```

This creates a solid elliptical cylinder with one end at (0,0,0), length 30, and elliptical radii of 10 and 5. Note that the only difference between this command

and the previous one is the extra number in the argument list. The scheme interpreter determines from context that it should create an elliptical cylinder.

Create a solid cone:

```
(geometry:cylcone 30 10 10 5)
```

This creates a solid cone with one end at (0,0,0), the other end at (20,30,40), with a radius of 10 at the first end and 5 at the second end.

Create a solid elliptical cone:

```
(geometry:cylcone 30 10 5 5)
```

This creates a solid cone with one end at (0,0,0), with a major radius of 10 at the first end, minor radius of 5 at the first end, and major radius of 5 at the second end. The elliptical ends have the same ratio (2) between the major and minor axes.

Create a solid torus:

```
(geometry:torus 10 5)
```

This creates a solid torus with center at (0,0,0), a major radius of 10 and a minor radius of 5. The axis of symmetry of the torus is along the z axis. When the major radius is larger than the minor radius, a doughnut-shaped solid is created. When the major radius is smaller, an apple-shaped object is created. When the major radius is negative, a lemon-shaped solid is created.

Boolean Operations

You can perform Boolean operations from the command line as well.

Boolean subtract

```
(edit:boolean-subtract solid1 solid2)
```

This subtracts the solid named `solid2` from the solid named `solid1`. The resulting solid is named `solid1`. If more than two object names are given, all the subsequent objects are subtracted from the first one.

Boolean unite

```
(edit:boolean-unite solid1 solid2)
```

This unites the solid named `solid2` with the solid named `solid1`. The resulting solid is named `solid1`. If more than two object names are given, the union of all the objects is computed.

Boolean intersect

```
(edit:boolean-intersect solid1 solid2)
```

This intersects the solid named `solid2` with the solid named `solid1`. The resulting solid is named `solid1`. If more than two object names are given, the intersection of all the objects is computed.

Macro Programs

You can write your own macro programs and store them in ASCII text files. The default extension for scheme files is `scm`. You can create a file using any text editor. You run a stored macro program by opening the file using the **Macros | Load** menu selection within TracePro.

You can find some example macro programs on the Lambda Research web site (<http://www.lambdaires.com>) in the TracePro *Technical Support* section, under the hotlink name: *Examples*.

Accessing TracePro Menu Selections using Scheme

Many functions that can be performed using TracePro's user interface can also be performed by scheme commands. TracePro commands are grouped by the TracePro menu that they mirror.

The entire collection of macro commands are referenced in the online Macro Reference, which is available from the Start menu.

For more information on Scheme

See the Scheme home page at MIT:

<http://www-swiss.ai.mit.edu/scheme-home.html> (very technical)

and the reference book [The Scheme Programming Language](#), Fourth Edition, by R. Kent Dybvig (MIT Press). The book is available from booksellers, but the

author has also generously arranged for the entire text to be available online at <http://www.scheme.com/tspl4/>

TracePro COM Interface

TracePro includes a COM (Component Object Model) programming interface to allow TracePro to communicate with other Windows software. The COM support in TracePro allows you to write programs that control the execution of TracePro. This is done by passing strings containing Scheme commands to TracePro via the COM interface.

You can use any programming language that supports COM to create instances of TracePro COM objects and call the objects methods. The programming languages most commonly used are: Visual Basic, C# and C++.

This section assumes the reader is already familiar with COM programming.

TracePro COM

TracePro is an out-of-process COM server for use in COM clients running on the same computer as TracePro. Clients can create COM objects whether the server is running or not. The COM client will be able to start the registered release of TracePro. When TracePro is started via COM, the startup options, auto load scheme and check for updates will not be run. The COM programmer can use COM function calls to implement any desired startup behavior.

TracePro Type Library

The type library TracePro.tlb will contain the COM objects and interfaces for the different editions of TracePro. There is one type library installed with TracePro in the Program Files directory. You must import this type library into the C++ COM client programs that you create.

For Visual Basic and C# programs, Visual Studio reads the registry to find the installed typelibs and will list these as references. You will need to add a reference to the TracePro type library which will be listed as "TracePro Type Library" version 1.0.

TracePro<edition> Object

The TracePro<edition> COM objects are registered in the Windows registry and can be used to programmatically control TracePro. The edition can be either ST (TracePro Standard) or XP (TracePro Expert). Each TracePro edition executable will have a unique TracePro object that will provide methods to interact with TracePro. Use the version independent programmatic identifier for the edition of TracePro that is licensed, use TracePro.TraceProXP for TracePro Expert or TracePro.TraceProST for TracePro Standard. The edition COM objects implement the ITracePro interface to provide methods to interact with TracePro.

System calls to GetActiveObject will return the TracePro edition object for the first instance of TracePro that was running. If TracePro is not running it will return an error. Systems calls to CreateInstance will create a new object if one doesn't exist (thus starting TracePro) or will return the active TracePro edition object. The active TracePro edition object will be from the instance of TracePro edition that was started first. The TracePro edition object will also be registered with a

moniker that will allow the unique instance of the object to be found. The name will be TracePro_PID_ and where PID is the process id for the instance of TracePro. You can use this moniker name to connect to a specific instance of TracePro if you don't want the first instance.

TracePro Interface

HRESULT GetTraceProModulePathname([out, retval] BSTR* Pathname);

This method will return the full pathname to TracePro.

HRESULT GetVersionString([out, retval] BSTR *pVersion);

HRESULT Returns the string "Major.Minor.Release.Build".

HRESULT ExecuteSchemeString([in] BSTR Expressions, [out] BSTR* pResult, [out, retval] LONG* pNestLevel);

TracePro will execute the scheme code in Expressions and wait for it to complete. This behaves like the command line in the TracePro Message/Macro window.

Expressions: A string that contains the scheme code to execute. This string can represent several expressions and end with an incomplete scheme expression.

pResult: This will contain the string returned by the last complete command in Expressions or an error string if there was an argument error in a TracePro scheme command in Expressions. The processing of the Expressions will stop on an error or exception.

pNestLevel: This will contain the number of right parentheses that are required to complete an incomplete expression. It will be 0 if the last expression was complete or -1 if there was an error.

NOTE: We detect COM argument errors from TracePro scheme commands but ACIS prints the error messages and doesn't provide a way for us to know that there was a problem in ACIS scheme command or general scheme errors like the unbound variable.

HRESULT BackgroundExecuteSchemeString([in] BSTR Expressions);

TracePro will execute the scheme code in Expressions and return immediately before the scheme processing is complete.

Expressions: A string that contains the scheme code to execute. This string can represent several expressions and end with an incomplete scheme expression.

HRESULT LoadSchemeFile([in] BSTR SchemeFile, [out, retval] VARIANT_BOOL* pSuccess);

TracePro will load and execute SchemeFile.

SchemeFile: Pathname to a file that contains scheme code.

pSuccess: This will be true if the scheme code loads and executes without error. This will return false if there is an error and there should be an error message in the TracePro output window.

HRESULT IsUserInControl([out, retval] VARIANT_BOOL *pUserInControl);

This method returns true if the TracePro user interface is displayed.

HRESULT AllowUserControl();

The default MFC application that is also a COM server will not display the user interface when a COM object is created when the application is not running. Use this command to make the TracePro user interface visible if it wasn't already. NOTE: All COM objects will be destroyed if the user chooses to exit TracePro while the user interface is displayed and the user is in control.

Changing the TracePro COM server

If you would like to run a different installed release you will need to use TracePro.exe in the installation directory to register the COM objects. As administrator run:

```
TracePro.exe /register
```

If you install an Early Visibility (EV) release of TracePro and want your COM clients to communicate with the official release you will need to re-register the official release.

TracePro DDE Interface

TracePro may be controlled by another application using it as a DDE server. All DDE Service, Topic and Item names are insensitive to case. The DDE Execute command strings are also case insensitive. Since much of the interaction is based on sending Scheme commands, the interface is documented along with the Macro functionality.

Introduction

DDE (Dynamic Data Exchange) is a Windows protocol to share information between different programs. DDE uses a hierarchy of three names, the SERVICE, the TOPIC and the ITEM. A DDE CONVERSATION is established using the service and topic names as a pair. The item part of the name is used to identify the particular data or command being requested by the client once a conversation is established.

To establish a conversation a DDE client specifies the service/topic name pair it wishes to connect to. Windows broadcasts the request to all top level windows. The first server to accept is connected to the client and so a conversation is established. The application that initiates the conversation is called the client. The application that responds to the client application is called the server.

During a DDE conversation, the client and server applications exchange data concerning items. An item is a reference to data that is meaningful to both applications in a conversation. Either application can change the item during a conversation.

Just as the client application initiates the establishment of a conversation, it also initiates all the transactions. It can request data from the server as a once off (a REQUEST transaction), request being kept up to date about an item of data (an ADVISE or NOTIFY transaction), give commands to the server (an EXECUTE transaction) and send unsolicited data to the server (a POKE transaction). The client associates with all these transactions the item part of the identification. It informs the server of the data required by the client in a request transaction, the action to be taken by the server in an execute transaction or the data being passed to the server in a poke transaction.

It is also possible to use the item part of the name as the data itself, with the topic name indicating the context in which the data is to be used.

The Service Name

Every application that can be a DDE server has a unique service name. The service name is usually the application's executable filename without any extension. Service names are not case sensitive. Here are some commonly used service names:

- The service name for TracePro is TracePro.
- The service name for OSLO is OSLODDE.
- The service name for MATLAB is Matlab.
- The service name for Microsoft Word for Windows is WinWord.
- The service name for Microsoft Excel is Excel.

The Topic

The topic defines the subject of a DDE conversation and is usually meaningful to both the client and server applications. Topic names are not case sensitive. TracePro topics are System and Scheme and are described below.

The Item

Each topic supports one or more items. An item identifies the data being passed during the DDE conversation. TracePro items are not case sensitivity. The scheme items are simply TracePro macro commands passed to the Server for execution. The command results may be retrieved by the client using a REQUEST transaction or simply sent to TracePro via a EXECUTE transaction.

Clipboard Formats

DDE uses the Windows clipboard formats for formatting data sent between applications. TracePro supports only Text format for its Server mode.

TracePro DDE Server

If you request "Systems" on the System topic, you get a list of items available on that topic:

- Systems - returns a tab separated list of items.
- Topics - returns "System" and "scheme" topics.
- Formats - returns the available formats for data transfer. The Text format is the only supported format for TracePro.
- TopicItemList - returns a tab separated list of items for the current Topic.

The format Text (CF_TEXT) must be used for all requests on the System topic.

Establishing a Conversation

When you access TracePro as a server, you must specify its service name and one or more topics to establish a CHANNEL. TracePro can support multiple channels from one or more applications. Generally the System topic is used to

obtain information on the topics and items supported for a particular server. The Scheme topic does not provide any specific Items but will attempt to execute the text sent to the server as an TracePro macro command. If the Request transaction is used, the result of the TracePro command will be returned as a text string.

Excel 97/2000 Example

The following example illustrates a DDE conversation between MS Excel and TracePro. The DDEInitiate command is used to open Channels for the Scheme topic. A DDEExecute is used to open a new model by sending a command to TracePro with no return value. The Conversation is ended with the DDETerminate commands.

```
Public Sub DDEtoTracePro()  
  
    Dim strApp As String  
    Dim strTopic As String  
  
    strApp = "TracePro"  
    strTopic = "scheme"  
  
    channelNumber = Application.DDEInitiate(strApp, strTopic)  
  
    Application.DDEExecute channelNumber, "(file:new)"  
  
    Application.DDETerminate channelNumber  
End Sub
```

RepTile Examples Expert

In general, the steps involved in using RepTile surfaces consist of first creating a RepTile surface property within TracePro and then applying that property to a plane surface in your TracePro model. All the examples in this section are similar in construction. You should choose an example that is most like the model you wish to create and follow through the steps for creating the example.

Fresnel lens

In this example we will create a Fresnel lens. Some of the important features of a Fresnel lens are shown in Figure 9.1

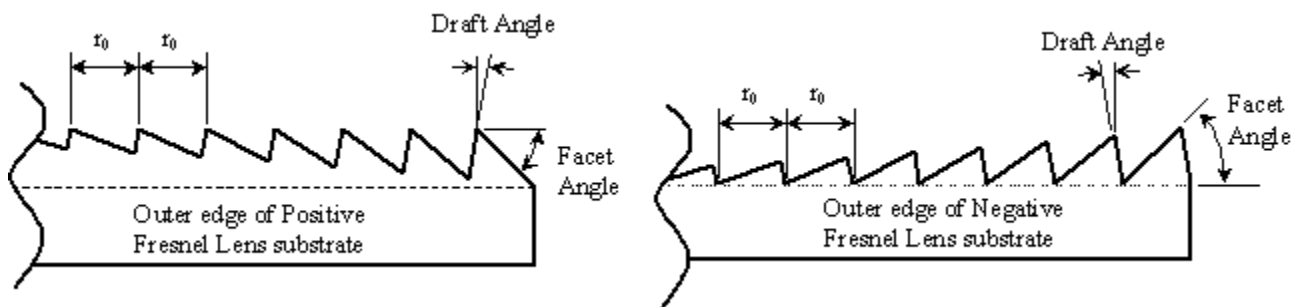

FIGURE 9.1 - Important construction features of positive and negative Fresnel lenses.

In order to begin analyzing a Fresnel lens, you will need to acquire data about the desired facet angles. If you are analyzing a lens that has already been fabricated, this data will be available from the manufacturer. If you are analyzing a Fresnel lens that is in its design stage, you will have to get the facet angle data from calculations (possibly from a specialized optical design program) outside of TracePro.

For purposes of this exercise, we have supplied an example file containing facet angle data. The data for the angular facets of the Fresnel lens example is contained in the *Fresnel Lens Arcsecs.txt* file, which can be found in the Technical Support section of the Lambda Research web site. This text file contains one whole number per line – the number is the Fresnel lens facet angle in arcseconds. In order to use this file, we will need to convert the angles to degrees. To examine this file, open it using a spreadsheet program such as Microsoft Excel. The facet angles increase from the center to the edge of the lens. In order to calculate the minimum thickness we need for the substrate, we need to know the largest facet angle. This is the last angle in the file. You can quickly go to the last row in the spreadsheet in Excel by pressing <Ctrl - ↓> on your keyboard. The Excel screen should look like Figure 9.2, showing that there are 333 rows in the spreadsheet and the last facet angle is 171682 arcsec or 47.68944 degrees. Assuming that each facet has a width of 0.5 mm, the depth of the last facet is $0.5 \text{ mm} \times \tan(47.68944^\circ) = 0.549 \text{ mm}$. We can make the substrate 2 mm thick, and the last

Examples

facet will still have a base thickness of almost 1.5 mm (substrate thickness – tallest facet height = base thickness).

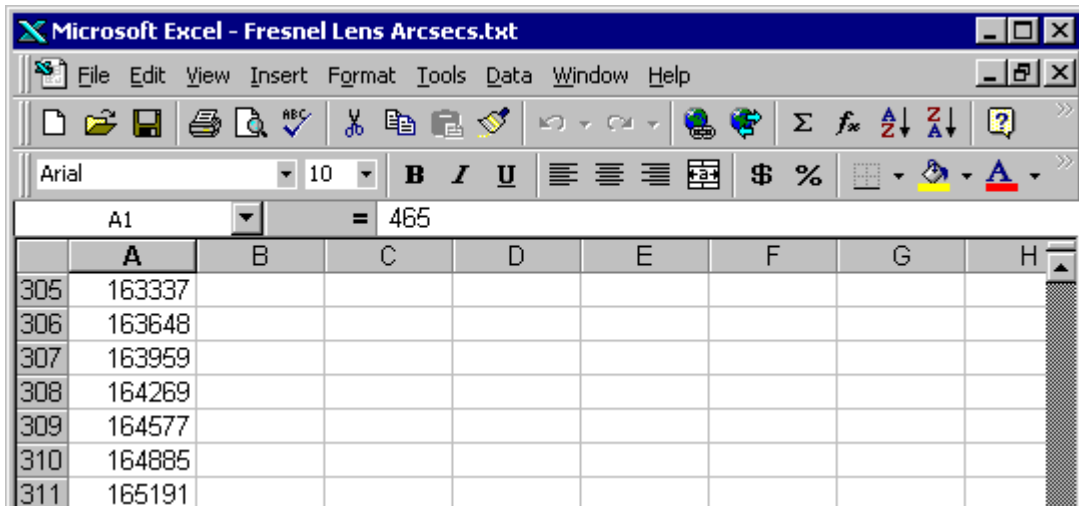

	A	B	C	D	E	F	G	H
305	163337							
306	163648							
307	163959							
308	164269							
309	164577							
310	164885							
311	165191							

FIGURE 9.2 - The Fresnel Lens Arcsecs.txt file as it appears in Microsoft Excel.

First we will create a RepTile Surface property that describes the Fresnel lens. Open the Reptile Property Editor by selecting **Define | Edit Property Data | RepTile Properties**. The editor appears as in Figure 9.3.

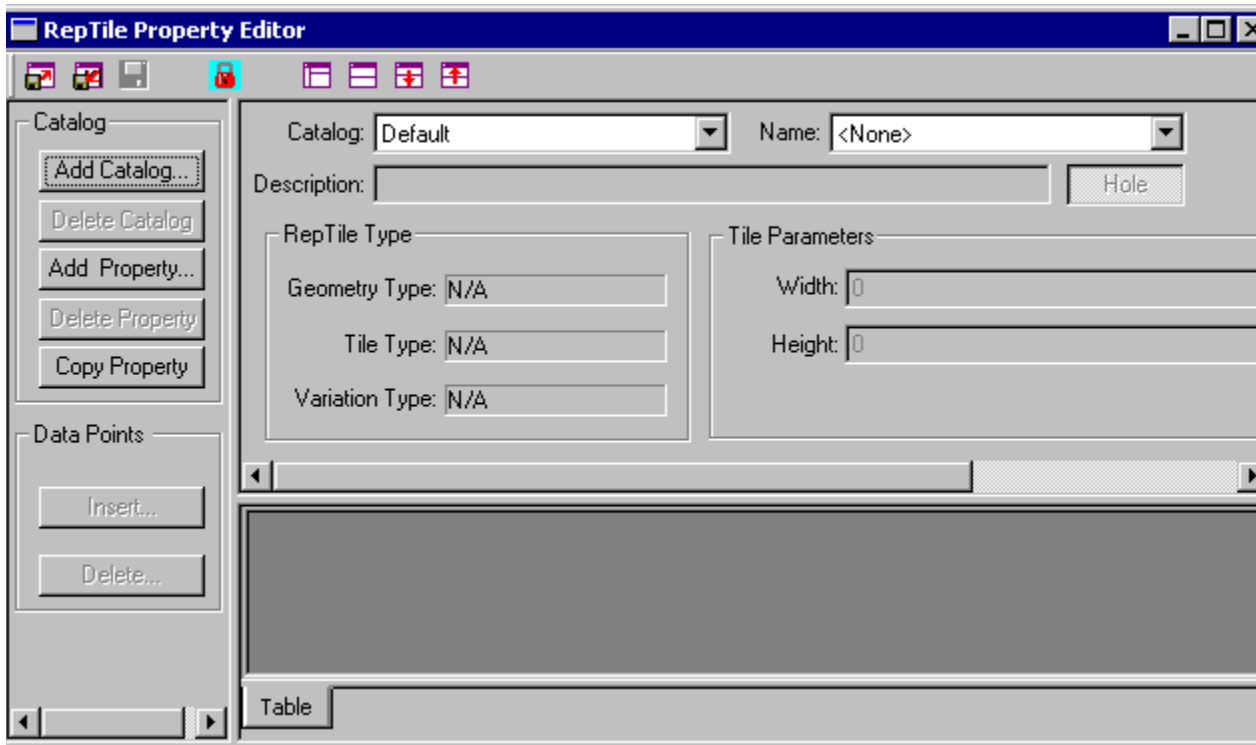

FIGURE 9.3 - The RepTile Property editor with no property selected.

To add the new property:

1. Press *Add Property*, and enter a name, for example *Fresnel Lens Example*,
2. select *Fresnel* from the *Geometry Type* drop-down list in the pop-up dialog,
3. select *Rings* from the *Tile Type* drop-down list in the dialog,
4. select *Variable Rings* from the *Variation Type* drop-down list in the dialog,
5. press OK to create the property.

The RepTile Property Editor will display the property and provide additional inputs as shown in Figure 9.4.

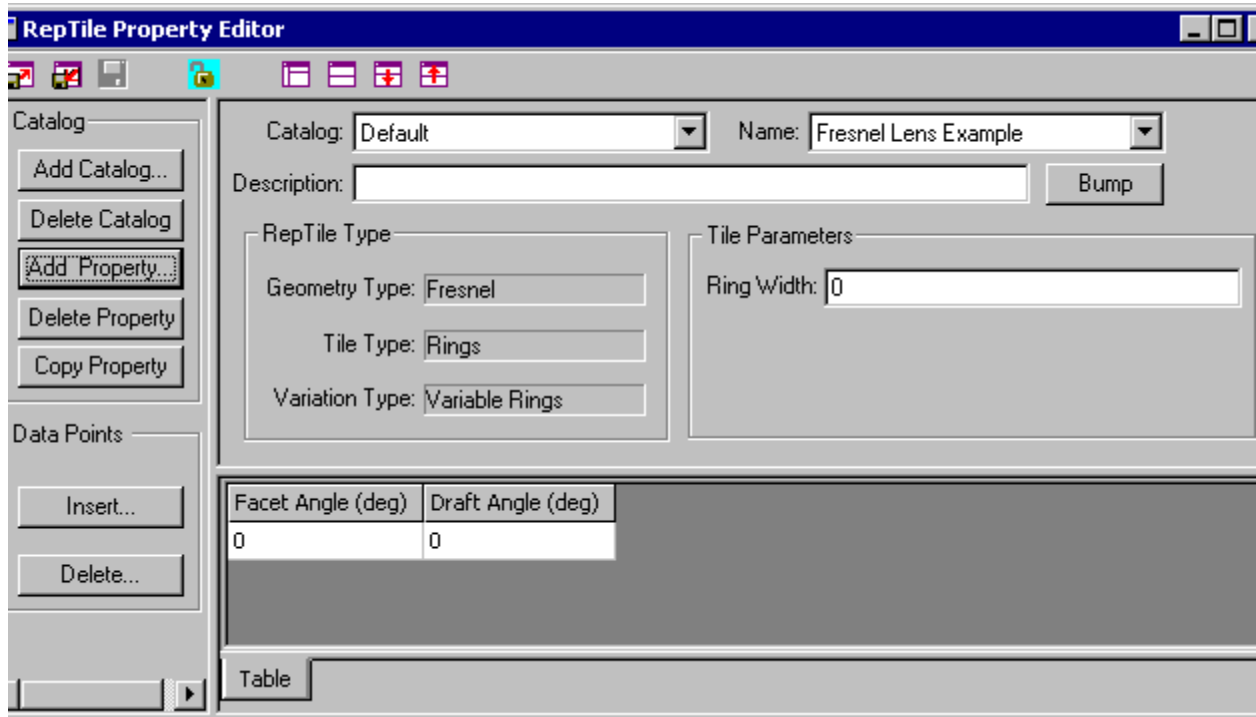

FIGURE 9.4 - A template for the Fresnel Lens Example RepTile property.

6. Continue to enter the property data by entering 0.5 in the *Ring Width* box (the ring width in mm).

We now have a template for creating the Fresnel Lens RepTile property. To fill in the facet angle and draft angle data, we will export this property to a text file and use a spreadsheet program.



To export the property, first select **File | Save** to save the property, then select **File | Export Property** to save the property in a text file. Open the text file using a spreadsheet program (Microsoft Excel was used in this example). The opened file should appear as in Figure 9.5

	A	B	C	D	E	F	G	H
1	TracePro RepTile Property Data							
2	File Name	C:\Program Files\Lambda Research Corporation\TracePro\TracePro.mdb						
3	TracePro Release:	3 3 0						
4	Database Version:	3 3 0						
5	Data generated at	08:50:50 March 11, 2005						
6								
7	Name	Fesnel Lens Example						
8	Catalog	Default						
9	Description							
10	Geometry_	1						
11	Tile_Type	1						
12	Vary_Row:	1						
13	Bump_Typ	0						
14	Parameter	0						
15	Width_X	0.5						
16	Width_Y	0						
17	User_Data	1						
18								
19	Facet Ang	Draft Angle (deg)						
20	0	0						
21								
22								

FIGURE 9.5 - The *Fresnel Lens Example* RepTile property exported text file after opening in Excel.

With the *Fresnel Lens Arcsecs.txt* file open in Excel, make a second column that is calculated from the first column. The second column should be the facet angle in degrees, obtained by dividing the first column by 3600. The first few rows of the *Fresnel Lens Arcsecs.txt* file should appear as in Figure 9.6.

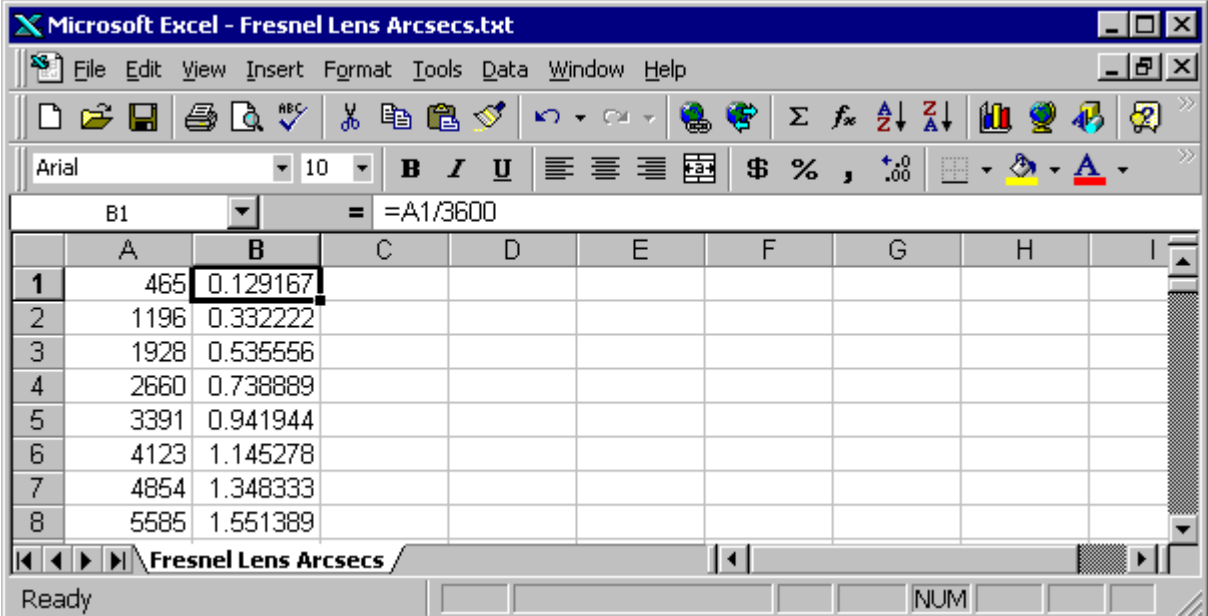

The screenshot shows the Microsoft Excel interface with the file *Fresnel Lens Arcsecs.txt* open. The spreadsheet displays two columns of data. Column A contains the original values, and Column B contains the calculated facet angles in degrees, which are the values from Column A divided by 3600. The formula bar at the top shows the formula for cell B1: $=A1/3600$.

	A	B	C	D	E	F	G	H	I
1	465	0.129167							
2	1196	0.332222							
3	1928	0.535556							
4	2660	0.738889							
5	3391	0.941944							
6	4123	1.145278							
7	4854	1.348333							
8	5585	1.551389							

FIGURE 9.6 - The *Fresnel Lens Arcsecs* file with a second column containing facet angles in degrees.

Examples

Select the entire column B, copy it, and paste it to cell A19 of the *Fresnel Lens Example* property file using *Paste Special* and specifying *Values*. (You can select the column quickly by selecting cell B1 in *Fresnel Lens Arcsecs* and pressing <Shift - Ctrl - ↓> to select the column). Enter an angle of 2 in the second column for the *Draft Angle*. Each facet can have a different angle but we will use a constant 2 degrees for this example. The property should appear in Excel as shown in Figure 9.7

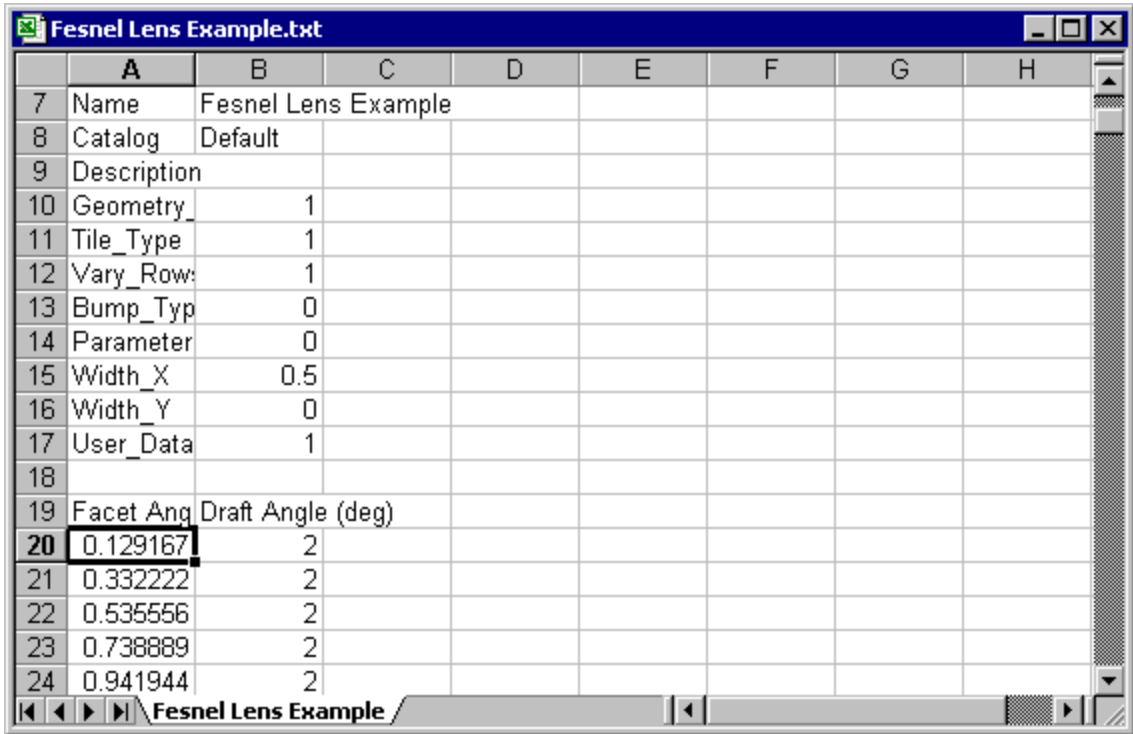

	A	B	C	D	E	F	G	H
7	Name	Fesnel Lens Example						
8	Catalog	Default						
9	Description							
10	Geometry	1						
11	Tile_Type	1						
12	Vary_Row	1						
13	Bump_Type	0						
14	Parameter	0						
15	Width_X	0.5						
16	Width_Y	0						
17	User_Data	1						
18								
19	Facet Ang	Draft Angle (deg)						
20	0.129167	2						
21	0.332222	2						
22	0.535556	2						
23	0.738889	2						
24	0.941944	2						

FIGURE 9.7 - The completed Fresnel Lens Example as shown in Excel.



Now save the *Fresnel Lens Example.txt* file from Excel and close it. Switch back to TracePro and select **File | Import Property** with the RepTile Property Editor open. Open the *Fresnel Lens Example.txt* file to import it. The editor window should appear as in Figure 9.8.

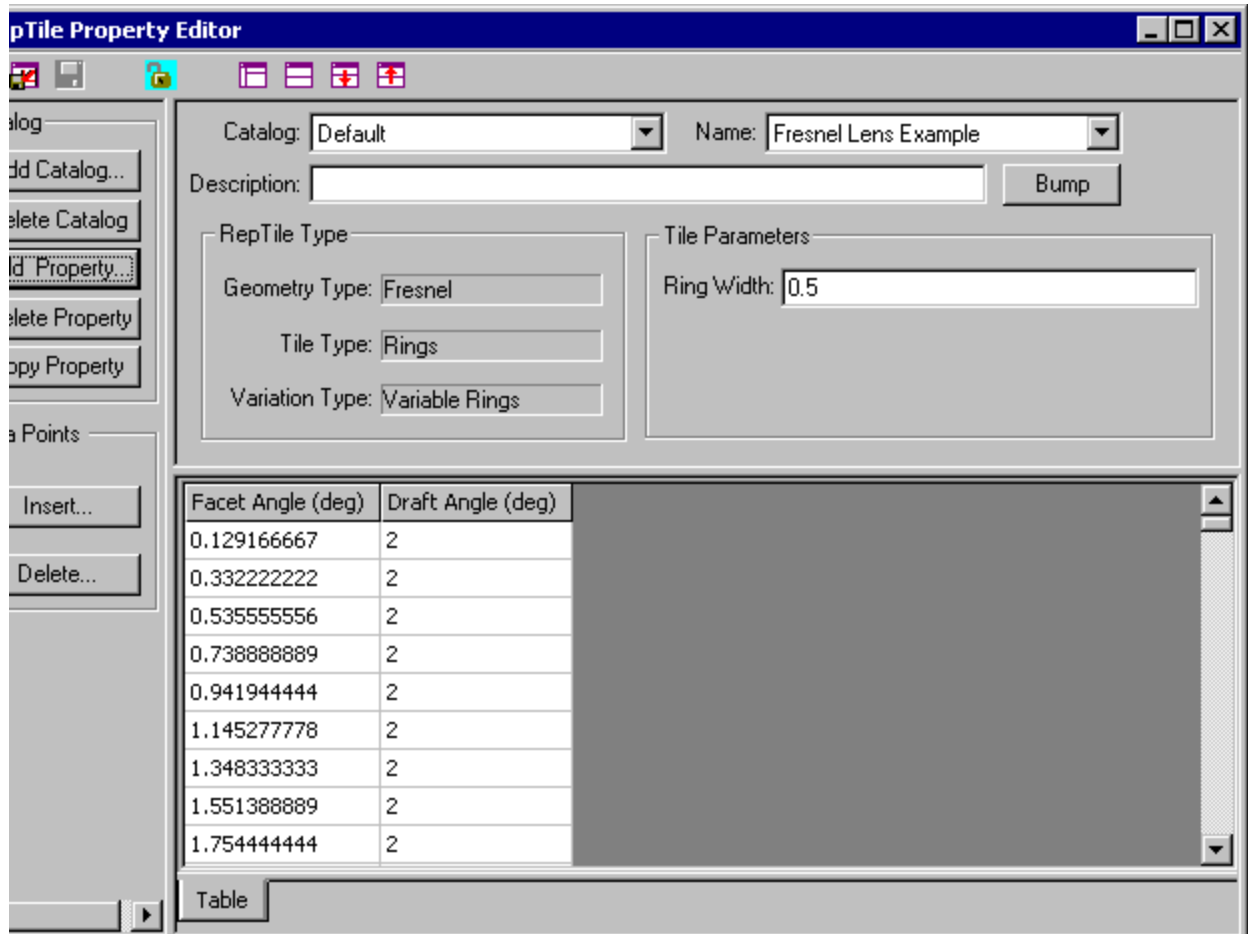

FIGURE 9.8 - The completed Fresnel Lens Example property after importing into the Property Editor.

This completes the definition of the Fresnel Lens Example in the Property Editor. Close the Property Editor, and choose to save your data when the appropriate pop-up window appears.

Now we are ready to make an object and apply the RepTile property we have just created. First we need to figure out the dimensions the object should have. We already know that it should be 2 mm thick. We also know that there are 333 facets of width 0.5 mm, so the radius of the outermost facet is $333 \times 0.5 \text{ mm} = 166.5 \text{ mm}$. If we use a square boundary for the Fresnel lens, the largest it can be is $166.5 \text{ mm} \times \sqrt{2} = 235 \text{ mm}$ on a side. We also must have a margin around the RepTile Surface cell boundary to allow rays to escape properly. Therefore we will make an object that is 240 mm x 240 mm, and 2 mm thick.

- In TracePro, using the **Geometry|Primitive Solid** dialog box, insert a block with dimensions as shown in Figure 9.9.

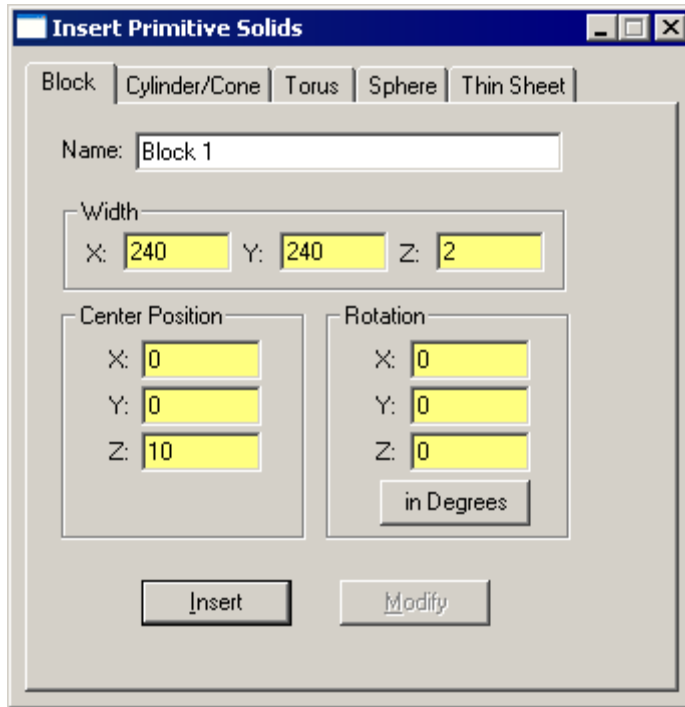

FIGURE 9.9 - Insert a block into a TracePro model as a substrate for the Fresnel lens.

- Using the *Apply Properties* dialog box, apply the material property *pmma* from the *Plastic* catalog to the block.
- Now select the $-z$ surface of the block and apply the RepTile surface property using the *RepTile* tab in the *Apply Properties* dialog box. Fill in the values shown in Figure 9.10.

This puts the center of the Fresnel lens at the center of the block surface.

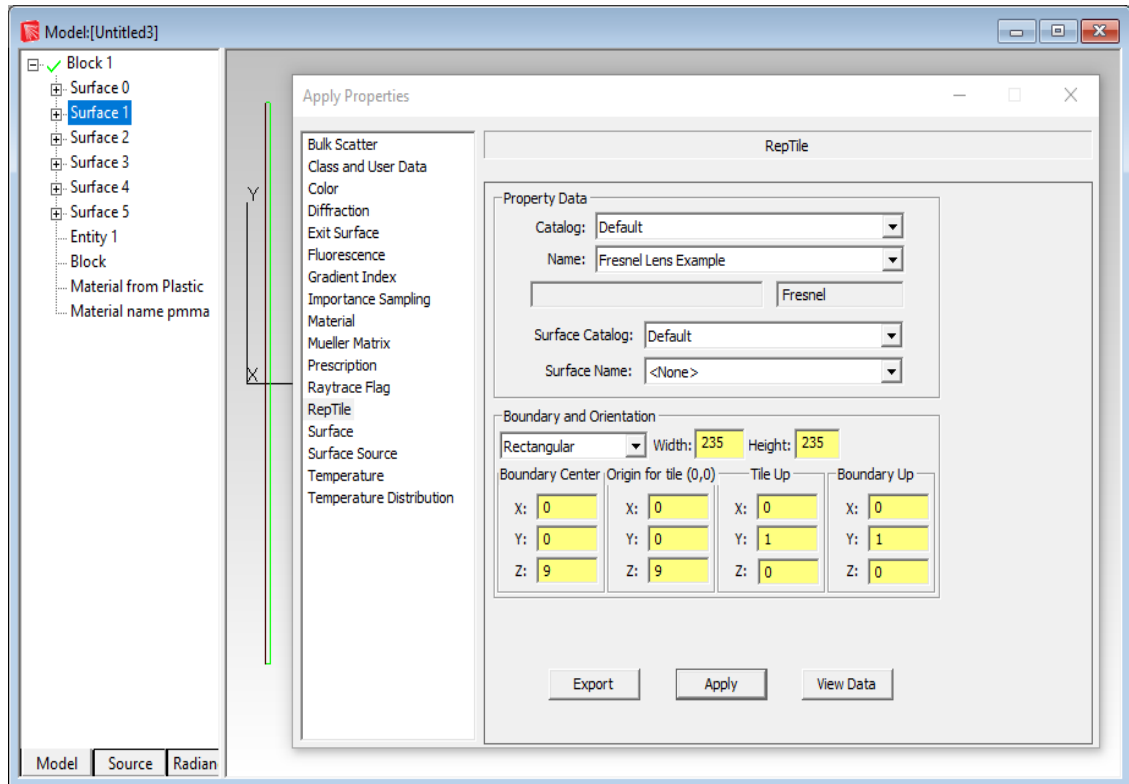

FIGURE 9.10 - Insert a block and apply the Fresnel Lens Example RepTile property to it.

The Fresnel lens is now complete. Note that there will be no visual indication in the model window that the RepTile surface properties have been applied unless the **View|Display RepTiles** option is enabled. The System Tree will show the *Fresnel Lens Example* property on the appropriate surface. The facets are defined over a 235 mm x 235 mm square area within a 240 mm x 240 mm surface.

Next, we'll trace some rays through the Fresnel lens.

10. Define a square grid of rays 119 x 119 mm half-widths with a rectangular grid of 100 x 100 rays as shown in Figure 9.11.

The completed ray-trace is shown in Figure 9.12. We see that the focal length of this lens is about 310 mm.

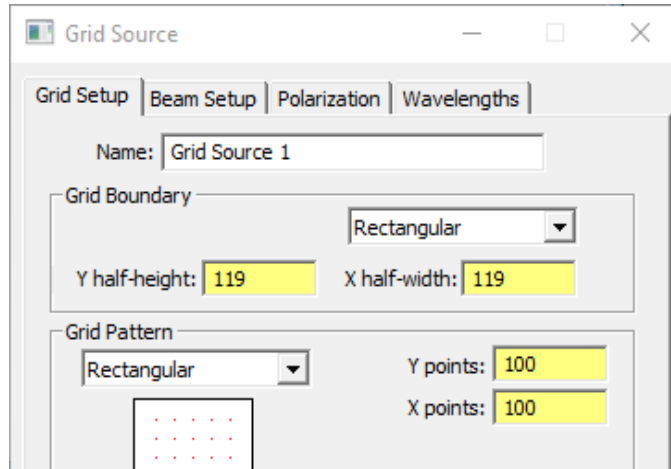

FIGURE 9.11 - Modified portion of Grid Source dialog for Rectangular raytrace.

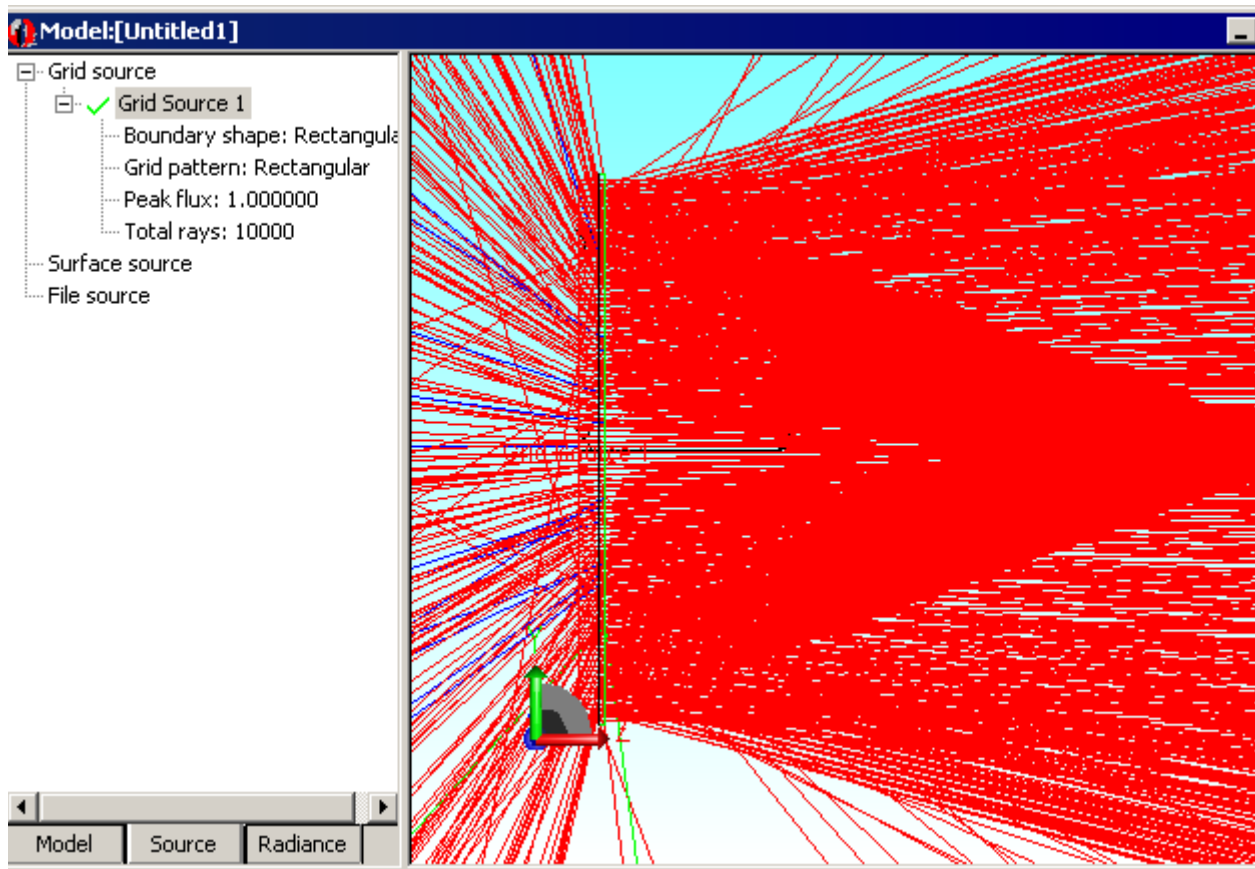

FIGURE 9.12 - Completed ray-trace of Fresnel lens example.

Conical hole geometry with variable geometry, rectangular tiles and rectangular boundary

In this example we will create a surface tiled with conical holes and rectangular tiles. We will create a conical hole property with the following dimensions:

- Cone end radius = variable by row, from 0.1 mm to 0.2 mm in steps of 0.001 mm.
- Cone height = 0.03 mm.
- Cone angle = 0.
- Chamfer height = 0.02 mm.
- Chamfer angle = 50°.
- Rectangular tiles, 0.25 mm x 0.25 mm.

These dimensions dictate that there will be 101 rows. Each row is 0.25 mm high, so the total “y height” of the tiles will be 101 x 0.25 mm = 25.25 mm.

Now we will create the RepTile surface property.

1. Open the RepTile Property Editor by selecting **Define|EditPropertyData|RepTile Properties**. The editor appears as in Figure 9.3 on page 9.2.
2. Press *Add Property* and enter a name, for example *Conical Hole Example*,
3. select *Cone* from the *Geometry Type* drop-down list,
4. select *Rectangles* from the *Tile Type* drop-down list,
5. select *Variable rows* from the *Variation Type* drop-down list,
6. and click OK. (See Table 9.13)

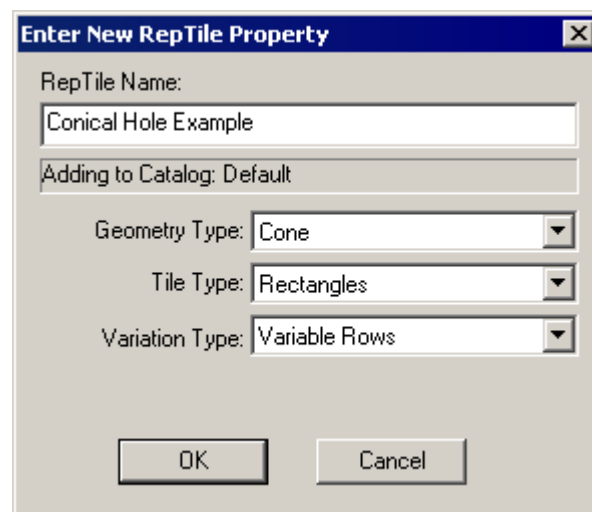

FIGURE 9.13 - Enter New RepTile Property dialog for Conical Hole Example.

7. In the Tile Parameters area, enter 0.25 for both the *Width* and *Height* values.
8. Click the *Bump* button and observe that it changes to *Hole*, specifying “hole” geometry.

- Enter the geometry values above into the appropriate columns in the table. The entries should appear as in Figure 9.14.

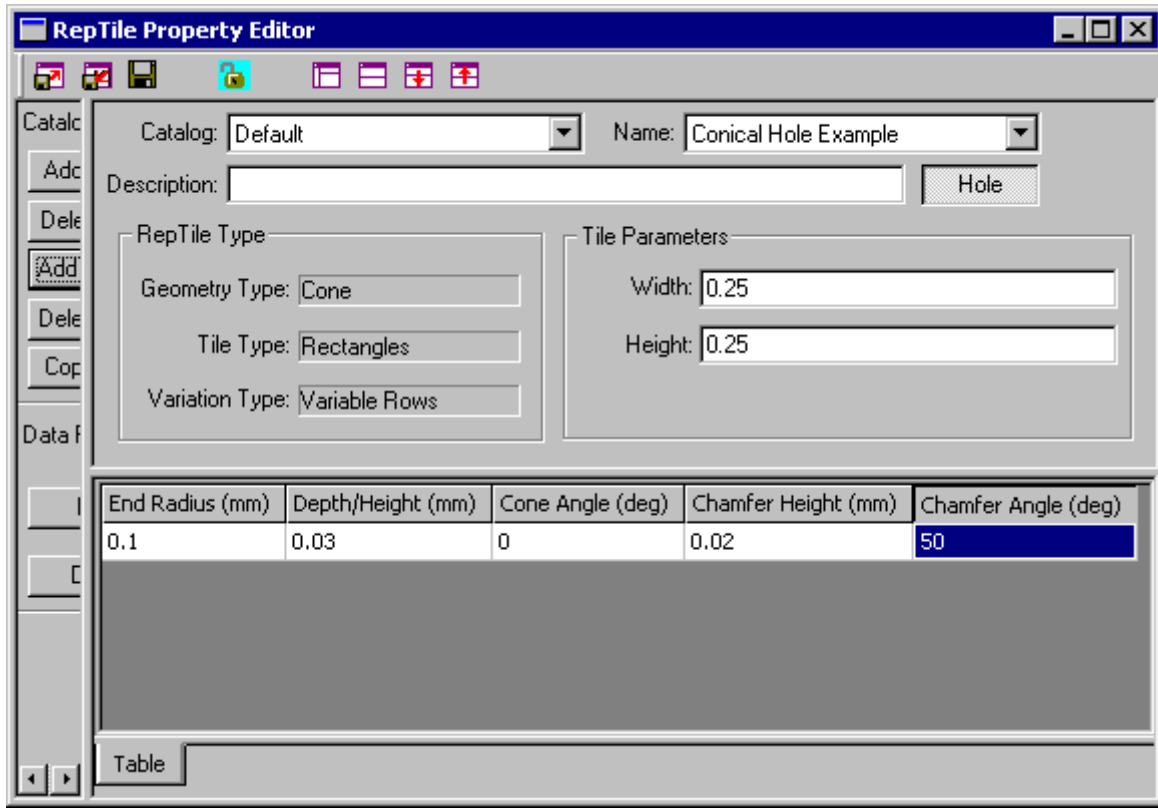

FIGURE 9.14 - Completed template for Conical Hole property example.

We now have a template for creating the Conical Hole property. To fill in the geometry data, we will export this property to a text file and use a spreadsheet program.



To export the property, first select **File | Save** to save the property, then select **File | Export Property** to save the property in a text file. Open the text file using a spreadsheet program (Microsoft Excel in this example). The opened file should appear as in Figure 9.15.



	A	B	C	D	E	F	G	H
1	TracePro RepTile Property Data							
2	File Name C:\Program Files\Lambda Research Corporation\TracePro\TracePro.mdb							
3	TracePro Release: 3 3 0							
4	Database Version: 3 3 0							
5	Data generated at 11:36:23 March 11, 2005							
6								
7	Name	Conical Hole Example						
8	Catalog	Default						
9	Description							
10	Geometry	2						
11	Tile_Type	2						
12	Vary_Row	1						
13	Bump_Typ	1						
14	Parameter	0						
15	Width_X	0.25						
16	Width_Y	0.25						
17	User_Data	1						
18								
19	End Radiu	Depth/Heig	Cone Angl	Chamfer H	Chamfer Angle (deg)			
20	0.1	0.03	0	0.02	50			
21								
22								
23								
24								
25								
26								
27								
28								
29								

FIGURE 9.15 - The *Conical Hole Example* RepTile property exported text file after opening in Excel.

10. Fill in the End Radius column, increasing the value by 0.001 with each additional row, until you get to 0.2. (You can do this quickly by putting the formula $=A20+.001$ in cell A21, then copying cell A21 down to fill in all the values.)

11. Copy the other columns down until you fill in the table.

Figure 9.16 shows the first few rows and the last few rows of the completed *Conical Hole Example.txt* file.

	A	B	C	D	E	F	G	H
1	TracePro RepTile Property Data							
2	File Name	C:\Program Files\Lambda Research Corporation\TracePro\TracePro.mdb						
3	TracePro Release:	3 3 0						
4	Database Version:	3 3 0						
5	Data generated at	11:36:23 March 11, 2005						
6								
7	Name	Conical Hole Example						
8	Catalog	Default						
9	Description							
10	Geometry_	2						
11	Tile_Type	2						
12	Vary_Row:	1						
13	Bump_Typ	1						
14	Parameter	0						
15	Width_X	0.25						
16	Width_Y	0.25						
17	User_Data	1						
18								
19	End Radiu	Depth/Heic	Cone Angl	Chamfer H	Chamfer Angle (deg)			
20	0.1	0.03	0	0.02	50			
21	0.101	0.03	0	0.02	50			
22	0.102	0.03	0	0.02	50			
23	0.103	0.03	0	0.02	50			
117	0.197	0.03	0	0.02	50			
118	0.198	0.03	0	0.02	50			
119	0.199	0.03	0	0.02	50			
120	0.2	0.03	0	0.02	50			
121								
122								

FIGURE 9.16 - The *Conical Hole Example.txt* file with all values filled in.

12. Now save the *Conical Hole Example.txt* file from Excel and close it.



13. Switch back to TracePro and select **File | Import Property** from the Property Editor.

14. Open the *Conical Hole Example.txt* file to import it.

The editor window should appear as in Figure 9.17.

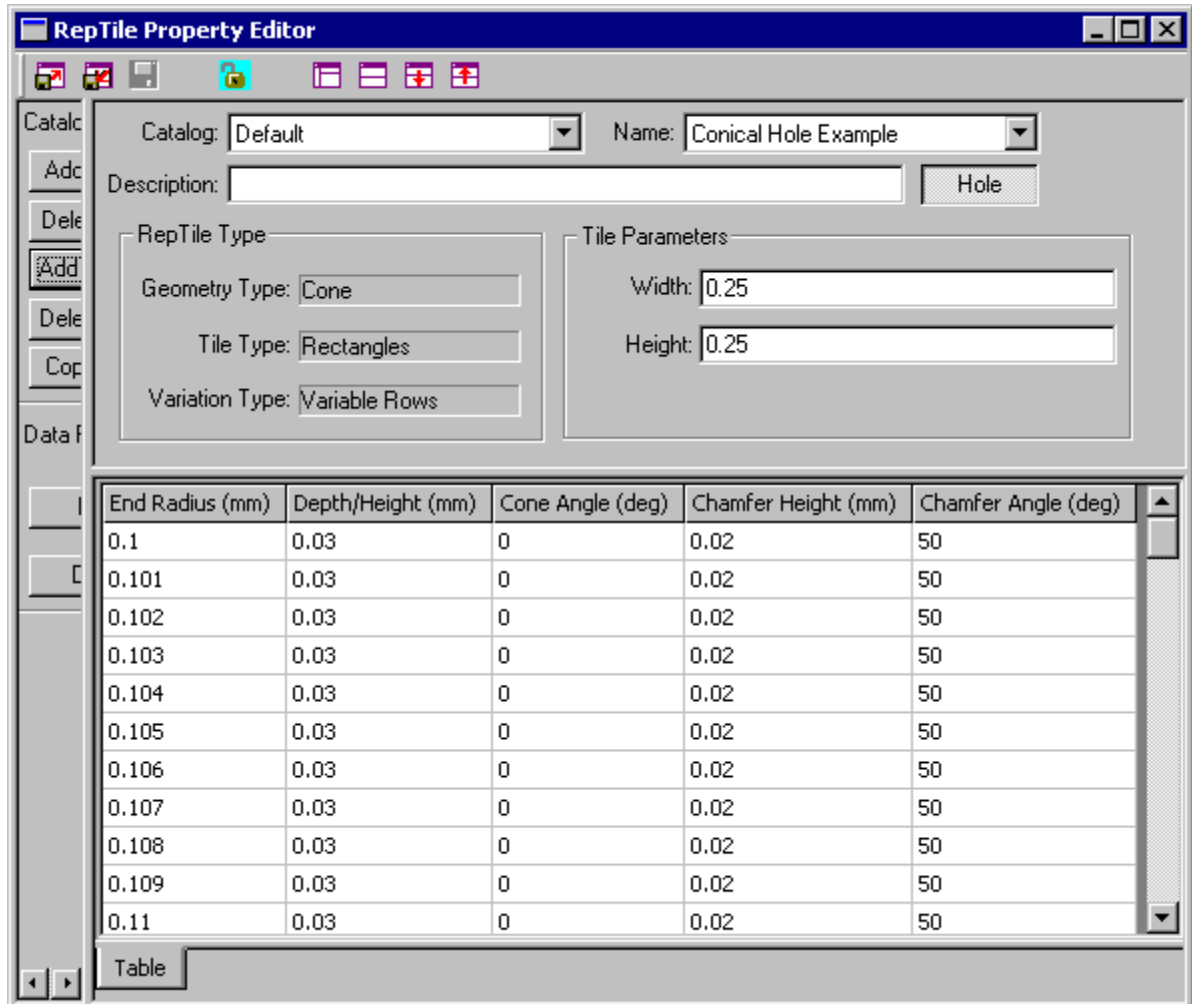

FIGURE 9.17 - The completed Conical Hole Example property after importing into the Property Editor.

This completes the definition of the Conical Hole Example in the Property Editor. Close the Property Editor, and choose to save your data when the appropriate pop-up window appears.

Now we are ready to make an object and apply the property we have just created. First we need to figure out the dimensions the object should have. An appropriate thickness is 2 mm. We also know that total height of the rows is 25.25 mm. We are free to choose the width - let's choose the width as 100 mm. We also must have a margin around the RepTile surface cell boundary to allow rays to escape properly. Therefore we will make an object that is 30 mm x 105 mm, and 2 mm thick, oriented so that the 30 mm dimension is along the z axis.

15. In TracePro, using the **Geometry | Primitive Solid** dialog box, insert a block with dimensions as shown in Figure 9.18.

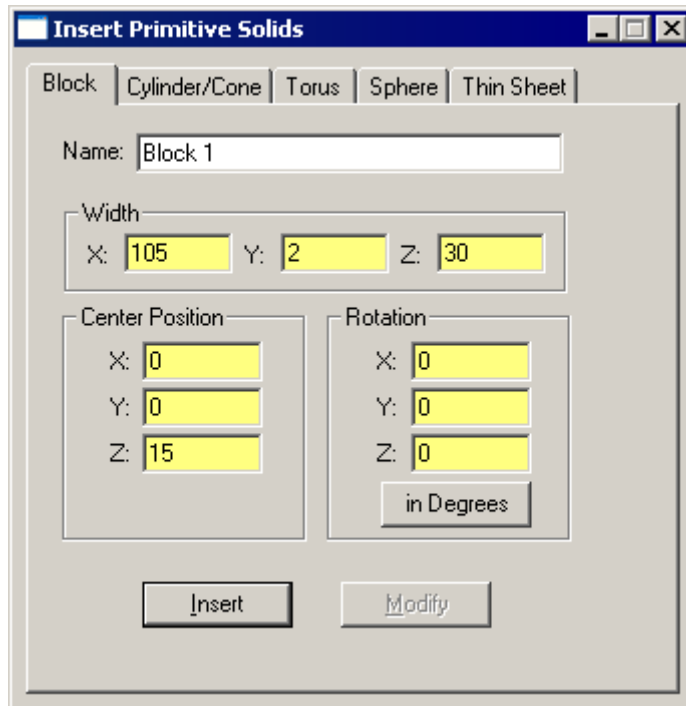

FIGURE 9.18 - Insert a block into a TracePro model as a substrate for the Conical Hole surface.

16. Using the *Apply Properties* dialog box, apply the material property *pmma* from the *Plastic* catalog to the block.
17. Now select the +y surface of the block and apply the RepTile property using the *Apply Properties* dialog box.
18. Fill in the values shown in Figure 9.19. This puts the (0,0) tile at the -z edge of the rectangular boundary.

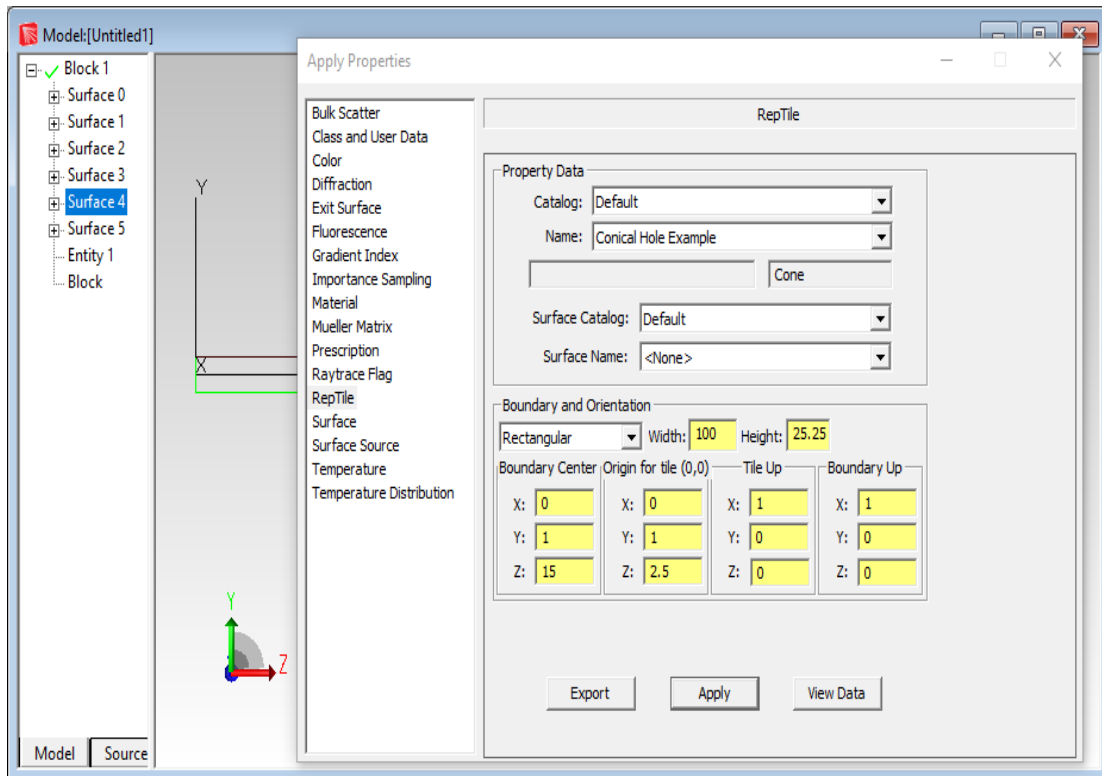

FIGURE 9.19 - Insert a block and apply the Conical Hole Example RepTile property to it.

The Conical Hole example is now complete. Note that there will be no visual indication in the model window that the RepTile surface properties have been applied, but the System Tree will show the Conical Hole Example property on the appropriate surface. The facets are defined over a 100 mm x 25.25 mm rectangular area within a 105 mm x 30 mm surface, with the first row of the surface at $z=0.125$. As you go along the $+z$ axis the row number increases and the geometry changes. Next, we'll trace some rays into the edge of the block. Define a rectangular grid of rays with 50 x 0.5 mm half-widths with a rectangular grid of 100 x 100 rays and half-angle (divergence) of 30 degrees. The completed ray-trace is shown in Figure 9.20.

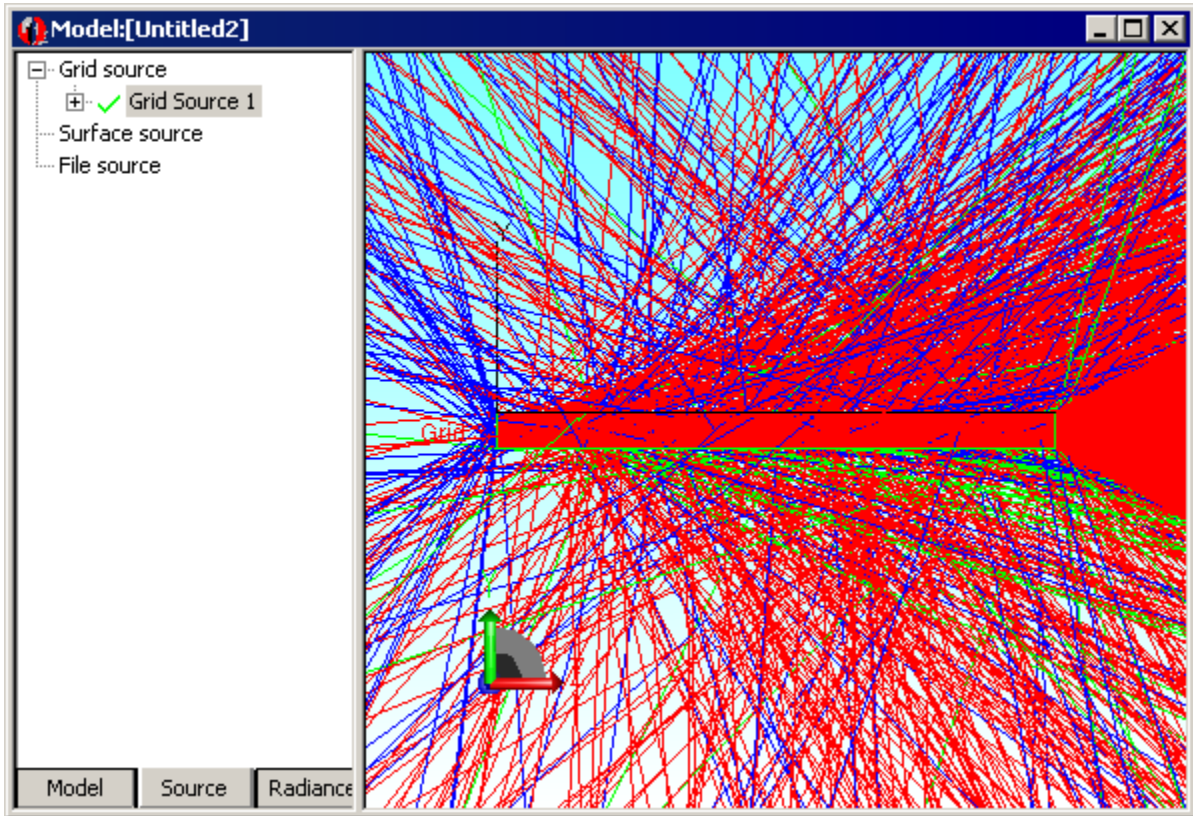

FIGURE 9.20 - Completed ray-trace of Conical Hole Example.

Parameterized spherical bump geometry with staggered ring tiles

In this example we will create a surface tiled with spherical bumps in staggered tiles. The property dimensions will be parameterized to vary as the bumps extend outward from the center of the RepTile circular boundary. We will create a spherical bump property with the following dimensions:

- Sphere radius = $0.05 + (\text{Iring}/5)$ mm.
- Sphere height = $\text{Iring}/2$ mm.
- Ring width = $0.1 + 0.7 * \text{Iring}$ mm.
- Each ring will have 5 segments starting at different angles = $10 * \text{Iring}$.

The resulting RepTile property placed on the end of a 12 mm cylinder is shown Figure 9.21. The parameter variable **Iring** starts from the center and increases by one for each ring outward.

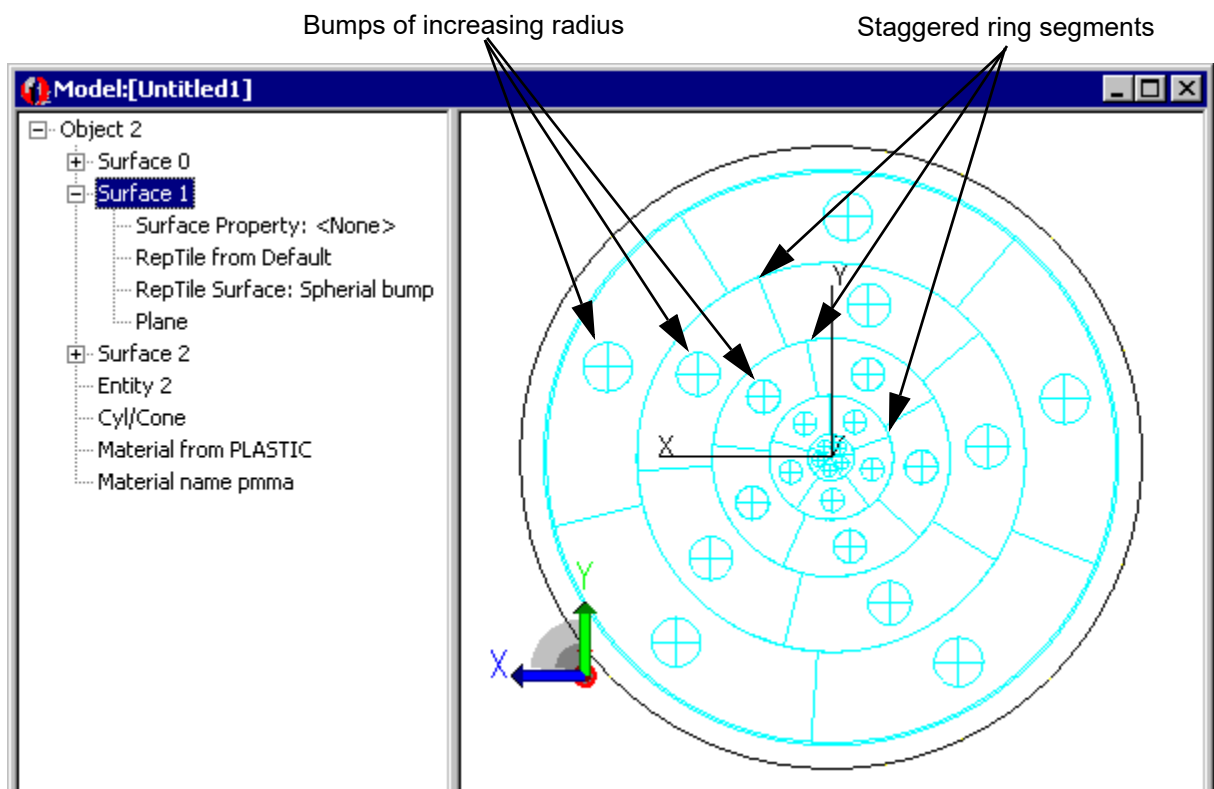

FIGURE 9.21 - Parameterized spherical bump RepTile property. The Boundary Radius is set to 11mm and the Depth to 1mm.

Now we will create the RepTile surface property.

1. Open the RepTile Property Editor by selecting **Define|EditPropertyData|RepTile Properties...**

The editor appears as in Figure 9.3 on page 9.2.

2. Click *Add Property* and enter a name, for example *Spherical bump*,
3. select *Sphere* from the *Geometry Type* drop-down list,
4. select *Rings* from the *Tile Type* drop-down list,

5. select *Parameterized* from the *Variation Type* drop-down list,
6. and click OK. See Figure 9.22.

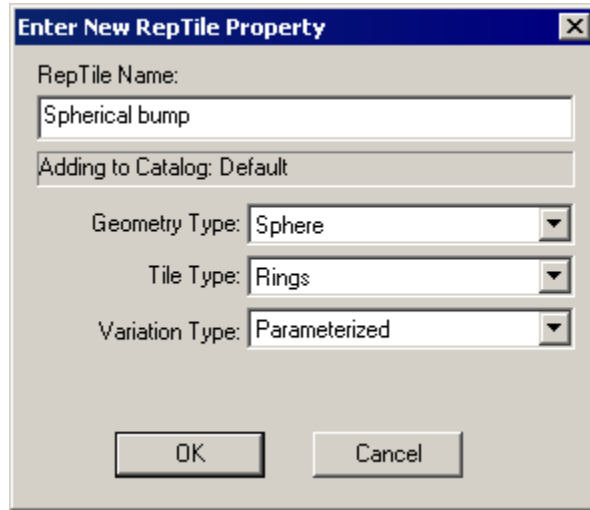

FIGURE 9.22 - Entering a parameterized RepTile property.

Now we are going to use the **Iring** variable to define the Tile Parameters and Geometry. Several of the entries will vary as a function of the ring in which the data is evaluated. See “RepTile Parameterization” on page 3.77.

Enter the functions and values shown in Figure 9.23.

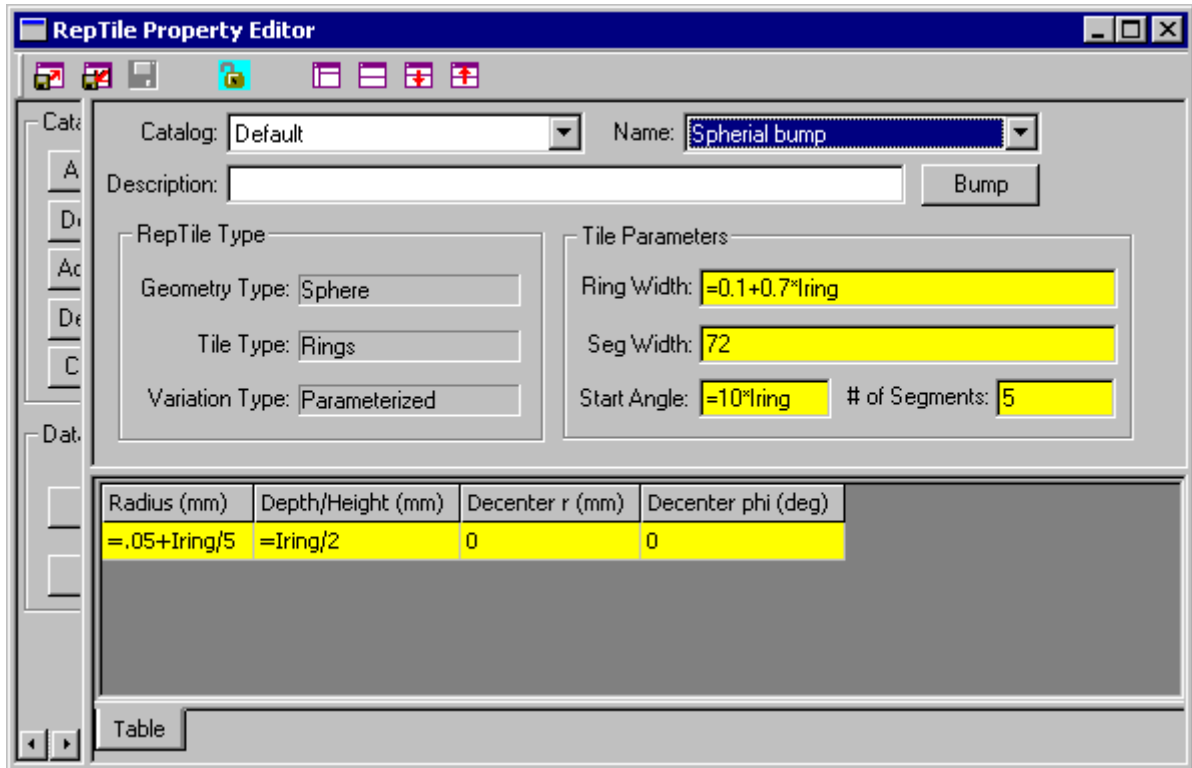

FIGURE 9.23 - Completed Spherical Bump property example.

This completes the definition of the Spherical Bump Example in the Property Editor. Close the Property Editor, and choose to save your data when the appropriate pop-up window appears.

Aperture Diffraction Example Standard Expert

In this example, we examine Fraunhofer diffraction by a circular aperture. This example illustrates how aperture diffraction works in TracePro, and how to use importance sampling with diffraction.

1. Define a source that creates a converging spherical wavefront.
 - a. Select **Geometry | Reflector** and select the Conic tab.
 - b. Insert a **Conic** reflector with the input parameters from Table 9.1.

TABLE 9.1. Data parameters for conic reflector

Shape	Spherical
Length:	100
Thickness:	1
Hole radius:	0
Radius:	1100
Origin:	X=0; Y=0; Z= -100
Rotation:	X=0; Y=0; Z=0



- c. Trim the reflector by creating a cylinder that overlaps the reflector and using the Boolean Intersect operation. Insert a cylinder with the input parameters from Table 9.2.

TABLE 9.2. Data parameters for Boolean Cylinder tool

Major R:	55
Length:	200
Base Position:	X=0; Y=0; Z=-200
Base Rotation:	X=0; Y=0; Z=0

- d. After using the Boolean Intersect operation on both objects, we need to make the reflector a Surface Source to trace rays from.
 - e. Select the inner spherical surface of the reflector (faces the +z direction) and use the **Apply Properties** dialog box to define a *Surface Source* with the input parameters from Table 9.3.

TABLE 9.3. Data parameters for Surface Source

Source Type:	Flux
Flux:	10 watts
Number of Rays:	25000
Angular Distribution:	Normal to Surface

2. Create a diffracting aperture and also an object that absorbs light that does not pass through the aperture. To do this, select **Geometry | Baffle Vane** to create a baffle vane at the origin with the input parameters from Table 9.4.

TABLE 9.4. Data parameters for Baffle Vane

Aperture Radius:	50
Tube Radius:	200
Thickness:	1
Knife Radius:	0.01
Conical angle:	0
Relative Ground Angle:	30
Position:	X=0; Y=0; Z=0
Rotation:	X=0; Y=0; Z=0



- a. Select the new baffle vane (using the Select Object tool) and apply the surface property Perfect Absorber to it (use the **Define | Apply Properties** dialog).
- b. Next, create a dummy object on which diffraction will occur. This object, a short cylinder (a disk, really) fills the aperture in the baffle vane. It is important that one end of the cylinder is coincident with the aperture in the baffle vane. In use the **Insert | Primitive Solid** dialog box and the Cylinder/ Cone tab to enter the input parameters from Table 9.5.

TABLE 9.5. Data parameters for Diffraction disk

Major R:	50
Length:	1
Base Position:	X=0; Y=0; Z=0
Base Rotation:	X=0; Y=0; Z=0

- c. Select the end surface of the cylinder that is located at $z=0$. In the **Apply Properties** dialog, select the *Diffraction* tab, check the check box, and press Apply. At this point, the model should look like the figure shown in Figure 9.24.

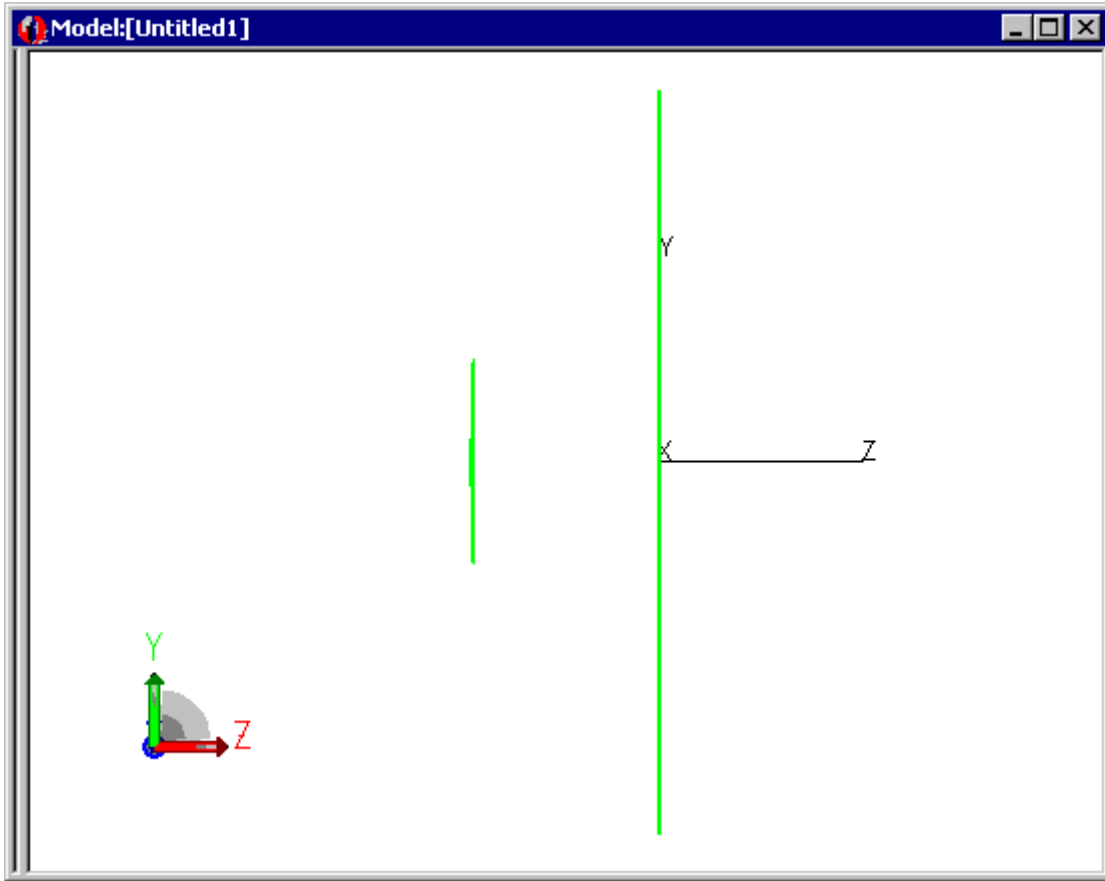

FIGURE 9.24 - The Model Window Display at the Current Step of the Example

3. Now we need an observation surface. Use the **Geometry|Primitive Solid** dialog and the **Block** tab to create a block with the input parameters from Table 9.6.

TABLE 9.6. Data parameters for Detector Block

Width:	X=1.1; Y=1.1; Z=1
Center:	X=0; Y=0; Z=1000.5

This puts the front face of the block at $z=1000$, the center of the spherical source. Make the side that faces the reflector an Exit Surface by using the Apply Properties dialog box.

4. Set up the *Raytrace Options*. Open the **Raytrace Options** dialog box (from the **Raytrace** menu) and on the *Options* tab, check Aperture Diffraction.
5. For the surface source, (Apply Properties dialog box, Surface Source selection) in the Wavelengths box, delete 0.5461 and add 10.
6. Now you are ready to trace rays and observe randomly diffracted rays. Begin a raytrace by selecting **Raytrace|Trace Rays**.

The rays that pass through the aperture are bent by diffraction. The rays are bent by a random angle according to a probability distribution. The angular width of the probability distribution depends on the location where the ray intersects the diffracting surface; the closer to the edge, the broader the distribution.

7. After the raytrace is finished, select your exit surface and create an irradiance map by selecting **Analysis | Irradiance maps**.
8. Open the Irradiance Map Options dialog box by selecting **Analysis | Irradiance Options** and set the input parameters from Table 9.3.

TABLE 9.7. Data parameters for Irradiance Map Options

Quantities to plot:	Irradiance
Rays to plot:	Incident
Normalize to emitted:	no check mark
Color Map:	Grayscale on black
Count:	256
Contours:	15
Smoothing:	checked
Logarithmic Scaling:	checked
Other options:	leave as they are

You can see in Figure 9.25 how the incident rays are most highly concentrated in the center of the map.

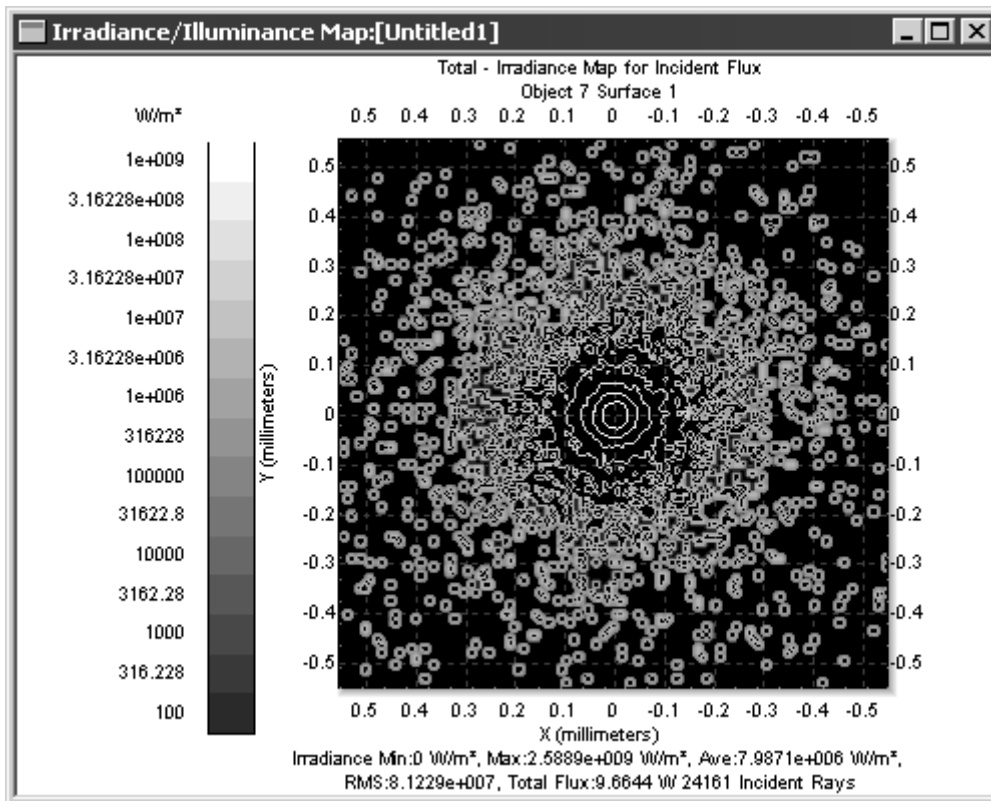

FIGURE 9.25 - Irradiance Map

Applying Importance Sampling to a Diffracting Surface

1. Select the spherical shell object and rotate it about the aperture center by a small angle, say one degree.
 - a. Select the shell object and open the Rotate dialog by selecting **Edit | Object | Rotate**.
 - b. Rotate the object about x axis and enter an angle of one degree.
 - c. Leave the rotation point at (0,0,0) and press *Apply*. That causes the spherical source to produce rays that focus at a point one degree below the observation box.
2. Redo the raytrace and irradiance map to see how this change affects the amount of light incident on the exit surface. You might see no incident rays on your exit surface.
3. Make an importance sampling target for the diffraction surface that is coincident with the Exit Surface forces TracePro to trace a ray onto the exit surface.
 - a. To apply importance sampling to the diffracting surface, first select the diffracting surface (the one lying in the z=0 plane), and open the Apply Properties dialog. Select the Importance Sampling tab, then press the *Add* button to make a target with the following properties:

Target:	1
Rays:	1
Direction:	Toward
Shape:	Rectangular
Target Center:	X = 0.0; X = 0.0; Z = 1000
Normal Vector:	X = 0.0; X = 0.0; Z = 1.0
Up Vector:	X = 0.0; X = 1.0; Z = 0.0
Target Size:	X width = 1.0; Y width = 1.0

- b. Click *Apply*. These properties have defined the exit surface as an importance target of the diffracting surface.
4. Close the Apply Properties dialog box and open the **Analysis | Raytrace Options** dialog box.
 - a. On the Thresholds tab, set the Flux Threshold to 1e-50. You must use a lower threshold because importance sampling “forces” a Monte Carlo raytrace (which is normally random) to place a ray in a particular direction. As a result, the flux of the rays that strike the importance target need to be adjusted for the probability of such a ray occurring.
5. Re-run the raytrace and observe importance sampled rays striking the observation square. The irradiance map below represents one possible result

of this raytrace:

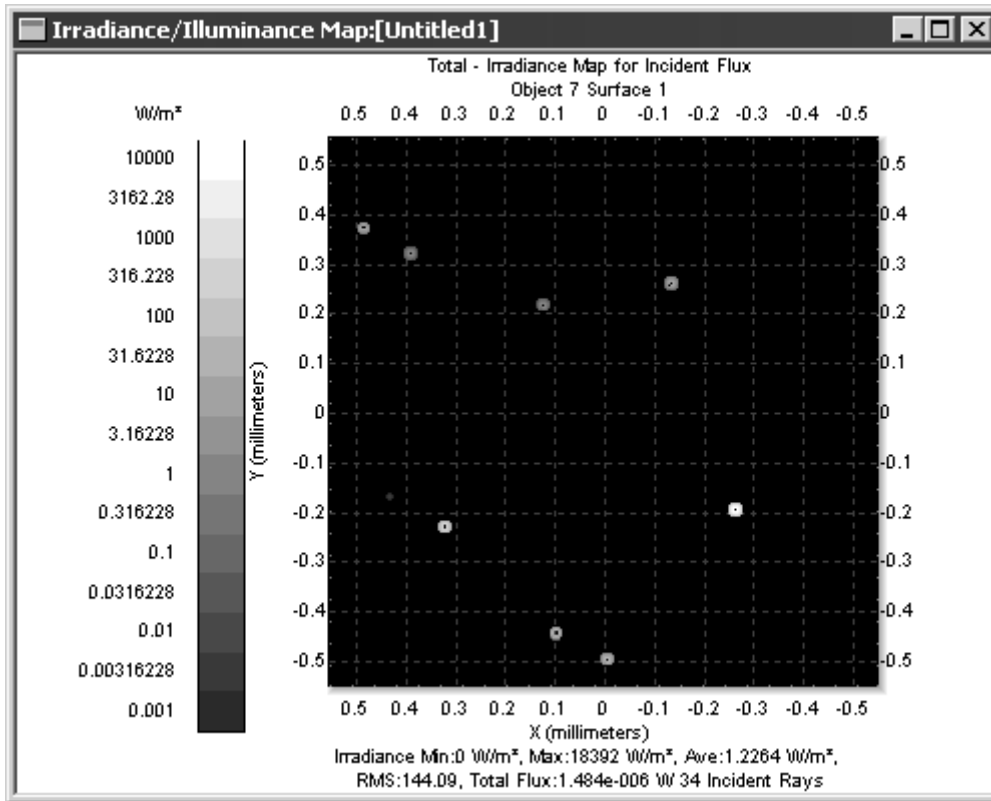

FIGURE 9.26 - Irradiance Map for Edge Diffraction with Importance Sampling

6. Rotate the source object about the x axis by one more degree, with the origin at (0,0,0) as the rotation point.
7. Re-run the raytrace and observe lower flux at the observation surface.

Volume Flux Calculations Example Standard Expert

To illustrate the volume flux calculation capabilities in TracePro, a simple example will be described which entails tracing numerous rays into a block which has bulk absorption and bulk scattering properties.

An illustration of a raytrace with 1000 rays traced into this block is shown in Figure 9.27.

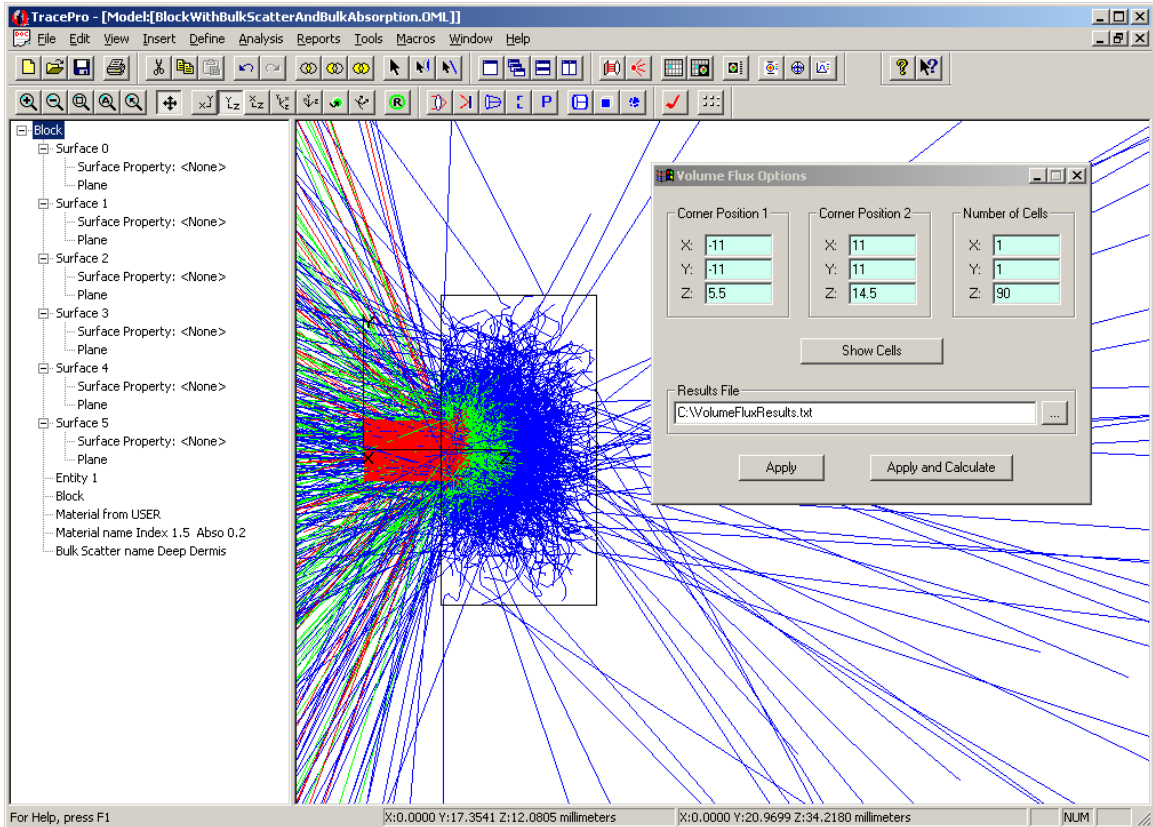

FIGURE 9.27 - Example of a raytrace into a block object that has bulk absorption and scattering properties. The Volume Flux Options window is open, but the volume flux cells are not shown in the model.

By selecting the “Show Cells” button, we can view the cells involved in the calculation. This is shown in Figure 9.28.

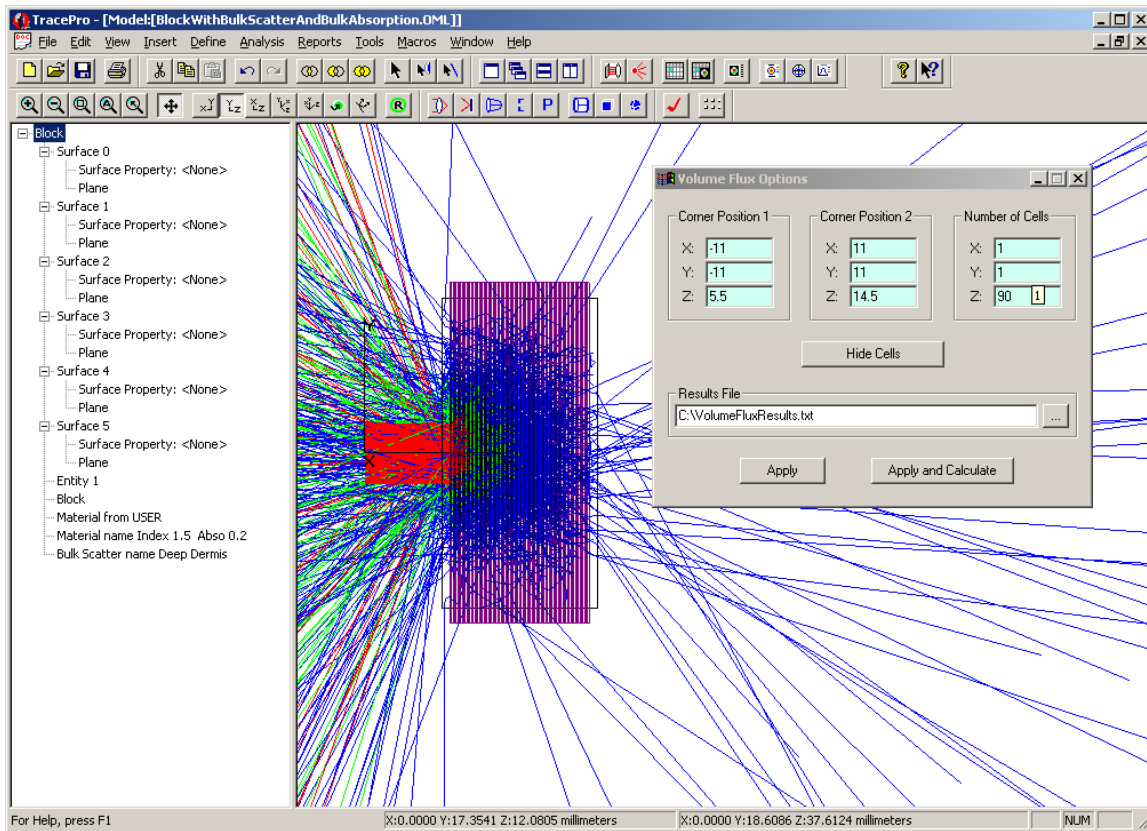

FIGURE 9.28 - Example of a raytrace into a block object that has bulk absorption and scattering properties. The cells used in the calculation of volume flux are now shown in the model window.

The modeled object is a block that extends in Z from 5mm to 15mm. The purpose of this calculation is to obtain an absorption profile into the block (along the z-axis) from a penetration depth of 0.5mm and beyond. To perform this, we input the corner positions and number of cells as shown above. We have selected 90 cells in the Z direction which spans 9.0mm, hence our spatial resolution in Z is 0.1mm.

In order to get good sampling we need to trace many rays. But, the more rays we trace, the more memory we will need. However, with the implementation of the volume flux calculations, and the TracePro macro language concatenating analyses, we can trace many rays with a small amount of memory.

To support volume flux calculations, the following nine macro commands have been added to TracePro:

To set the user input values:

- (analysis:set-volume-flux-corner-1 (position X Y Z))
- (analysis:set-volume-flux-corner-2 (position X Y Z))
- (analysis:set-volume-flux-cells NUM_X NUM_Y NUM_Z)
- (analysis:set-volume-flux-results-filename FILENAME)

To retrieve the user input values:

```
(analysis:get-volume-flux-corner-1)
(analysis:get-volume-flux-corner-2)
(analysis:get-volume-flux-cells)
(analysis:get-volume-flux-results-filename)
```

To perform the volume flux calculations:

```
(analysis:volume-flux)
```

The scheme macro outlined in Figure 9.29 was used to perform repeated raytraces. The random number seed was changed before each raytrace, ensuring a different set of rays. At the conclusion of the raytrace, the volume flux calculations were updated.

```

1 (define run-volume-flux
2   (lambda ()
3     (raytrace:set-grid-pattern-random 1000 0.001)
4     (raytrace:set-volume-flux-corner-1 (position -11 -11 5.5))
5     (raytrace:set-volume-flux-corner-2 (position 11 11 14.5))
6     (analysis:set-volume-flux cells 1 1 90)
7     (analysis:set-volume-flux-results-filename "C:/VolumeFluxResults.out")
8     (do((iCount 1 (+iCount 1)))
9       ((> iCount 1000000) iCount)
10      (print iCount)
11      (raytrace:grid)
12      (raytrace:set-random-seed (+1 (raytrace:get-random-seed)))
13      (analysis:volume-flux)
14    )
15  ))

```

FIGURE 9.29 - Example Scheme macro used to perform repeated raytraces and volume flux calculations.

From the scheme macro, entitled (run-volume-flux), we can see the terminating condition for the do-loop has been set to some arbitrarily large number (1,000,000 in this case). We let the simulation run until the counter reached 18,000. Since each raytrace consisted of 1000 rays, the total ray count for this simulation was 18,000,000. More importantly, however, the memory requirements were that for only a single trace – 1000 rays in this case.

The output file was opened in Microsoft Excel and the results were graphed in Figure 9.30. Notice the extremely smooth distribution of absorbed flux and

cumulative absorbed flux. This can be attributed to the large number of rays being traced, hence the sampling error has been substantially reduced.

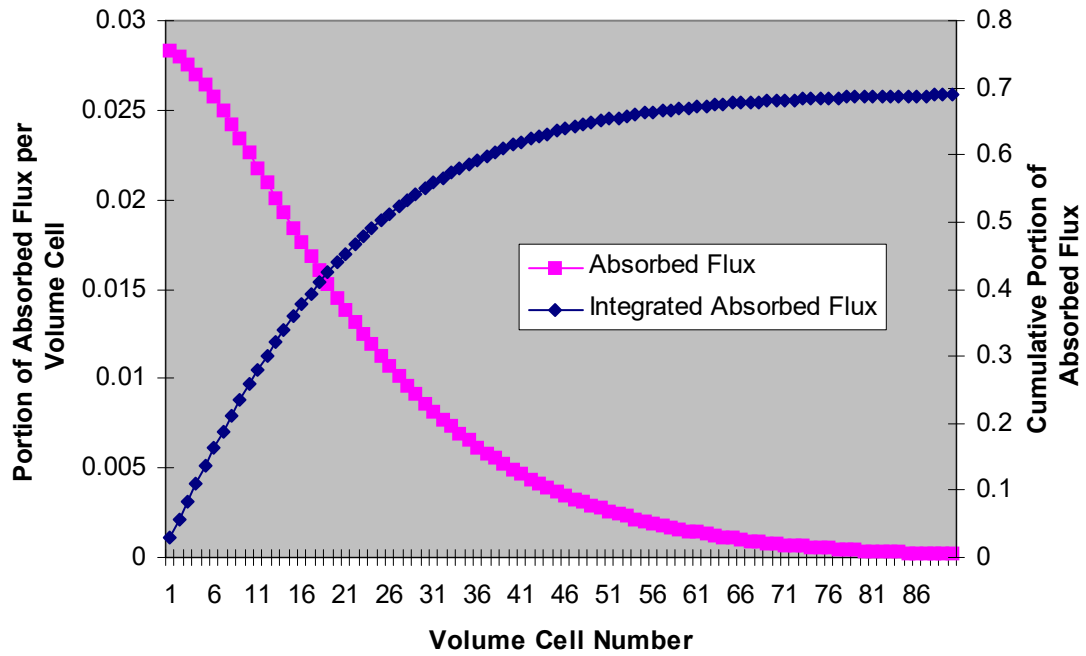

FIGURE 9.30 - Volume Flux Calculations from TracePro

Sweep Surface Example

In this example you will create a solid cylinder, lengthen it, and then put a conical end on it.

1. Create the cylinder by selecting **Geometry|Primitive Solid** and selecting the Cylinder/Cone tab. Enter the following values for the Cylinder and then press Insert:
2. Major Radius: 10
3. Length: 50
4. Base Position: 0, 0, 0
5. Select **View|Profiles|Iso 1** to get the view shown in Figure 9.31.

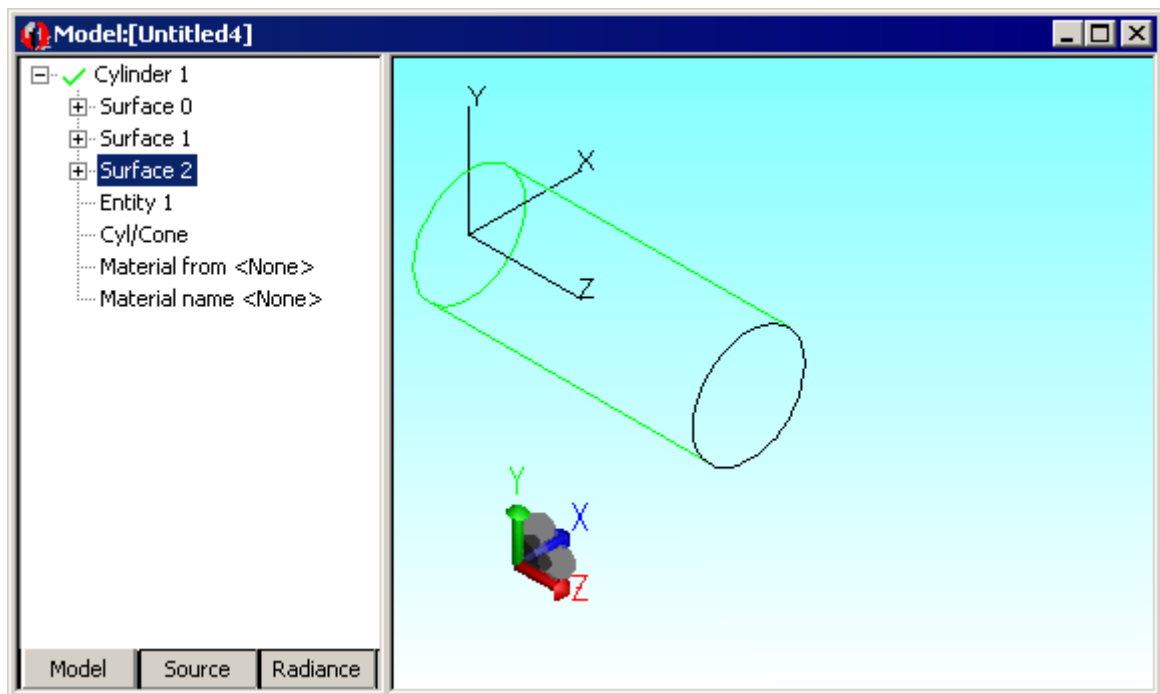

FIGURE 9.31 - Cylinder

To lengthen the cylinder, first select **Edit|Select Surface** to turn on surface selection mode and select the +z end plane of the cylinder. Then select **Edit|Surface|Sweep** to open the Sweep Surface Selection dialog box and enter the values as shown in Figure 9.32.

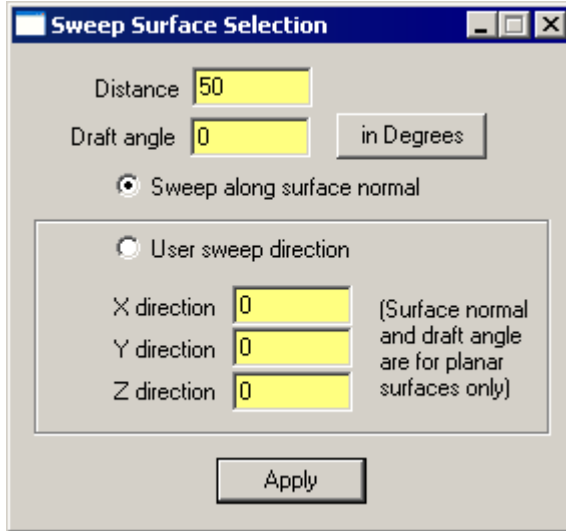

FIGURE 9.32 - Sweep Surface Dialog Box

Press Apply to sweep the surface. The planar end surface of the cylinder will be swept along the normal to the plane (i.e., along the +z axis) by 50 as shown in Figure 9.33:

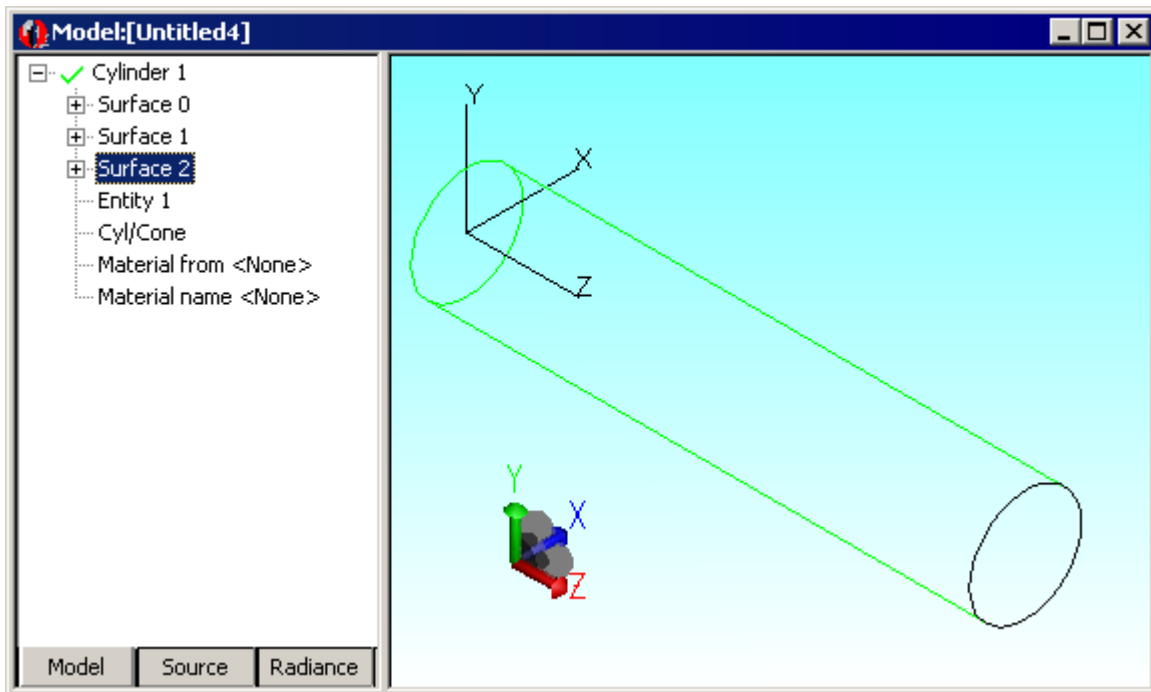

FIGURE 9.33 - Extended Planar Surface After a Surface Sweep

Now change the Distance to 10 and Draft angle to -30 as shown in Figure 9.34. The optional draft-angle is specified in degrees. If the normal to the plane of the surface is in the same direction as the tangent at the start of the path, the surface profile is expanded for positive draft angles, or contracted for negative draft

angles as it is swept along the path; otherwise, it is contracted for positive angles, and expanded for negative angles.

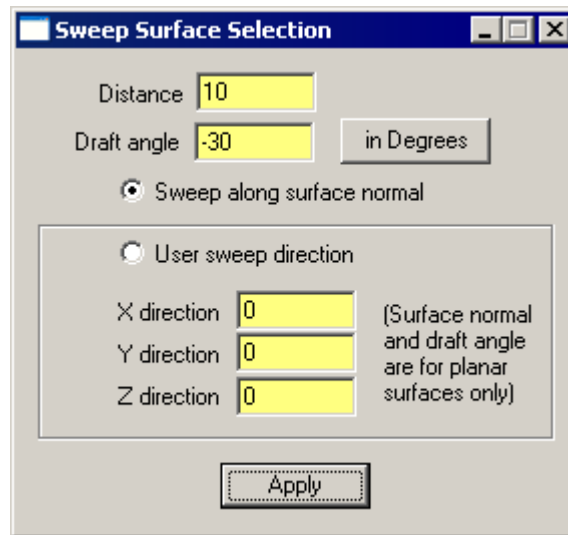

FIGURE 9.34 - Sweep Surface With A Negative Draft Angle

Press Apply to sweep the surface with a negative draft angle of thirty degrees. This creates a conical extension on the end face with a conical half-angle of 30 degrees, as shown in Figure 9.35.

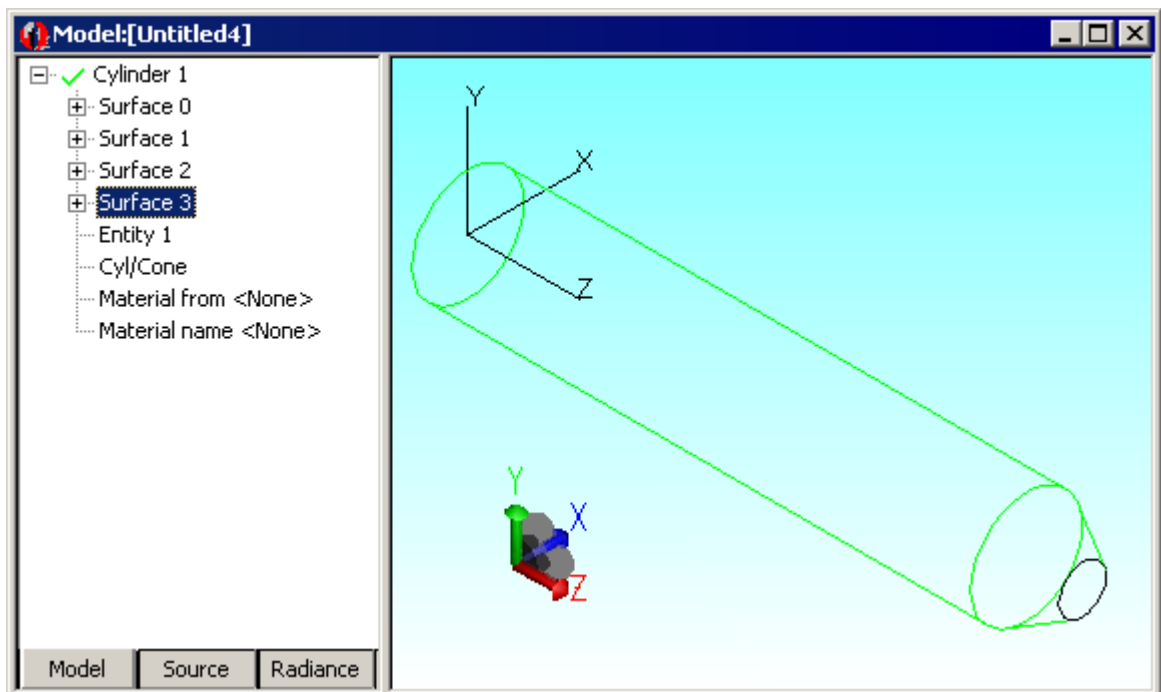

FIGURE 9.35 - The Result of the Negative Draft Angle

Revolve Surface Example

In this example you will create a solid cylinder, then revolve the end with a negative draft to create a horn-shaped bend.

1. Create the cylinder by selecting **Geometry|Primitive Solid** and selecting the Cylinder/Cone tab.
2. Enter the following values for the cylinder and press Insert to create the object:
3. Major Radius: 10
4. Length: 50
5. Base Position: 0, 0, 0
6. Select **View|Profiles|Iso 1** to get an oblique view.
7. To bend and taper the cylinder, first select **Edit|Select Surface** to turn on surface selection mode and select the +z end plane of the cylinder.
8. Then select **Edit|Surface|Revolve** to open the Revolve Surface Selection dialog box and enter the values as shown in Figure 9.36.
9. Click the option "Calculate a position using the selected surface" to get the Position information.
10. Click *Revolve Surface*. The face will be revolved and tapered as shown in Figure 9.37.

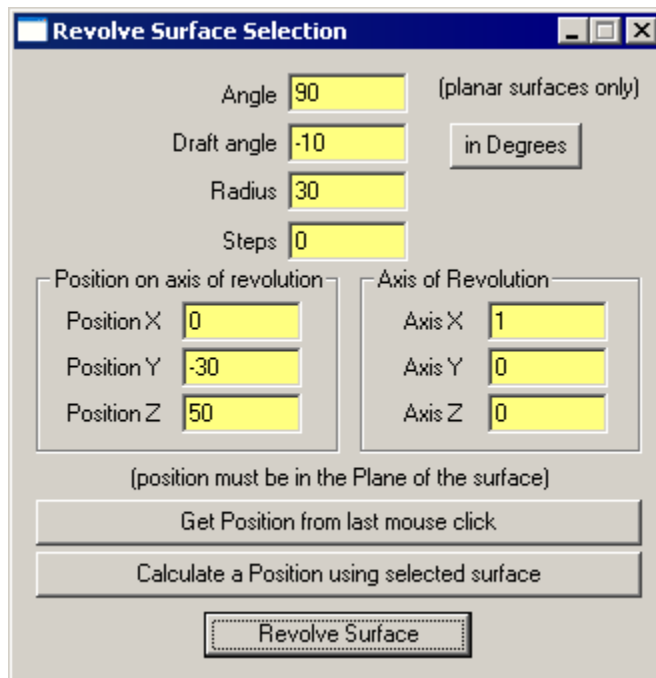

FIGURE 9.36 - The Revolve Surface Selection Dialog Box

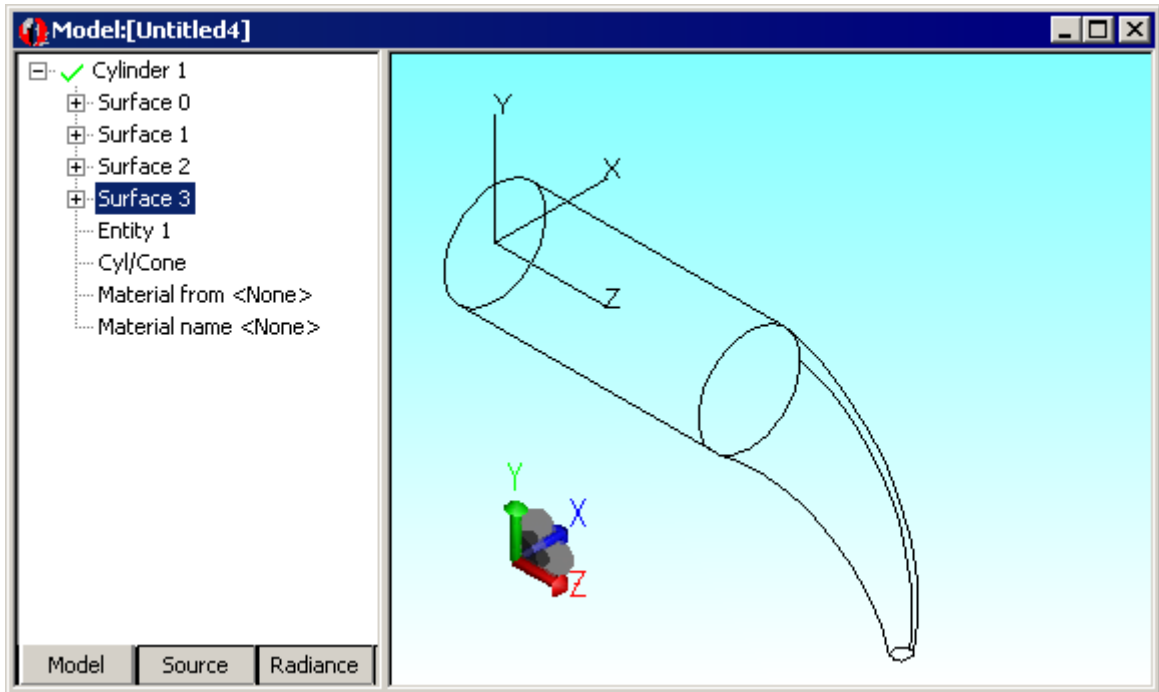

FIGURE 9.37 - The Result of the Values in the Dialog Box

To see how a non-zero Step value affects the revolve function, first select **Edit | Undo** (or press the Undo button) to undo the previous revolve. Now change the Draft angle to zero, and the Steps value to 1. Press Revolve Surface to see the mitered corner appear on the cylinder as shown in Figure 9.38.

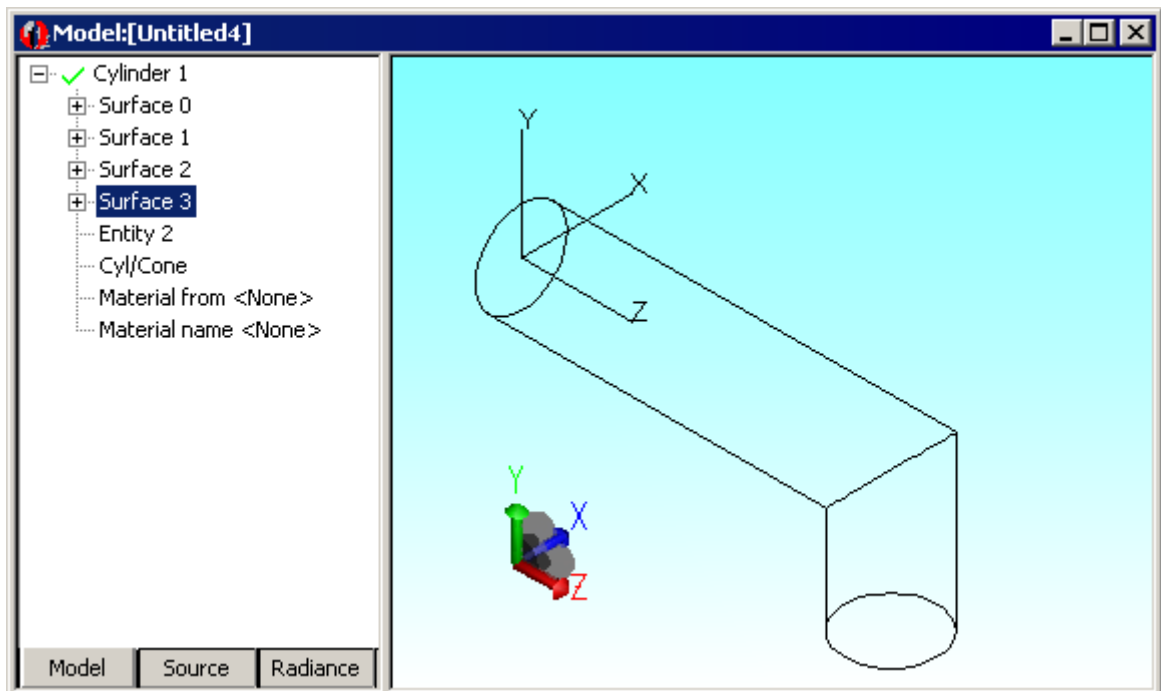

FIGURE 9.38 - Result with Draft Angle Zero & Step Value 1

Using Copy with Move/Rotate

TracePro can be used to create arrays of objects through the **Edit | Move** and **Edit | Rotate** dialogs. One or more objects may be duplicated from a reference object. The geometry and TracePro properties will be transferred to the duplicated object.

This example will demonstrate a method to create a linear and rotational lens array. Arrays of reflecting objects may be created in TracePro RC using this example as a template.

1. Create a lens by selecting **Geometry | Lens Element**.
2. Enter the following values for the cylinder and press **Insert** to create the object:
3. Thickness: 3
4. Surface 1 Radius: 12

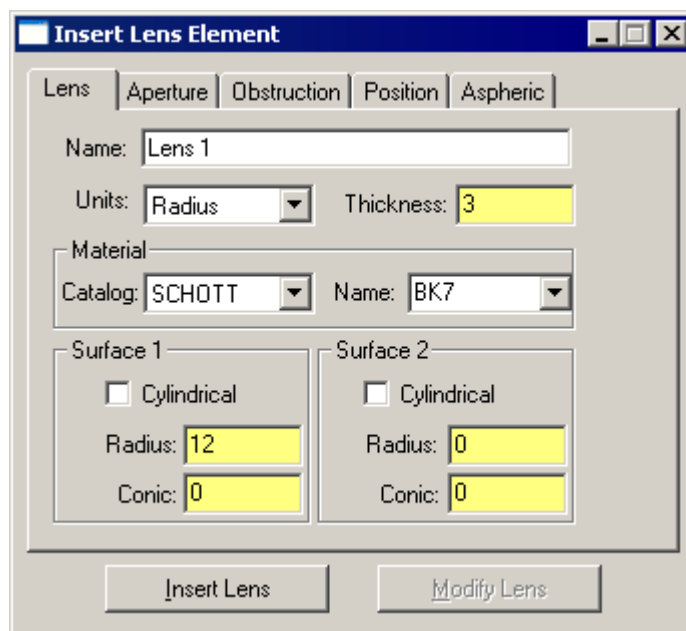

FIGURE 9.39 - Lens Element Dialog

5. Trace a fan of rays by setting the parameters of the **Define | Grid Source** to an Outer radius of 25, Grid Pattern to Cross, and X points to 1. The other options may be set to the default values.
6. Trace the rays by pressing the *Trace This Rays* button. See Figure 9.40.
7. Open the **Edit | Move** dialog.
8. Select the Lens by pressing **Edit | Select | Object** and clicking on the lens with the mouse.
9. Create a second lens by entering 16 for Y Center in the Move Selection Dialog. Press the *Copy* button. See Figure 9.41.
10. Create a third lens by entering -32 for the Y Center in the Move Selection Dialog. Press the *Copy* button. Notice that the selection move from the first to second and then third object.
11. Trace another grid raytrace. See Figure 9.42.

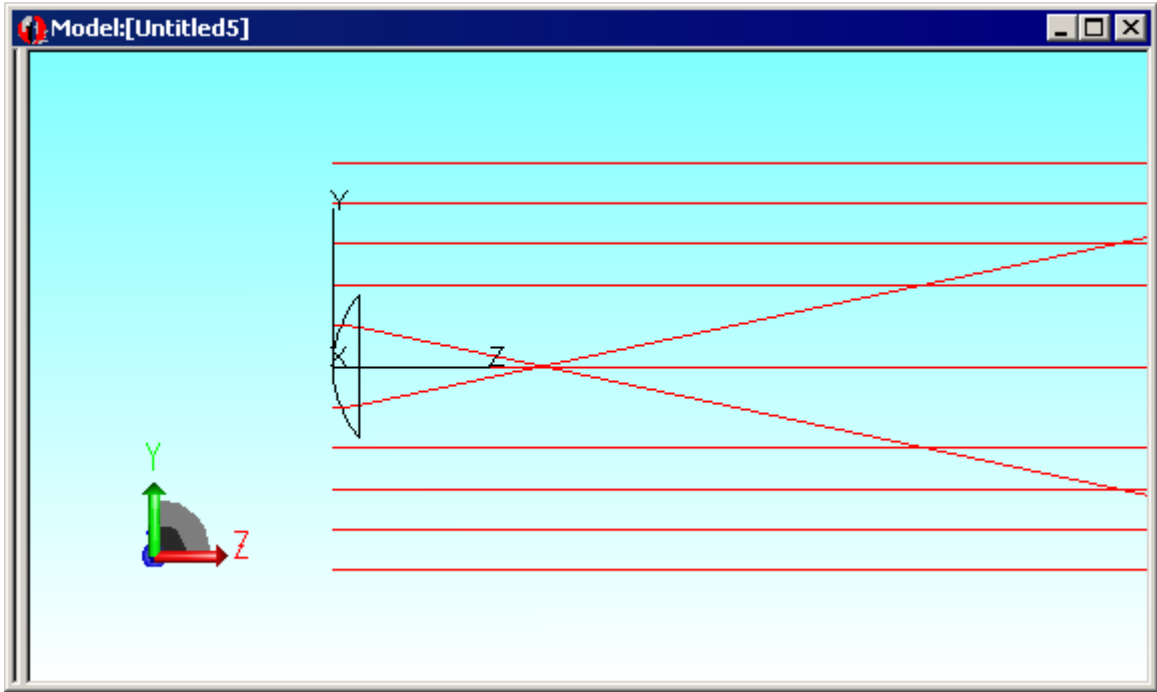

FIGURE 9.40 - Raytrace of single lens element

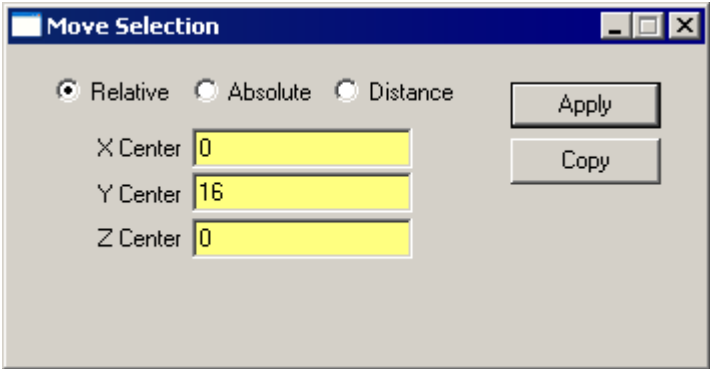

FIGURE 9.41 - Move Selection Dialog

- 12. Next create the rotational arrays by changing the TracePro view to a XY profile by selection **View|Profile|XY**.
- 13. If the bottom lens is not highlighted, select the bottom lens. See Figure 9.43.
- 14. Open the **Edit|Object|Rotate** dialog.
- 15. Enter 60 for Rotation Angle and change the Axis to About Z. See Figure 9.44.
- 16. Press the Copy button twice to create two more lenses.
- 17. Skip the top lens by changing the Rotation Angle to 120, press *Copy*.
- 18. Add one more lens by returning the Rotation Angle to 60 and press *Copy*.
- 19. The resulting Lens Array is shown in Figure 9.45.

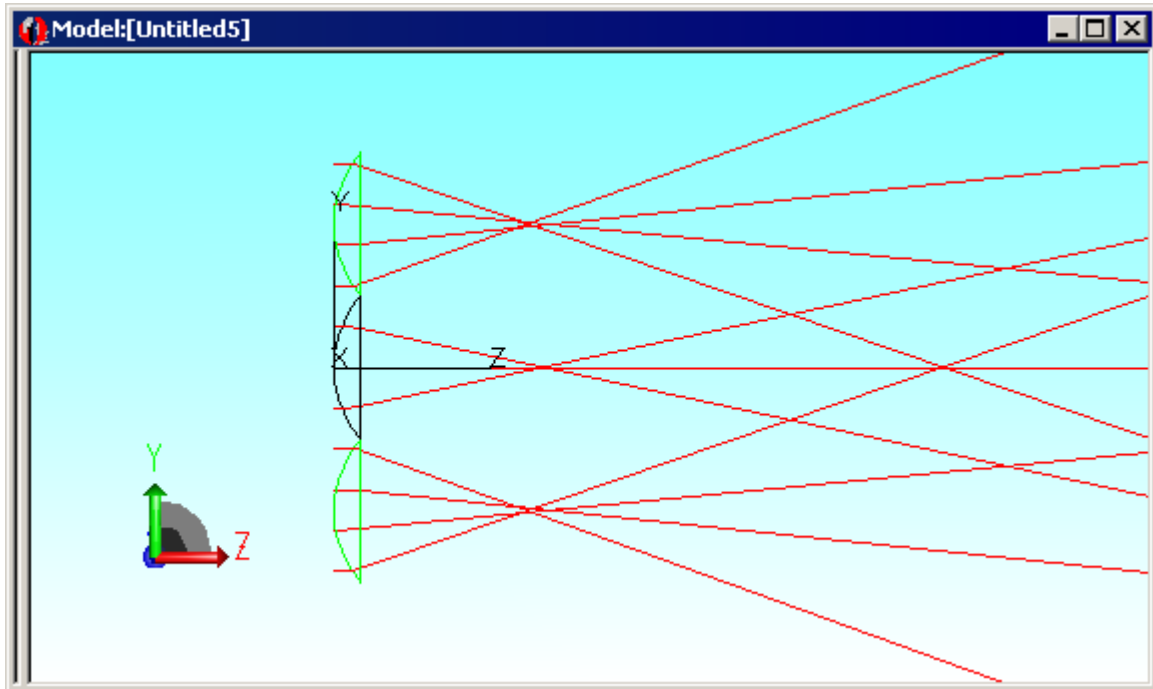

FIGURE 9.42 - Raytrace of linear lens array

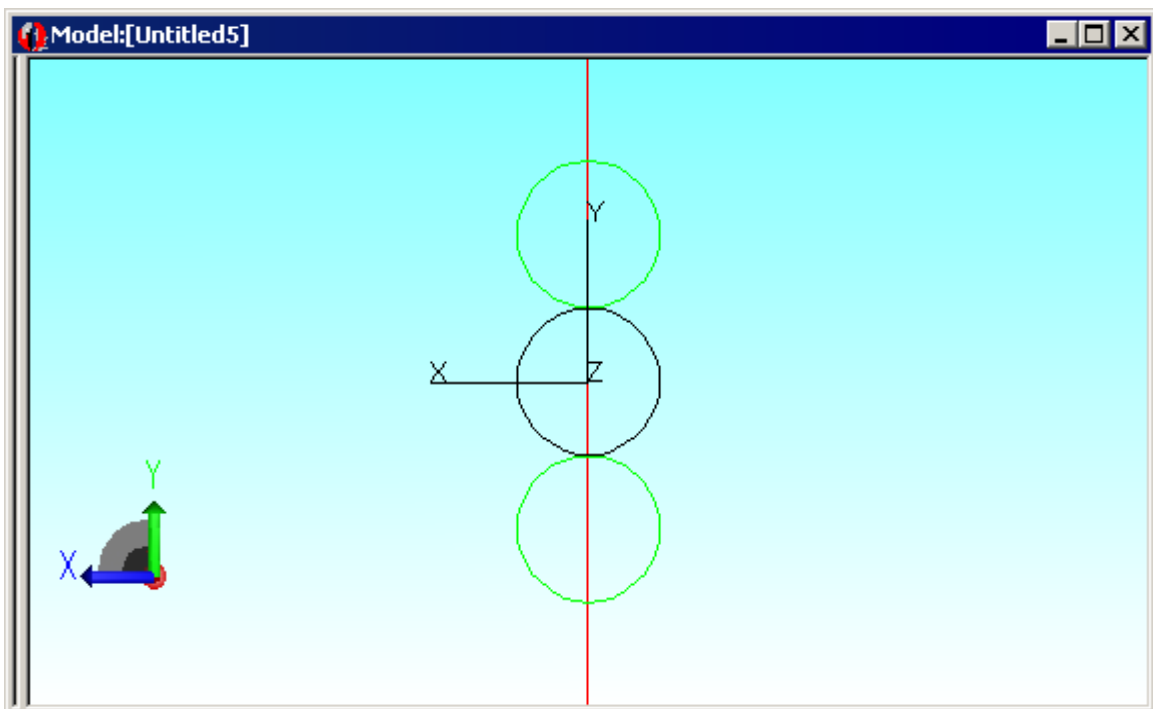

FIGURE 9.43 - XY Profile of Linear Lens Array.

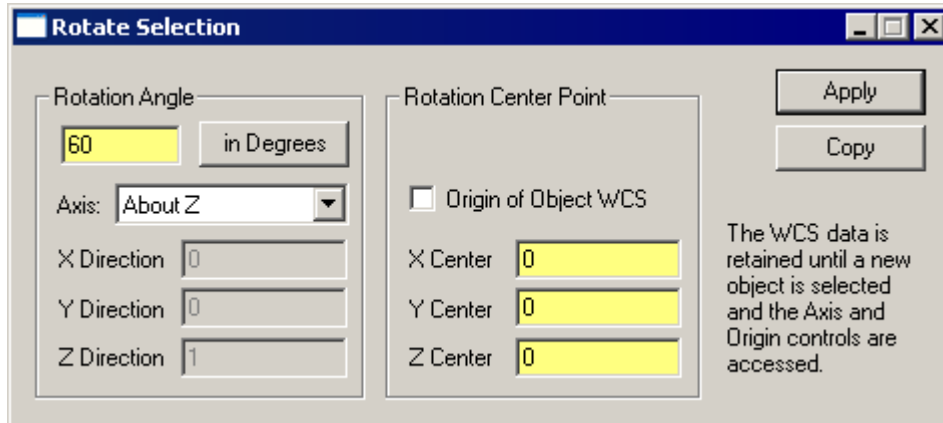

FIGURE 9.44 - Rotate Selection Dialog

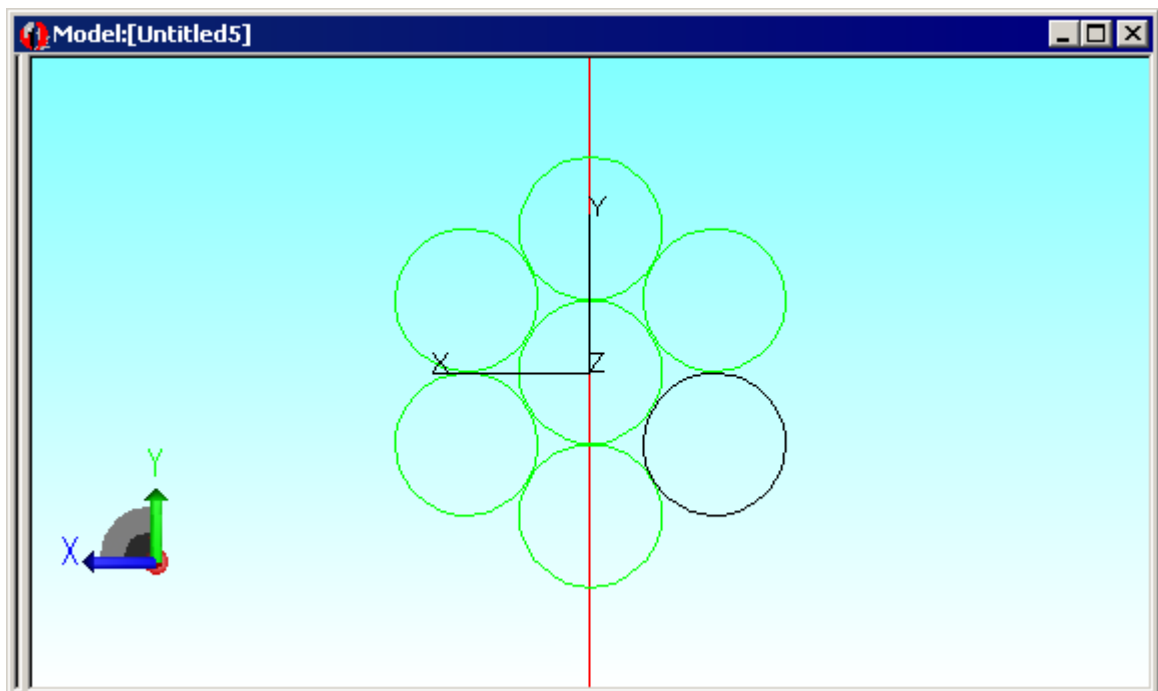

FIGURE 9.45 - Rotation Lens Array

Anisotropic Surface Property

The anisotropic surface property is used like any other surface property, except that actual values of the property needed for ray-tracing or surface sources are calculated by bilinear interpolation from the data points you enter. You can apply an anisotropic surface property to any surface in the model and it will be used in the usual way.

Creating an anisotropic surface property in TracePro

Creating an anisotropic surface property is much like creating a Table surface property. Select **Define | Edit PropertyData | Surface Properties** to open the Surface Property Editor. Select the catalog in which you wish to create the new property from the Catalog drop-down list. Click the *Add Property* button, and select the Scatter Model you wish, and enter Temperature and Wavelength. The Surface Property Editor will create a new property of type Table. Finally, select Anisotropic from the Type drop-down list. The figure below shows the editor after changing to type Anisotropic. This example property was created with ABg scatter model selected in the Add Property dialog box.

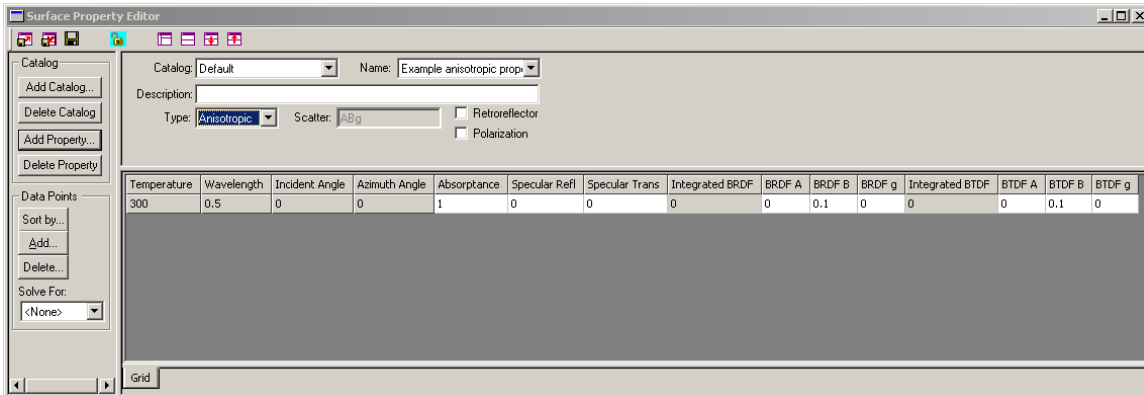

You can add as many Incident Angles and Azimuth Angles as you wish. To add more angles, click the Add button in the Data Points part of the Surface Property Editor. The figure below shows the property with three Incident Angles and four Azimuth Angles. Enter angles in degrees.

Temperature	Wavelength	Incident Angle	Azimuth Angle	Absorptance	Specular Refl	Specular Trans	Integrated BRDF	BRDF A	BRDF B	BRDF g	Integrated BTDF	BTDF A	BTDF B	BTDF g
300	0.5	0	0	1	0	0	0	0	0.1	0	0	0	0.1	0
300	0.5	0	90	1	0	0	0	0	0.1	0	0	0	0.1	0
300	0.5	0	180	1	0	0	0	0	0.1	0	0	0	0.1	0
300	0.5	0	270	1	0	0	0	0	0.1	0	0	0	0.1	0
300	0.5	45	0	1	0	0	0	0	0.1	0	0	0	0.1	0
300	0.5	45	90	1	0	0	0	0	0.1	0	0	0	0.1	0
300	0.5	45	180	1	0	0	0	0	0.1	0	0	0	0.1	0
300	0.5	45	270	1	0	0	0	0	0.1	0	0	0	0.1	0
300	0.5	90	0	1	0	0	0	0	0.1	0	0	0	0.1	0
300	0.5	90	90	1	0	0	0	0	0.1	0	0	0	0.1	0
300	0.5	90	180	1	0	0	0	0	0.1	0	0	0	0.1	0
300	0.5	90	270	1	0	0	0	0	0.1	0	0	0	0.1	0

Note that for rows in which the Incident Angle is zero, only one of the rows is editable (the azimuth=0 row) and the others are “grayed out.” This is because the azimuth angles have no meaning if the light is incident at zero degrees. When you enter values for the zero incident angle, zero azimuth angle row, the other zero-incidence rows will update with the same data.

Applying an anisotropic surface property to a surface

To apply an anisotropic surface property to a surface, select the surface(s) to which you wish to apply the property. Select **Define | Apply Properties** and click the Surface tab. Select the property catalog and name from the lists. Next, within the Surface tab, select the Anisotropic Axis tab and enter the direction for the *Zero Azimuth Direction*. Note that this direction vector is also used for orienting the

elliptical BSDF, if present. An example is shown below with (1, 0, 0) entered for the azimuth = 0 axis.

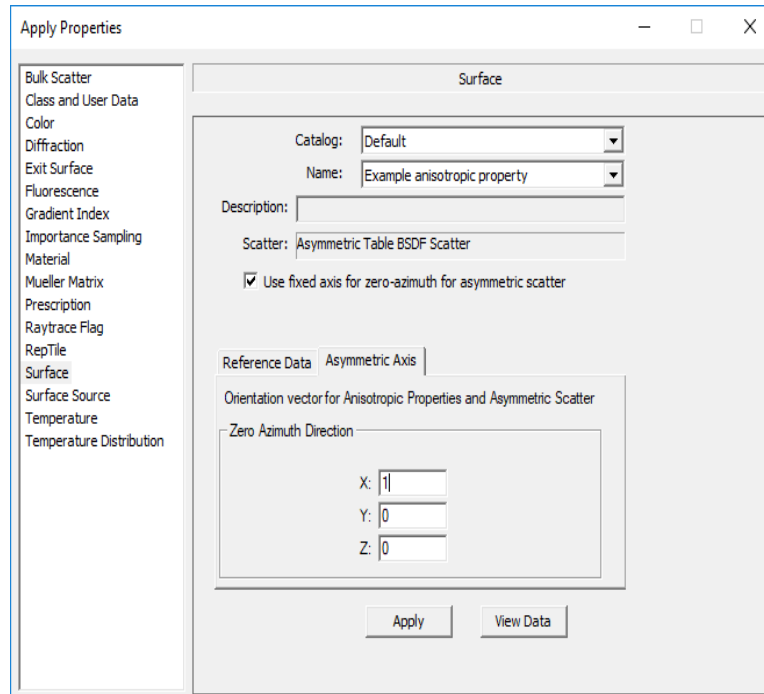

FIGURE 9.46 - Anisotropic Axis Sub-Tab in Apply Properties Dialog

The *Zero Azimuth Direction* need not lie in the surface, as TracePro will project it onto the surface. For a curved surface, it will not be possible for it to lie in the tangent plane of the surface in general anyway. If you are applying the property to a plane surface, the *Zero Azimuth Direction* must not be perpendicular to the surface. Finally, click the Apply button to apply the property to the selection.

Elliptical BSDF

Elliptical BSDF refers to two anisotropic scatter models which may be used in conjunction with any surface property type. Each model is defined by a major and minor axis, hence the elliptical name. The data can be defined using ABg or Gaussian coefficients.

An elliptical BSDF surface property is used like any other surface property, except that when you apply the property to a surface, you must specify the azimuth=0 axis in the Apply Properties dialog. This is found on the Anisotropic Axis sub-tab of the surface property tab.

Creating an Elliptical BSDF property

Select **Define|Edit PropertyData|Surface Properties** to open the Surface Property Editor. Select the catalog in which you wish to create the new property from the Catalog drop-down list. Click the *Add Property* button, and select the Scatter Model you wish to use, either Elliptical ABg or Elliptical Gaussian, and enter Temperature and Wavelength. The Surface Property Editor will create a new

Examples

property of type Table. Finally, select whatever Type of surface property from the drop-down list. The figure below shows the editor with Elliptical ABg selected and after changing to type Anisotropic.

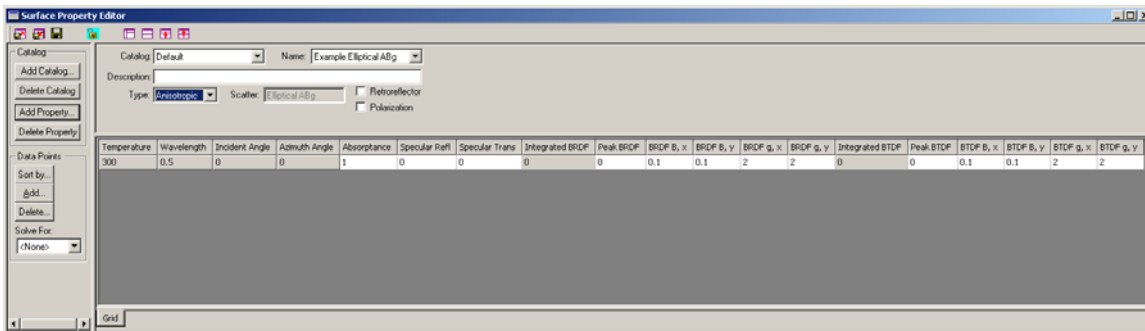

Applying an elliptical BSDF surface property to a surface

To apply an elliptical BSDF surface property to a surface, select the surface(s) to which you wish to apply the property. Select **Defi ne | Appl y Propert i es** and click the Surface tab. Select the property catalog and name from the lists. Next, within the Surface tab, select the Anisotropic Axis tab and enter the direction for the *Zero Azimuth Direction*. Note that this direction vector is also used for orienting the surface property if it is anisotropic. An example is shown in Figure 9.46 with (1, 0, 0) entered for the *Zero Azimuth Direction*.

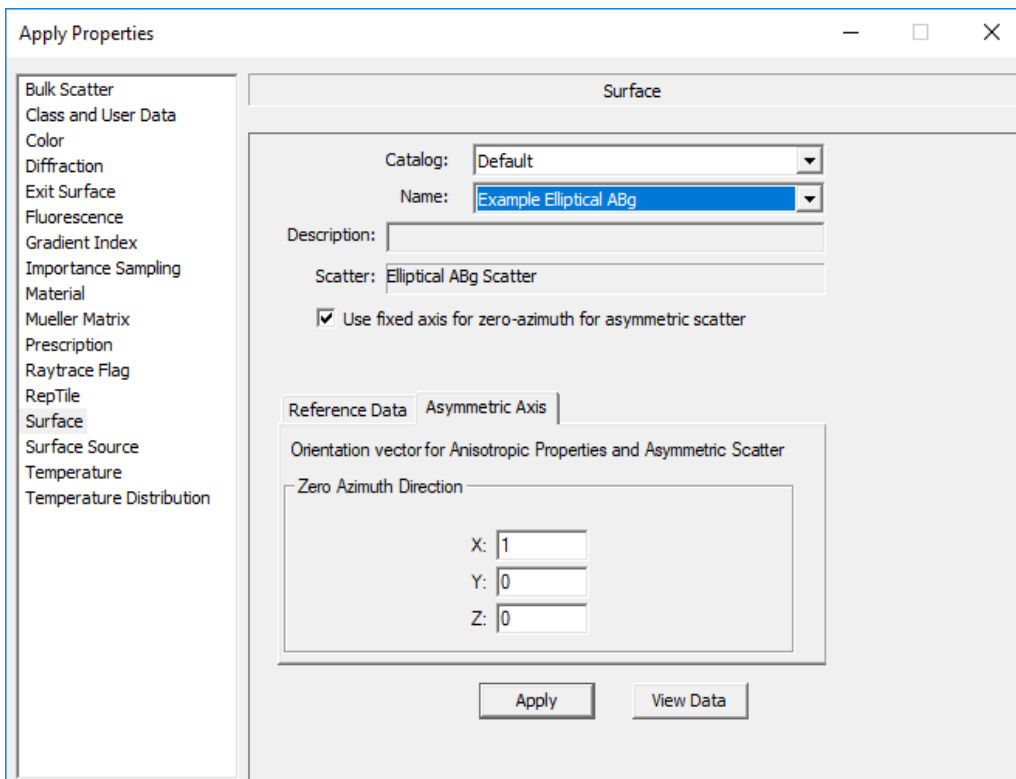

The azimuth = 0 axis need not lie in the surface tangent plane, as TracePro will project it onto the surface. For a curved surface, it will not be possible for it to lie in the tangent plane of the surface in general anyway. If you are applying the property to a plane surface, the azimuth = 0 direction must not be perpendicular to the surface. Finally, click the Apply button to apply the property to the selection.

Using TracePro Diffraction Gratings

Modeling of diffraction gratings has been added as a new feature to TracePro. You can model linear gratings using this feature. This means that the grating grooves are along the intersections of equally spaced parallel planes with a substrate surface. The substrate surface may be a plane, in which case the grating grooves are equally spaced and straight. If the substrate is curved, the grating grooves are defined by the intersection of equally spaced parallel planes with the substrate.

Gratings of this type are made by a ruling engine, where with each pass the tool is advanced by the same distance, and the tool is able to follow the contours of the surface.

Using Diffraction Gratings in TracePro

To use a diffraction grating in TracePro, you must first define a surface property that is of type grating, specify the diffraction efficiency of each order in the property, then apply the property to a surface.

To define a grating surface property:

1. First create a new surface property with the ABg scatter model. See “Editing an Existing Surface Property” on page 3.29.
2. From the Type drop-down list, choose Grating as shown in Figure 9.47.

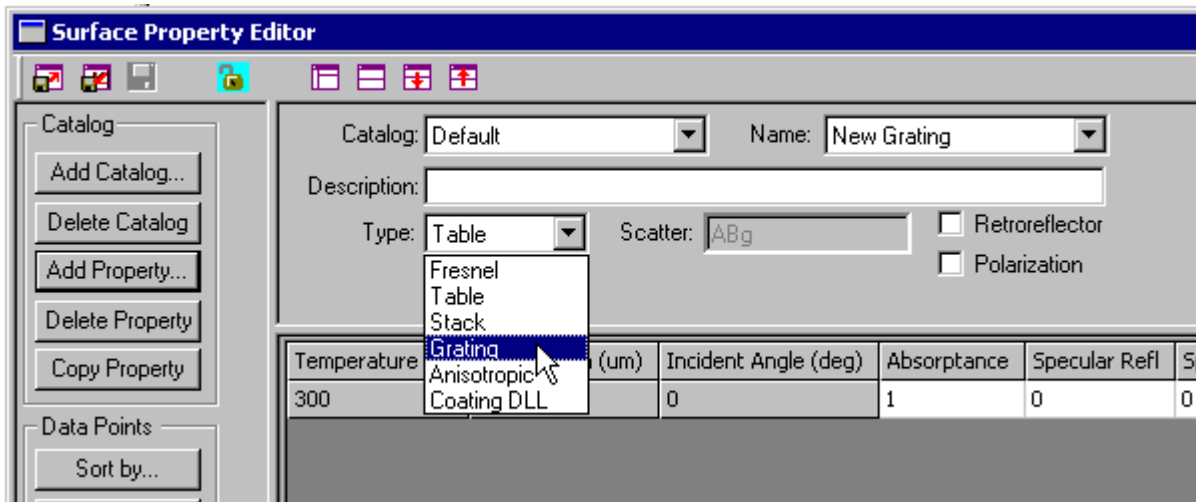

FIGURE 9.47 - Creating a surface property of type Grating.

3. Add new diffracted orders by clicking Add in the Data Points section.
4. Enter the diffraction order and efficiency for both reflected and transmitted orders. You can add as many orders as you wish by typing in new orders in the *Add* dialog box and clicking *Apply* after each one as shown in Figure 9.48.

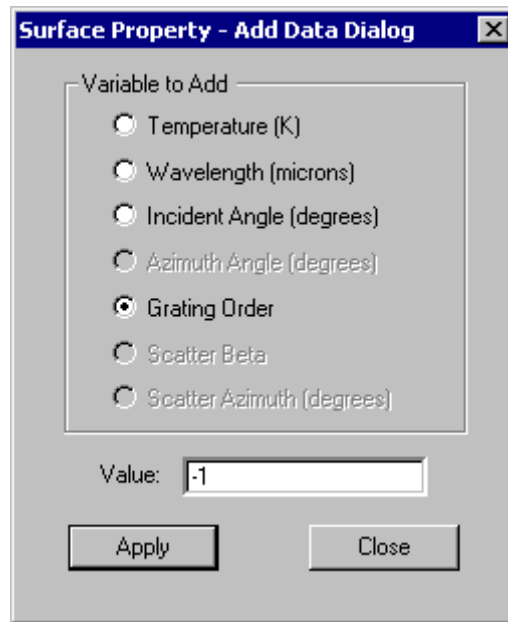

FIGURE 9.48 - Adding a grating order using the Add Data dialog box.

The efficiency is the fraction of the incident flux that is diffracted into that order. TracePro computes the sum of all the reflection efficiencies and puts that value in the *Total* row on the bottom of the input for the current data subset, and likewise for the transmission efficiencies. For a Grating surface property, then, you cannot enter the specular reflectance and transmittance in the usual way. You may, however, enter the absorptance, BRDF, and BTDF in the usual way, and you may solve for the absorptance, BRDF, or BTDF. You may also enter as many angles of incidence as you wish, the same as for a Table type of surface property.

5. Finally, you must enter the grating spacing. This is the distance between the parallel planes used to form the grating.

The illustration below shows a completed grating surface property with one angle of incidence and three grating orders. In this example, we defined the BRDF with $A = 0.002$, $B = 0.001$, and $g = 2$, then solved for Absorptance.

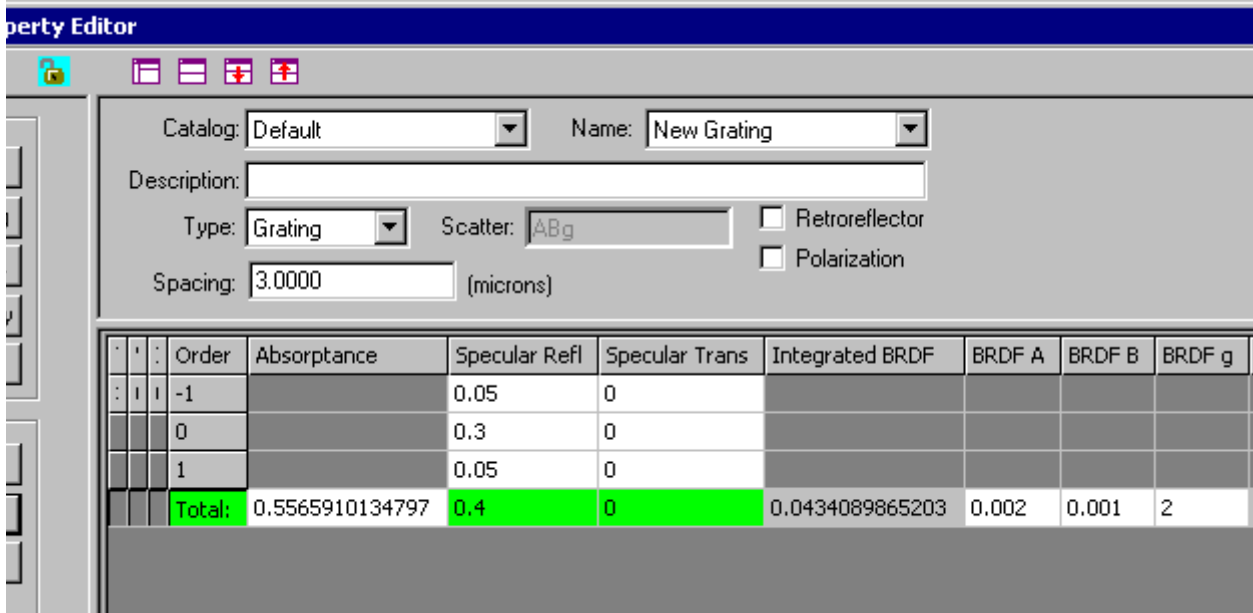

FIGURE 9.49 - A completed Grating Surface Property with one angle of incidence, three grating orders and BRDF.

This surface property is a reflection grating, and we have added a BRDF as well. When you specify a BRDF, the Integrated BRDF or Total Scatter (TS) will be split up between the diffracted orders, in proportion to the efficiency.

To apply a grating surface property to a surface, select the surface and select **Define|Apply Properties**, Surface tab in the usual way. When you select the grating property from the Surface Property drop-down list, the Up Direction also appears.

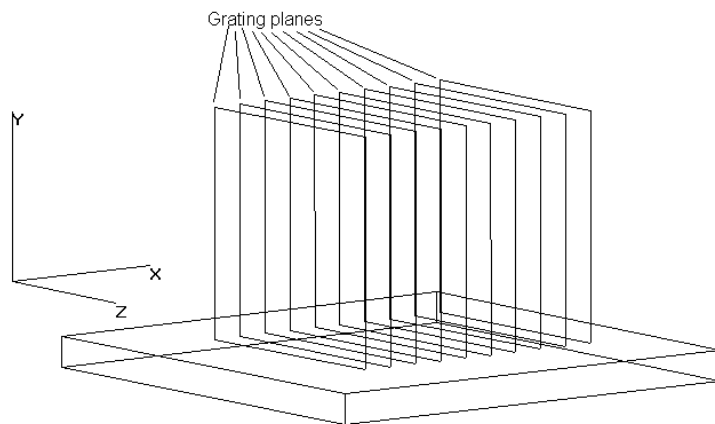

FIGURE 9.50 - Rectangular substrate with grating formation planes. In this example, the grating Up Direction could be along the +x or -x axis.

The Up Direction is a unit vector that is perpendicular to the grating planes, and points in the direction of positive diffracted orders. An example is shown in Figure 9.51.

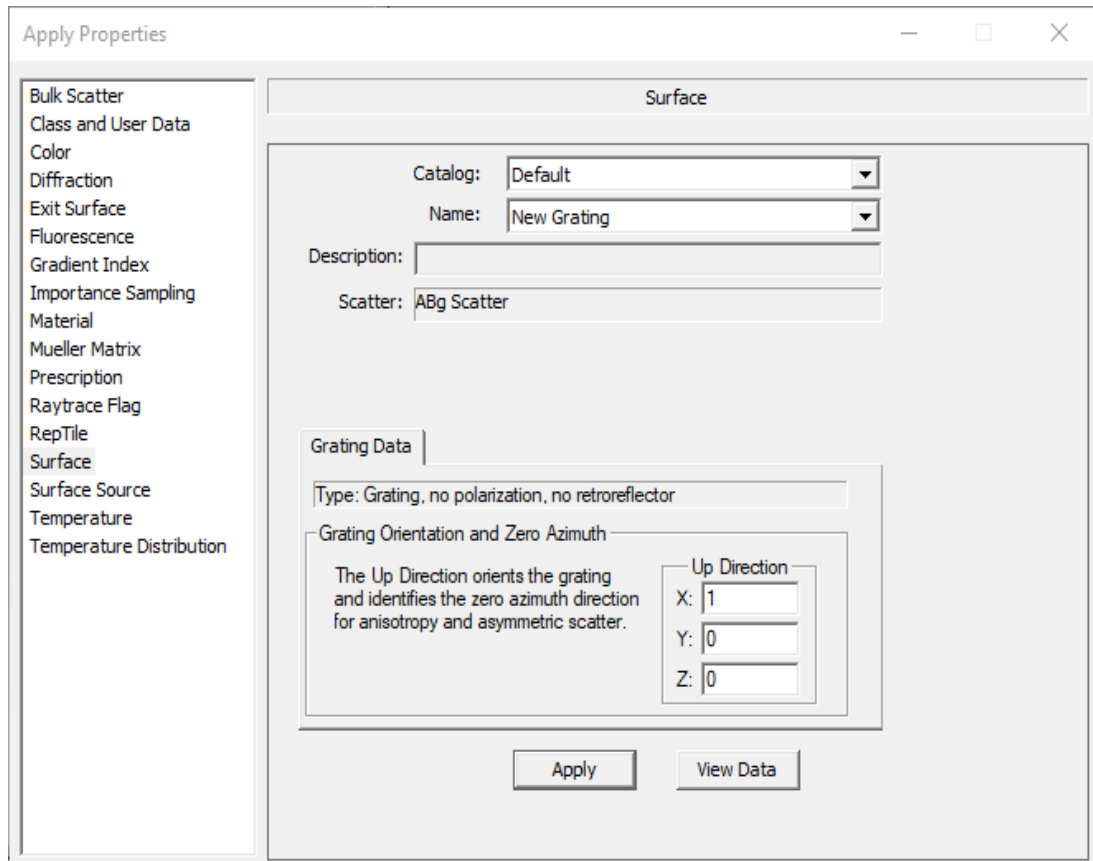

FIGURE 9.51 - Grating Surface Property applied to a plane surface. The Up Direction is along the +x axis.

Ray-tracing a Grating Surface Property

When a ray intersects a surface with a Grating Surface Property applied, TracePro will interpolate the efficiency data for the given angle of incidence. If the direction of incidence is such that one or more orders cannot exist, the flux from those orders will be given to the remaining orders, in proportion to their efficiencies. In our example, the grating has reflected orders only, and a BRDF is defined. In Figure 9.52, the diffracted orders are shown in different views. The scattered rays have flux below the default flux threshold of 0.05, so they are not traced.

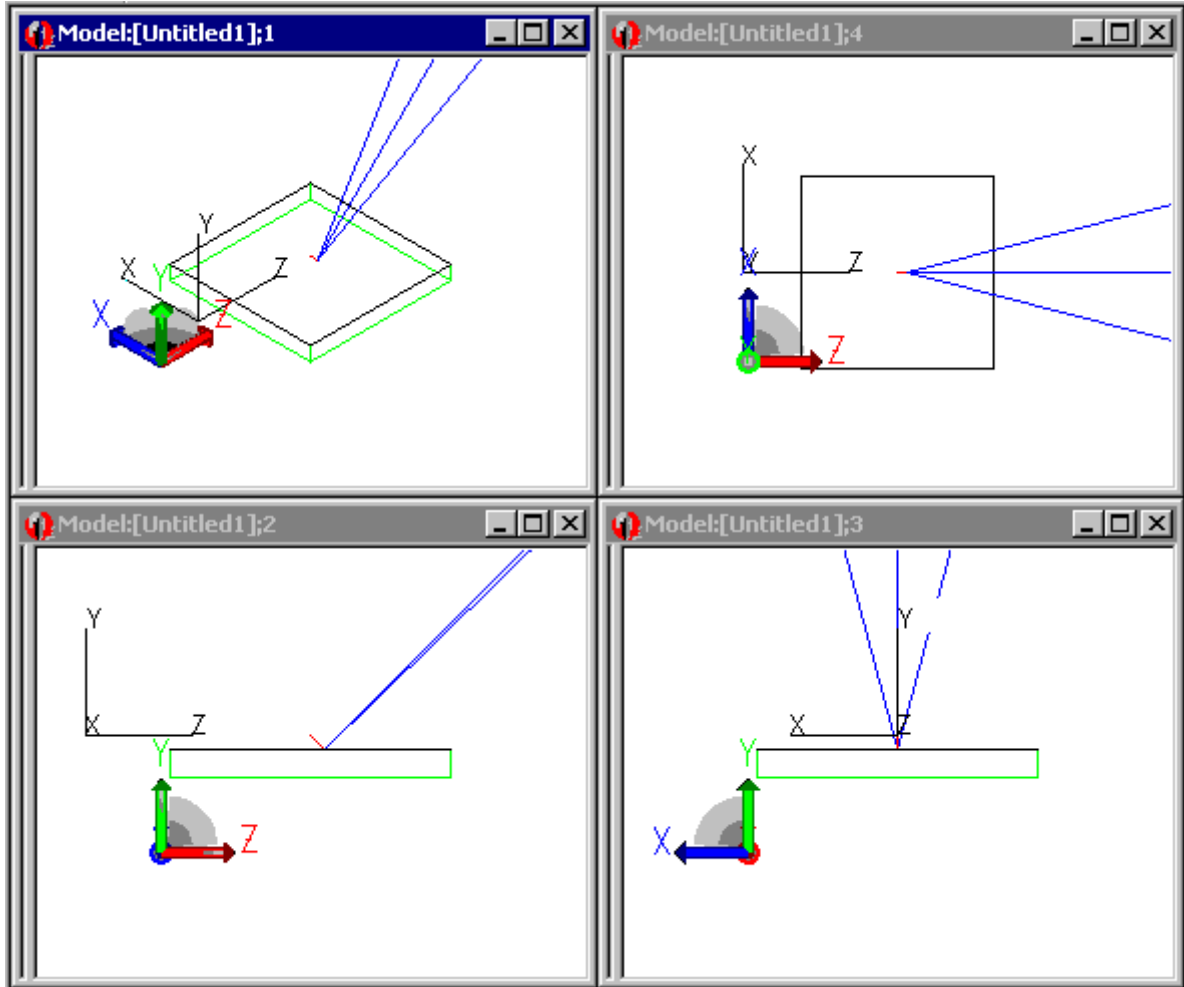

FIGURE 9.52 - Diffracted orders for the example Grating Surface Property. Scattered rays have flux below the threshold so they are not traced.

If we lower the flux threshold (to 0.001 in this example) we see that the scattered rays are traced, and there is one scattered ray for each diffracted order as shown in Figure 9.53.

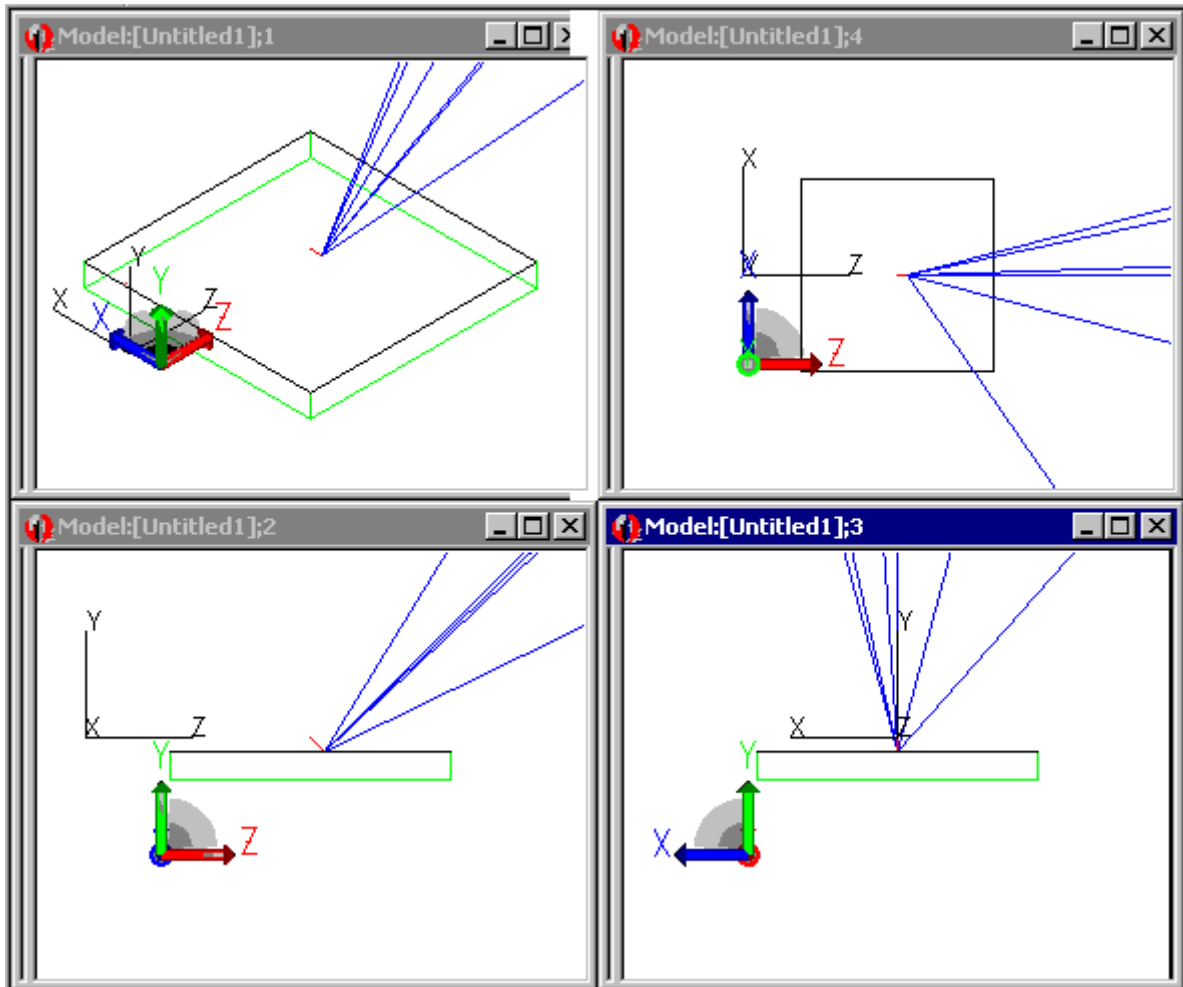

FIGURE 9.53 - The example in Diffracted orders for the example Grating Surface Property. Scattered rays have flux below the threshold so they are not traced.6 has been re-run with flux threshold lowered to 0.001 so that scattered rays are traced.

Example Using Reverse Ray Tracing

In this example we will start with the **EllipticalReflector_Reverse.oml** model and use reverse ray tracing.

First, open the **EllipticalReflector_Reverse.oml** example model. In forward ray tracing, you would begin a surface source ray trace. Rays would be emitted from the **Arc:Cyl** surface, and rays would be collected at the **Observation disk:Front** surface (see Figure 9.54). Once the ray trace is completed, you would select the **Observation disk:Front** surface and display an Irradiance/Illuminance map using **Analysis | Irradiance/Illuminance Maps**. You could also display a Candela plot using **Analysis | Candela plots**, sort the rays using **Analysis | Ray Sorting**, display an incident ray table using **Analysis | Incident Ray Table**, or display ray histories using **Analysis | Ray Histories**.

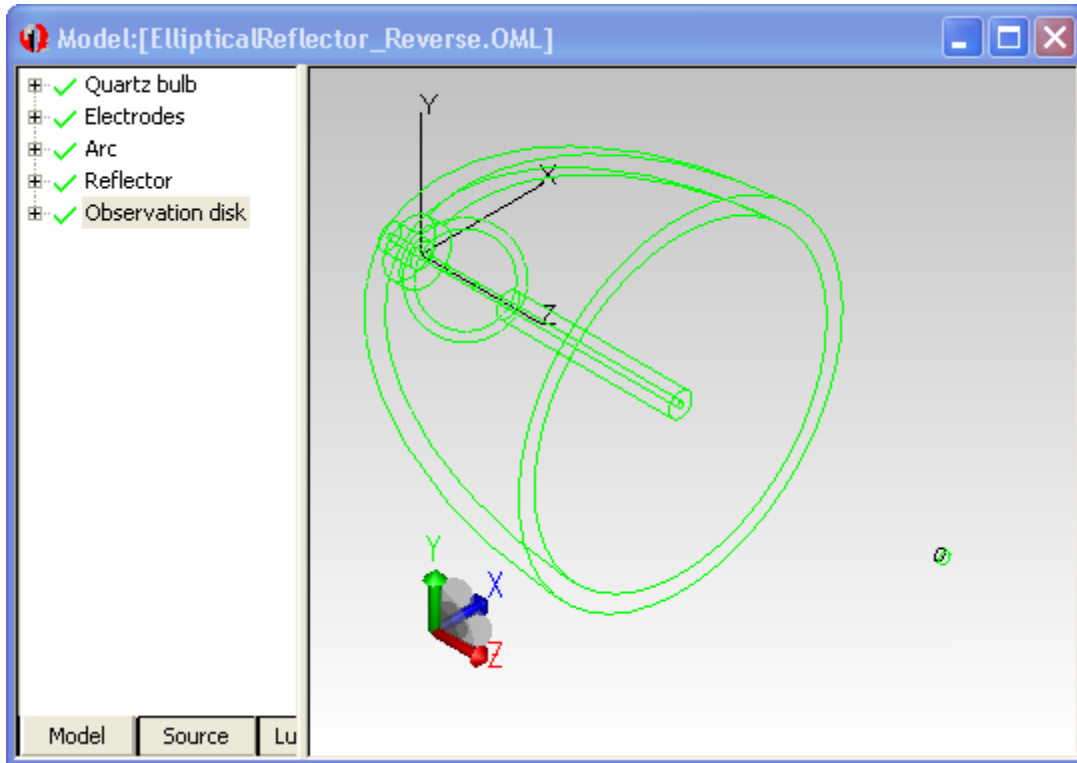

FIGURE 9.54 - EllipticalReflector_Reverse.oml example model from www.lambdare.com Technical Support TracePro Examples. In a forward ray trace, rays are emitted from the Arc:Cyl surface source and flux collected at the Observation disk:Front surface. In a reverse ray trace, rays are emitted from the Observation Disk:Front surface and collected at the source.

In a reverse ray trace you can display all of these analysis results, but in some cases they have a different meaning. By way of going through this example, we will see how the meaning is different.

We will do a reverse ray trace in which rays are emitted from the **Observation disk:Front** surface. You can choose whatever surface you would like from which to start the reverse rays. The only requirement is that you first make the surface an exit surface.

Specifying reverse rays

Using the EllipticalReflector_Reverse.oml model, select the **Observation disk:Front** surface and then select **Define|Apply Properties** to open the **Apply Properties** dialog box. Select the **Exit Surface** tab, check the **Exit surface** checkbox, and enter 1000 for the *Number of reverse rays*, as shown in Figure 9.55. Click **Apply** to apply the setting to the surface.

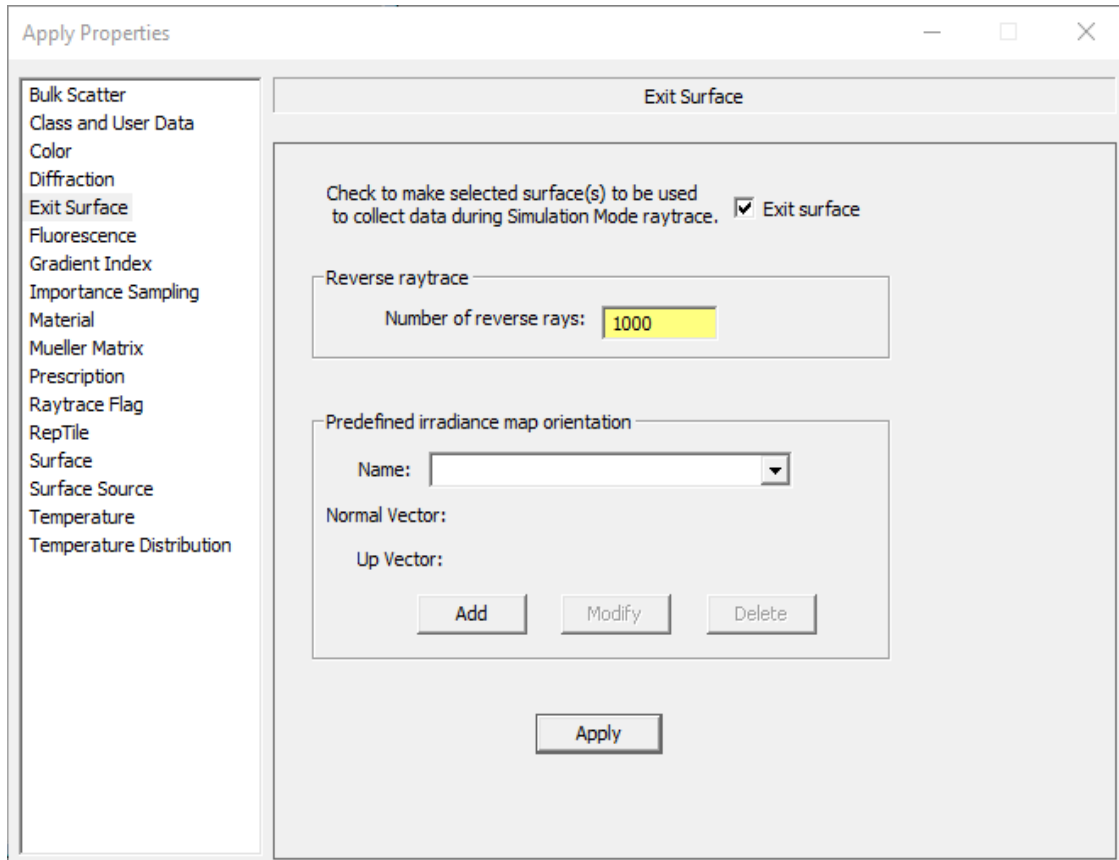

FIGURE 9.55 - Apply Properties dialog box showing the exit surface defined. 1000 reverse rays have been applied to the exit surface.

Setting importance-sampling targets

In order to make reverse ray tracing work, you must define importance-sampling targets for creating the reverse rays. The rays will be assigned an étendue value equal as described in the section “Theory of reverse ray tracing” on page 5.37, with solid angle determined by the importance-sampling target. Without one or more targets, the étendue cannot be calculated in a meaningful way. The target(s) are assigned to each exit surface from which reverse rays will be traced. In this example, we will use one importance sampling target and apply it to the **Observation disk:Front** surface. Select this surface and open the **Apply Properties** dialog box as in the previous section, but now select the **Importance Sampling** tab. We will create an annular importance sampling target at the front of the reflector, which is located at $z = 500$, with outer radius = 280 and inner radius = 20. We will also create cells on the importance-sampling target by dividing it into radial and azimuthal segments in a 4x4 pattern. Fill in the values shown in Figure 9.56 and click *Apply* to create the target. With these segments, for every reverse ray specified, $4 \times 4 = 16$ rays will be generated. Because we specified 1000 reverse rays, 16,000 actual rays will be generated.

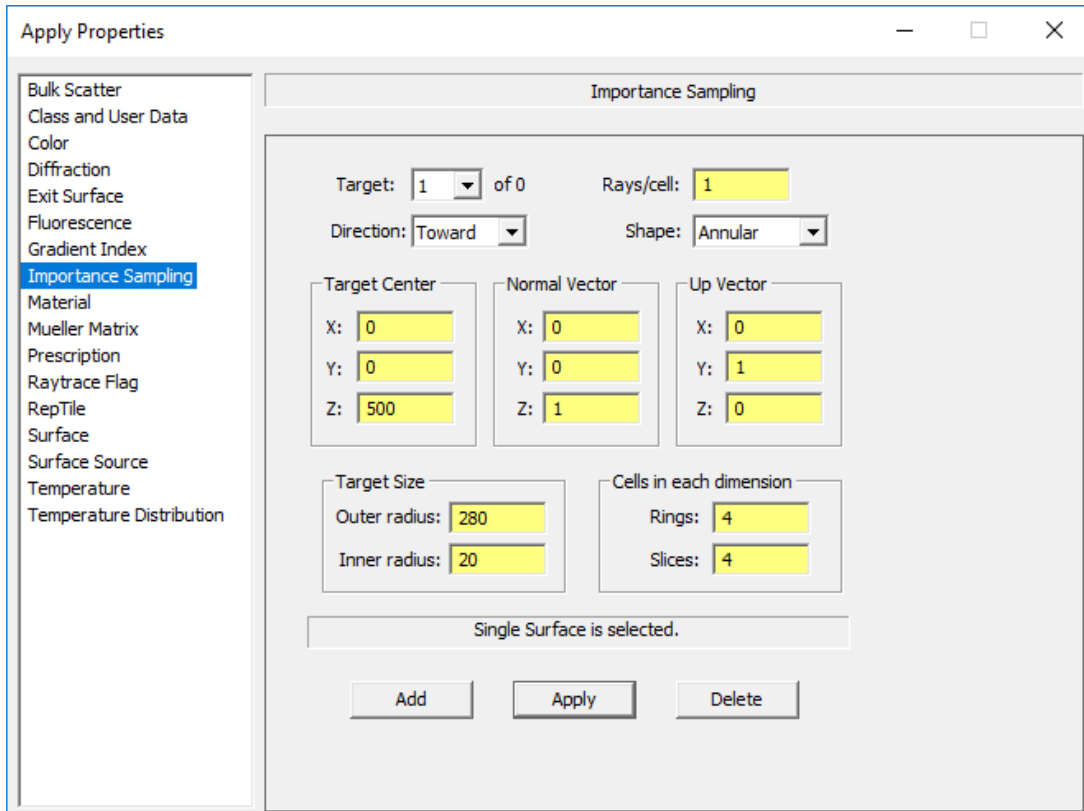

FIGURE 9.56 - Applying an importance sampling target to the Exit Surface.

Tracing Reverse Rays

Now we are ready to trace reverse rays. Select **Raytrace|Reverse Raytrace** to begin the ray trace. Alternatively, you can click the *Reverse Trace* button on the toolbar.

Once you start the ray-trace, the Audit progress dialog box will appear, followed by the Raytrace Progress dialog box, the same as for a forward ray trace. After the ray trace finishes, you are ready to view analysis results. Figure 9.57 shows the model window after the ray trace has finished, with rays displayed.

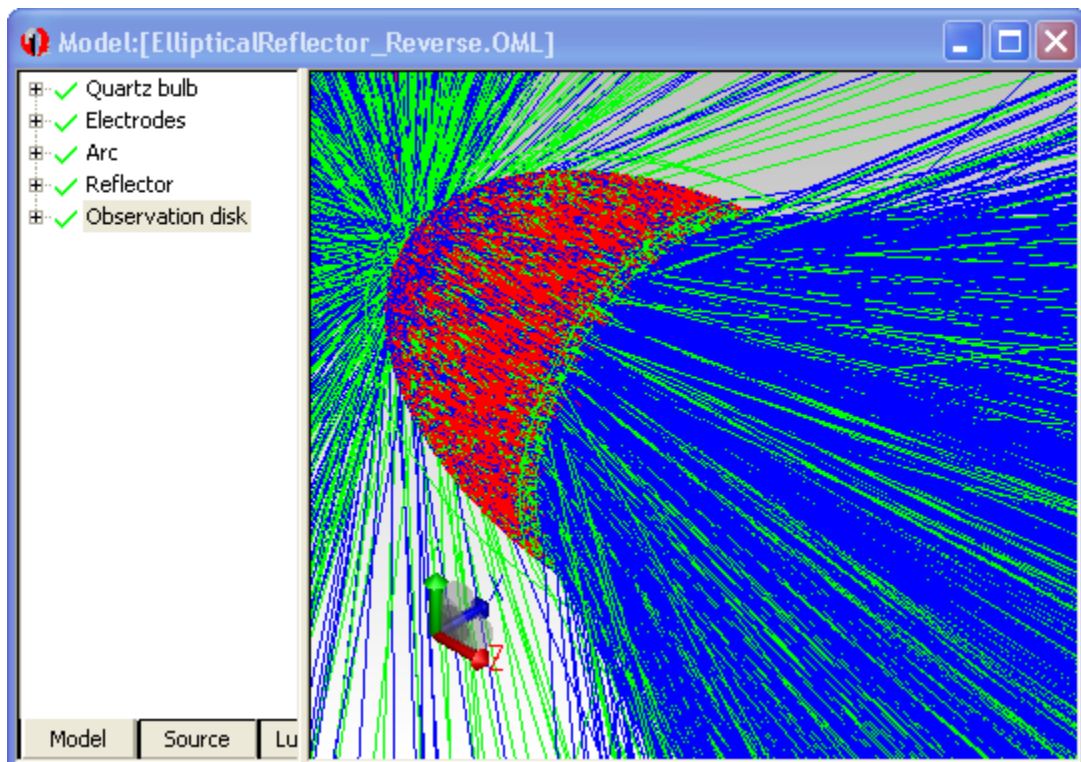

FIGURE 9.57 - Completed Reverse Ray-trace with rays displayed.

Viewing Analysis Results

Analysis results can be viewed in much the same way as for a forward ray trace, but sometimes the meaning is different. The differences and similarities are described in the sections below.

Irradiance/Illuminance Map

To display an irradiance/illuminance map at an exit surface, first select the exit surface and then select **Analysis | Irradiance/Illuminance Maps**, the same as you would for a forward ray trace. The incident illuminance on the exit surface will be displayed, *the same as if the rays were traced forward*. The Irradiance/Illuminance map for our example is shown in Figure 9.58. Note that about 29,000 rays reached the observation disk. If you do a forward ray trace with 100,000 rays (this will take much longer than the reverse ray trace), only about 4,000 rays will reach the observation disk, resulting in a much noisier illuminance map.

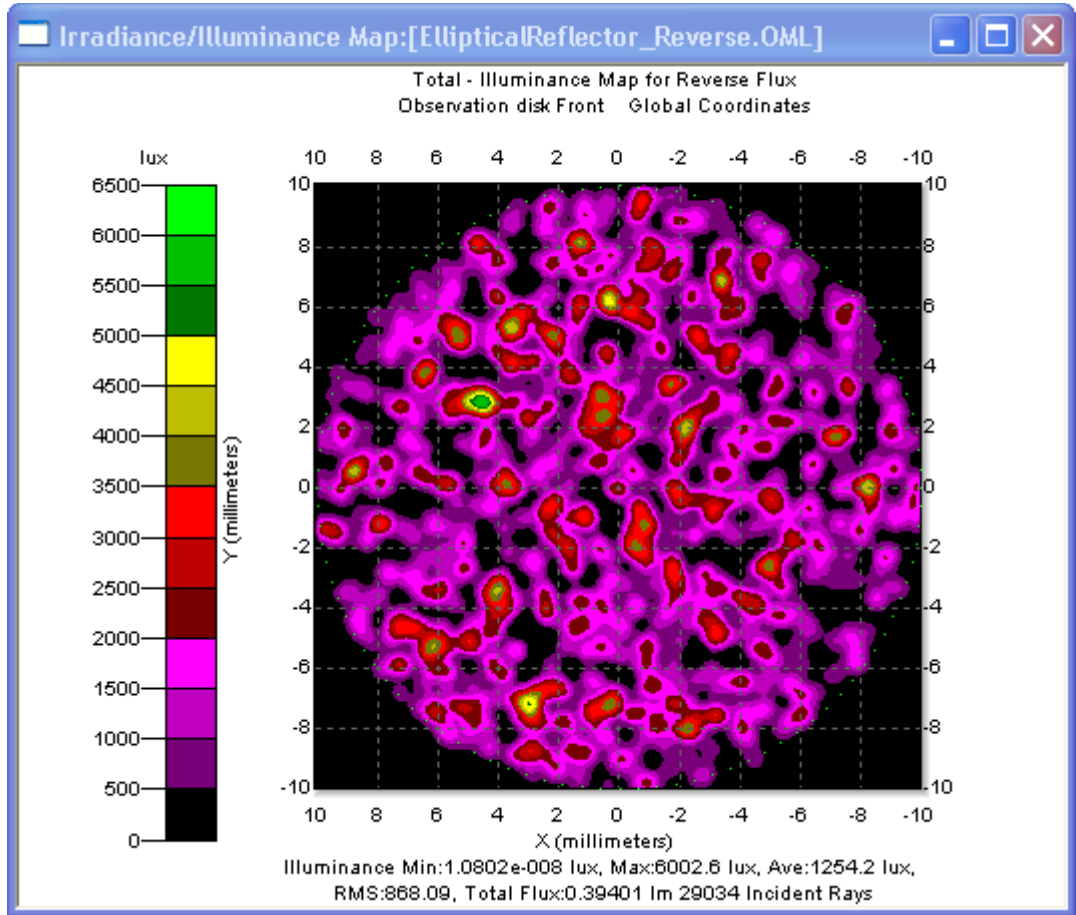

FIGURE 9.58 - Illuminance map for reverse ray trace.

Ray Sorting



To show only the rays that produce irradiance/illuminance at the observation surface, select the **Observation disk:Front** surface and select **Analysis | Ray Sorting**. From the drop-down list, select *Selected Surface* as shown in Figure 9.59 and click *Update*. The only rays displayed are those that would have come from the source and struck the exit surface in a forward ray trace. The sorted rays are shown in Figure 9.60.

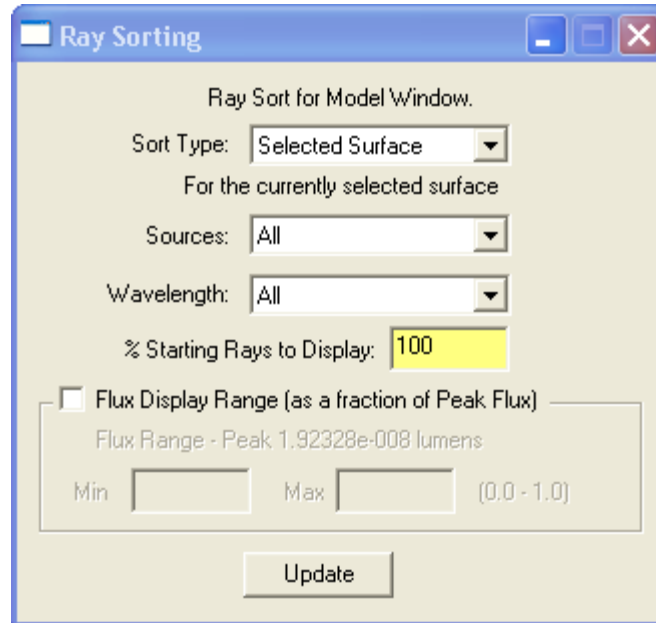

FIGURE 9.59 - Ray sorting dialog box with Sort Type set to Selected Surface.

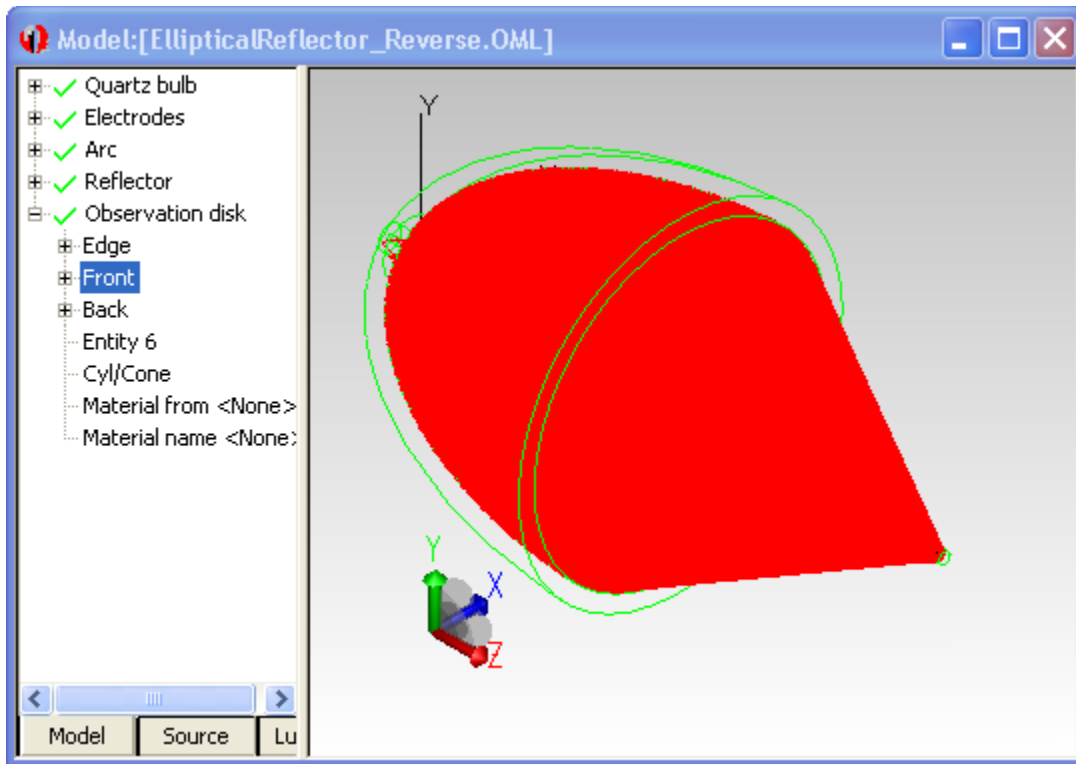

FIGURE 9.60 - Sorted ray display with settings as shown in Figure 9.59.

Candela Plot

The only options available for Candela plots are for rays incident on or exiting a surface, which you control via the **Analysis|Candela Options** dialog box. This is because in a reverse ray trace, rays always start from a surface, not from an infinite distance, as they would have to for a “missed rays” Candela plot. To view a polar iso-candela plot for rays incident on the **Observation disk:Front** surface, simply select the surface, then select **Analysis|Candela Plots|Polar Iso-Candela**. The plot should appear as in Figure 9.61.

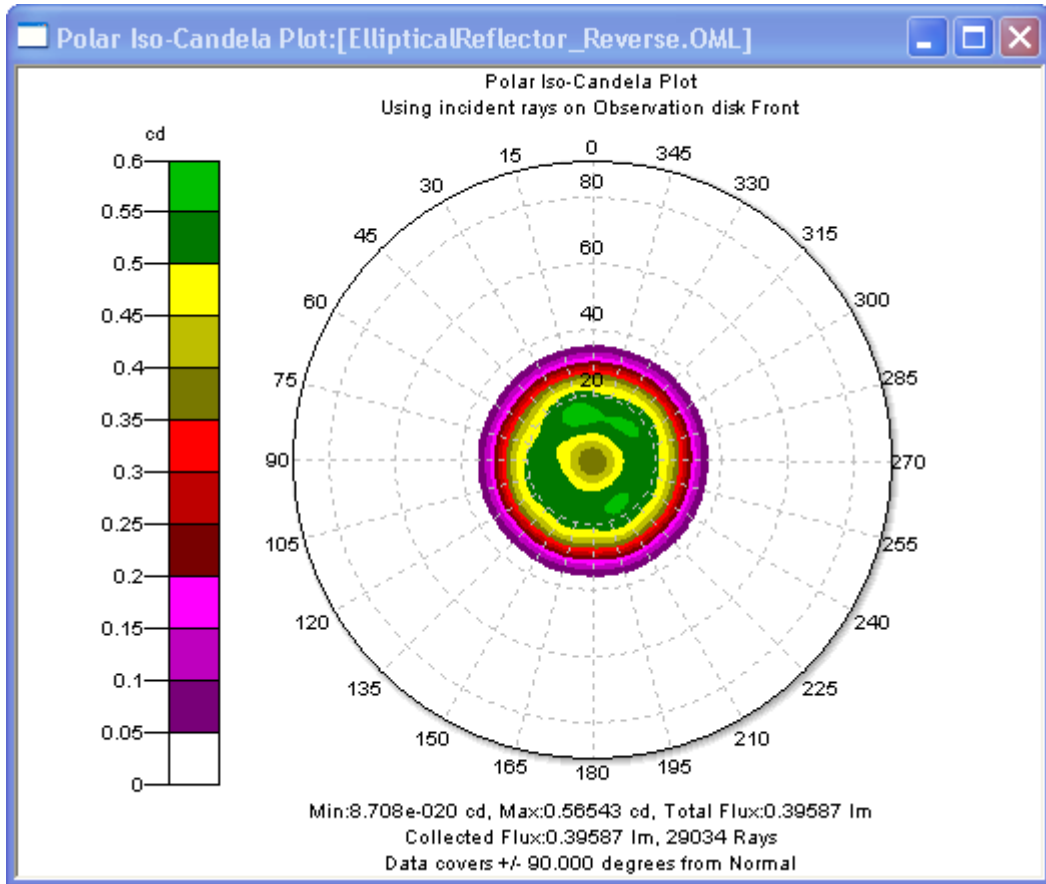

FIGURE 9.61 - Polar iso-candela plot for the Observation disk:Front surface.

If the plot is blank or does not appear as in Figure 9.61, open the **Analysis|Candela Options** dialog box and check that the settings are as shown in Figure 9.62.

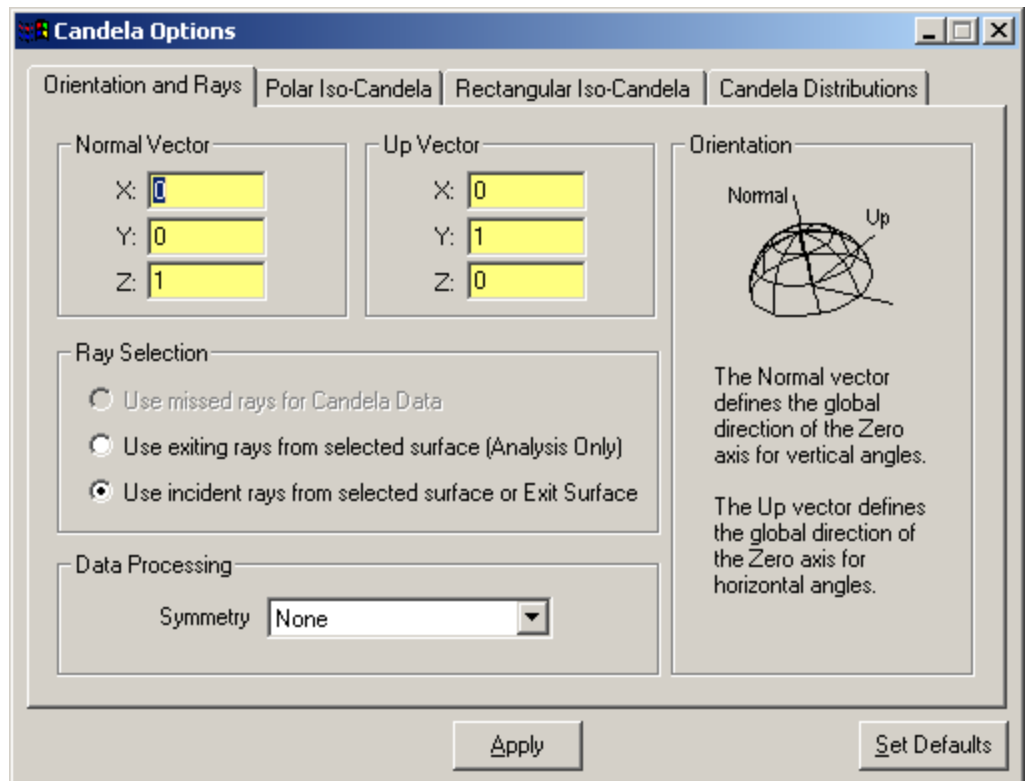

FIGURE 9.62 - Candela plot options to produce the plot in Figure 9.61. Note that the option *Use missed rays for Candela Data* is not available for a reverse ray trace.

If you select *Use exiting rays from selected surface (Analysis Only)* in the Candela Options dialog box and click Apply, the resulting plot will be blank. This is because the rays were started in reverse from the selected surface, so there are no rays exiting the surface in the forward direction.

The other candela plots are also available for a reverse ray trace. Refer to the TracePro User's Manual for their use.

Incident Ray Table

The Incident Ray Table does not consider the sense of the rays, that is, it reports rays incident on the surface in the reverse direction. For example, select the **Reflector:Inside** surface and then select **Anal ysi s | I nci dent Ray Tabl e**. The table will be displayed as shown in Figure 9.63.

Ray Number	Wavelength	Start Ray	Ray Node	Type	History	Flux	X Pos.	Y Pos.	Z Pos.	X Vec.	Y Vec.	Z Vec.
1	0.5461	1	2		Emitted	4.45596e-006	-47.0439	124.585	63.5994	-0.184253	0.258952	-0.948153
2	0.5461	1	7	SpecTran		3.48172e-006	41.1026	-204.265	174.818	0.237118	-0.916288	0.322787
3	0.5461	2	2		Emitted	3.11351e-006	-122.539	208.231	259.251	-0.301301	0.397174	-0.866874
4	0.5461	2	7	SpecTran		2.19656e-006	53.3789	-162.331	109.693	0.383656	-0.903134	-0.192762
5	0.5461	2	8	SpecTran		1.88524e-007	41.0531	-65.4181	20.5214	0.296066	-0.129031	-0.946412
6	0.5461	3	2		Emitted	3.53346e-006	-216.454	51.5055	206.602	-0.396258	0.205992	-0.894733
7	0.5461	3	7	SpecTran		2.68699e-006	158.391	18.4435	94.0012	0.97672	-0.0389181	-0.210956
8	0.5461	4	3	SpecRefl		3.20043e-007	-195.14	-30.3904	153.434	-0.994489	-0.102904	0.0200784
9	0.5461	4	6	SpecTran		2.93776e-006	-108.893	-4.07051	41.6841	-0.572516	0.0717379	-0.816749
10	0.5461	4	7	SpecTran		4.88121e-007	-55.9804	6.11751	10.8111	0.126782	0.167319	-0.977717
11	0.5461	4	12	SpecTran		3.81211e-007	230.467	51.2741	242.657	0.776795	0.128814	0.616439
12	0.5461	4	5	SpecTran		7.02031e-007	-170.495	-21.2158	111.043	-0.971779	-0.061438	-0.227752
13	0.5461	5	2		Emitted	3.37689e-006	73.2752	239.119	287.779	-0.0765751	0.459921	-0.884652
14	0.5461	5	4	SpecRefl		2.98835e-007	-201.123	20.4542	162.332	-0.978139	-0.159128	0.133873
15	0.5461	5	6	SpecTran		2.63378e-006	-179.215	-14.5989	123.163	-0.927728	-0.365792	-0.0742822
16	0.5461	5	8	SpecTran		2.45684e-007	-153.759	-39.0203	92.9251	-0.795138	-0.540053	-0.275857
17	0.5461	6	2		Emitted	2.44052e-006	-45.0093	267.009	383.954	-0.23824	0.527187	-0.815669
18	0.5461	6	3	SpecRefl		2.31527e-006	-52.5881	-136.955	78.3163	-0.0149597	-0.797378	-0.603294
19	0.5461	6	4	SpecRefl		2.19644e-006	221.368	166.651	431.606	0.506942	0.561807	0.653744
20	0.5461	7	2		Emitted	2.86506e-006	-258.347	-65.5408	359.271	-0.52113	0.0869484	-0.849037
21	0.5461	7	3	SpecRefl		2.71801e-006	64.1318	120.012	66.5971	0.681239	0.39198	-0.618276

FIGURE 9.63 - Example Incident Ray Table for the Reflector:Inside surface.

Ray History Table

The Ray History Table does not consider the sense of the rays, that is, it reports rays incident on the surface in the reverse direction. For example, select the **Reflector:Inside** surface and then select **Anal ysi s | Ray Hi stori es**. The table will be displayed as shown in Figure 9.64, with the history starting from the exit surface and proceeding to the reflector.

Wavelength	Ray Node	Start Ray	X Pos.	Y Pos.	Z Pos.	Flux	OPL	X Vec.	Y Vec.	Z Vec.	Type	History	Object	Surface
0.5461	1	1	134.925	-131.157	1000	4.45596e-006	0	-0.184253	0.258952	-0.948153		Emitted	Observation disk	Front
0.5461	2	1	-47.0439	124.585	63.5994	4.45596e-006	987.604	0	0	0		At Surface	Reflector	Inside

FIGURE 9.64 - Example Ray History Table for the Reflector:Inside surface.

Example using multiple exit surfaces

In this example we will start with the EllipticalReflector.oml model and modify it so that it has multiple exit surfaces. This example will show the true power of reverse ray tracing. We will first make one small exit surface, apply all needed properties to it, then perform a **Move/Copy** to make several exit surfaces. It is important to apply the properties before doing **Move/Copy** to avoid having to re-apply the properties to each new object.

First, open the EllipticalReflector.oml model. Then delete the **Observation disk** object. To do this:

1. Select **Edit | Select | Object** (or click the *Select Object* toolbar button) to turn on the object selection tool.
2. Select the Observation disk object as shown in Figure 9.65.
3. Press the Delete key on your keyboard (or select **Edit | Cut** or type <Ctrl-X>). The object is now deleted.

Select **File | SaveAs** and save the model with a new name, e.g. eliprefl_multiexit.oml.

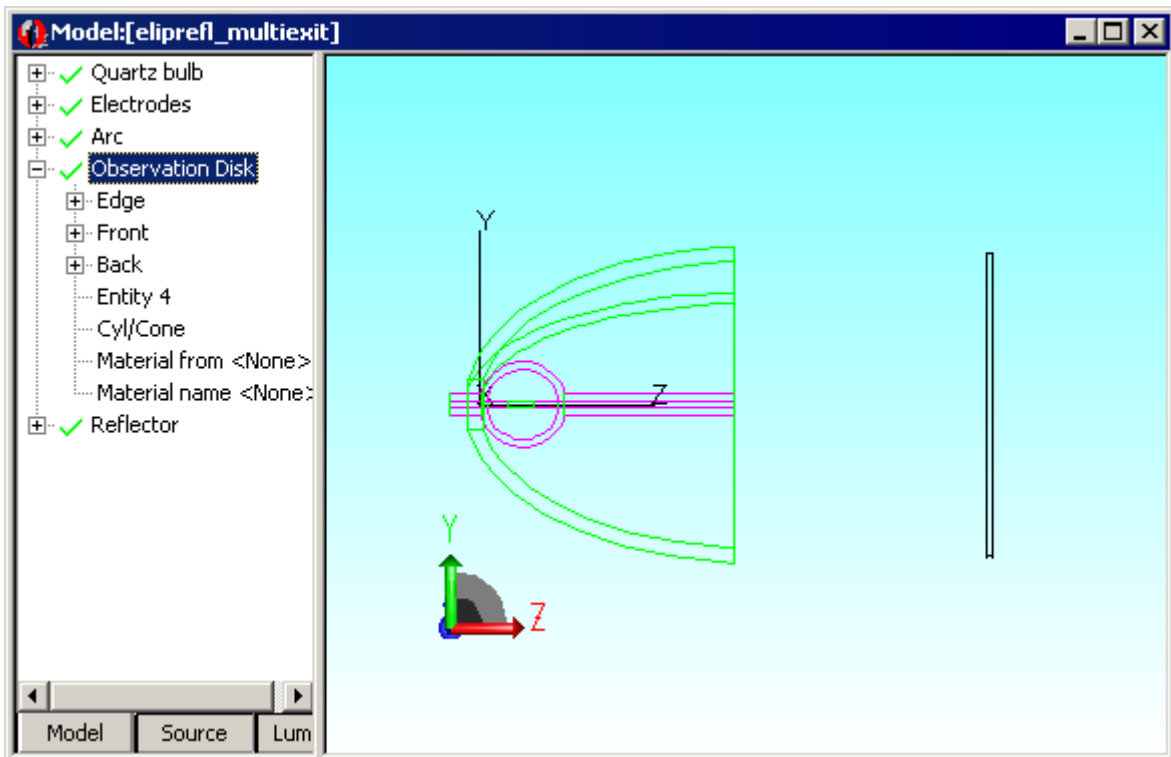

FIGURE 9.65 - eliprefl.oml file with the Observation disk selected, ready for deleting.

Now we will make a new smaller exit surface. Select **Geometry | Primitive Solid** to open the *Insert Primitive Solids* dialog box and click the **Cylinder/Cone** tab. Enter the data for a cylinder with radius 10, length 10, located at $z = 1000$ as shown in Figure 9.66, and click the Insert button to create it.

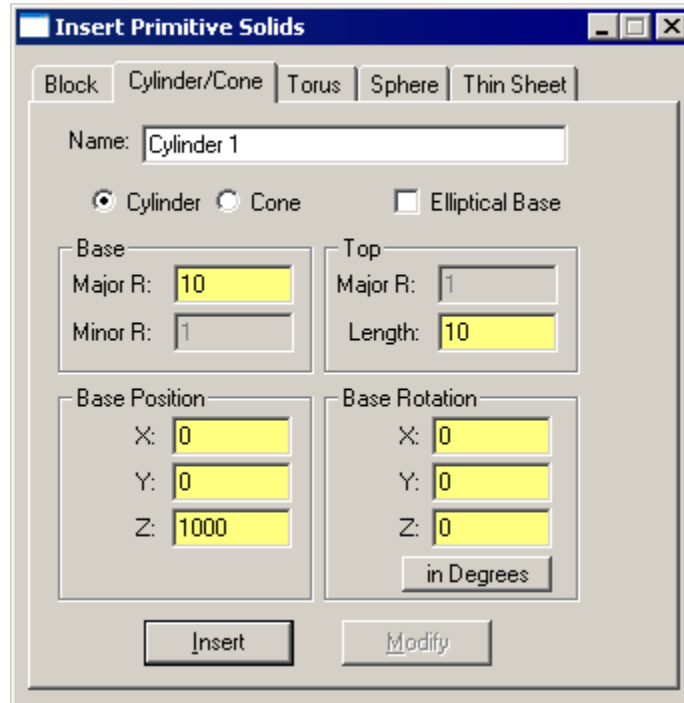

FIGURE 9.66 - Insert Cylinder/Cone with data for smaller exit surface.

Now apply all needed properties to the new cylinder object. These consist of:

1. Naming the object using the system tree. Name it Exit Surface 1.
2. Labeling each of the three surfaces (Edge, Front and Back) in the same way as the Observation disk surfaces were labeled.
3. Selecting the Front surface and making it an Exit Surface as in Figure 9.68.
4. Setting the number of Reverse Rays on the Front surface as in Figure 9.55 on page 9.53.
5. Defining an importance sampling target on the Front surface as in Figure 9.56 on page 9.54, except set the number of rings to 1 and the number of slices to 1.

To make an array of exit surfaces, first select the new object and then select **Edit | Object | Move** to open the *Move* dialog box. Enter 40 for the y component of the Move as shown in Figure 21. Now click the Copy button. This will copy the object, then move it by 40 in the +y direction. The copy of the object is located at $y = 40$, and the original has been moved to $y = 0$. Click the Copy button six more times to create eight Exit Surface 1 objects.

Note: By applying all of the properties to the object named Exit Surface 1, each copy holds the properties so they will not need to be applied to the copies.

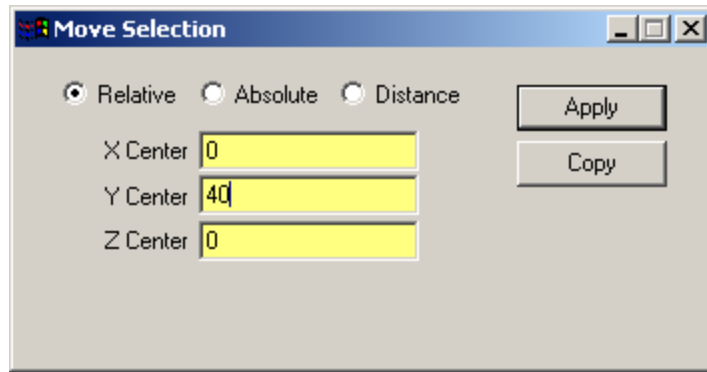

FIGURE 9.67 - Edit|Object|Move dialog box ready for moving the object by 40 in the y direction.

Open the System Tree and rename the objects so that they are named Exit Surface 1 through Exit Surface 8. Label the one at $y = 0$ as Exit Surface 1, the one at $y = 40$ as Exit Surface 2, etc. The completed model is shown in Figure 9.68. Select **F I I e | Save** to save the model.

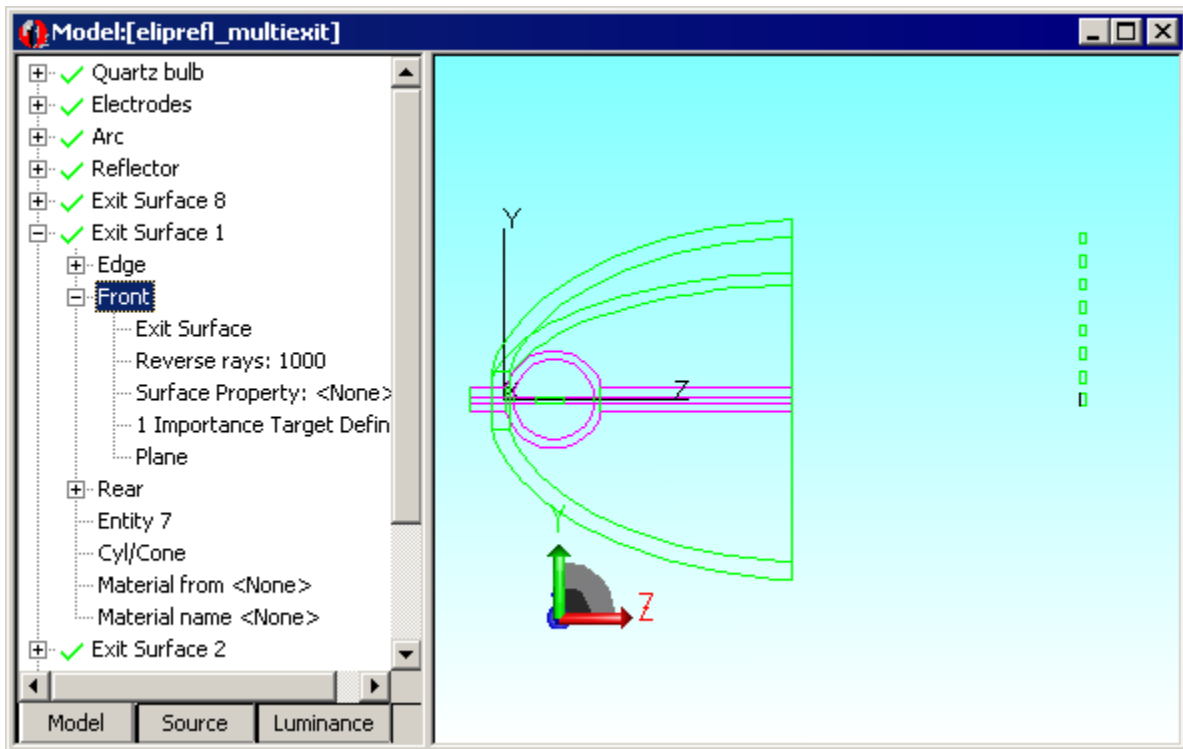

FIGURE 9.68 - Completed model with multiple exit surfaces.

Now the model is ready for tracing reverse rays. Select **Raytrace | Reverse Raytrace** to begin the ray trace, or simply click the Reverse Trace button on the toolbar. Once the ray trace is completed, you can select any of the exit surfaces to see an Irradiance/Illuminance Map, Candela Plot, or any other analysis results as discussed above. The ray sorting is especially useful for a model like this, as it

allows you to see what paths are taken for each part of the illuminated spot. For example, select the **Exit Surface 4:Front** surface, then select **Analysis|Ray Sorting**. For the *Sort Type*, select *Selected Surface* as shown in Figure 9.59 on page 9.57, then click Update. The ray display should appear as in Figure 9.69. You can select each of the exit surfaces in turn and update the ray sorting to see the paths of rays that hit that surface.

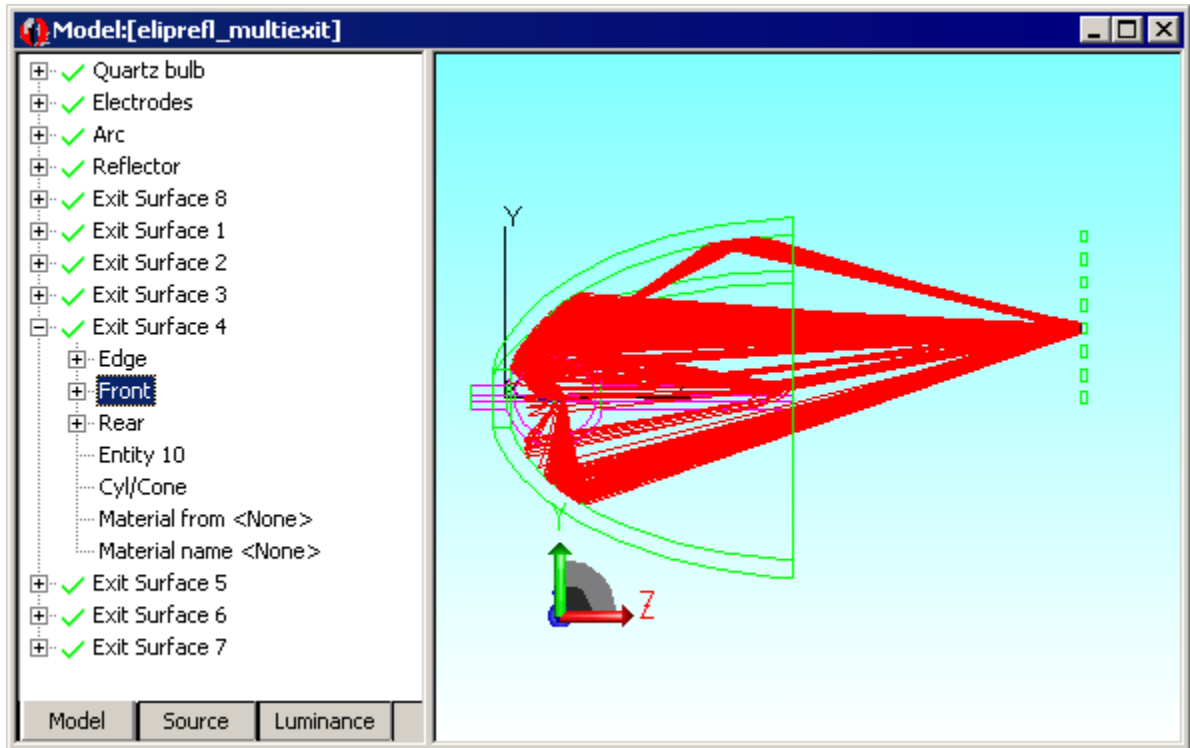

FIGURE 9.69 - Paths of rays that hit Exit Surface 4:Front.

Example Using Luminance/Radiance Maps

Expanding upon the example presented earlier, “Luminance/Radiance Maps” on page 6.18, it is used here to illustrate the utility of auto importance sampling toward sources. The OML file can be found by signing in to the Lambda Research web site and navigating to the TechnicalSupport/TracePro/Examples section. Find the file:

glass sphere on red-white checkerboard.oml

The tutorial that describes how to use the Radiance/Luminance Map function is found in the TechnicalSupport/TracePro/Tutorials section:

LuminanceMapExample.pdf

Note that the glass sphere on red-white checkerboard.oml is an exercise left to the user within the tutorial. This more complex analysis is used in this section to illustrate the utility to display True Color. Follow the tutorial on how to setup TracePro for replicating the results displayed here. This example displays a Luminance Map, but one could do a similar ray trace with a Radiance Map - i.e., the two terms can be used interchangeably for the purposes of presentation in this

manual. The only difference between the two is that a Radiance Map is displayed in radiometric units (e.g., $W/sr/m^2$) and a Luminance Map is displayed in photometric units (e.g., $cd/m^2 = nit$).

Two ray traces have been performed with the selected options as shown in Figure 5.28 on page 5.40, with the latter having the Auto importance sampling box checked:

- Figure 8: displays the results without auto importance sampling and
- Figure 9: displays the results with auto importance sampling.

In both cases the Color scheme (**Analysis|Luminance/Radiance Map Options...**) is set to True Color and False Color Gradient Rainbow.

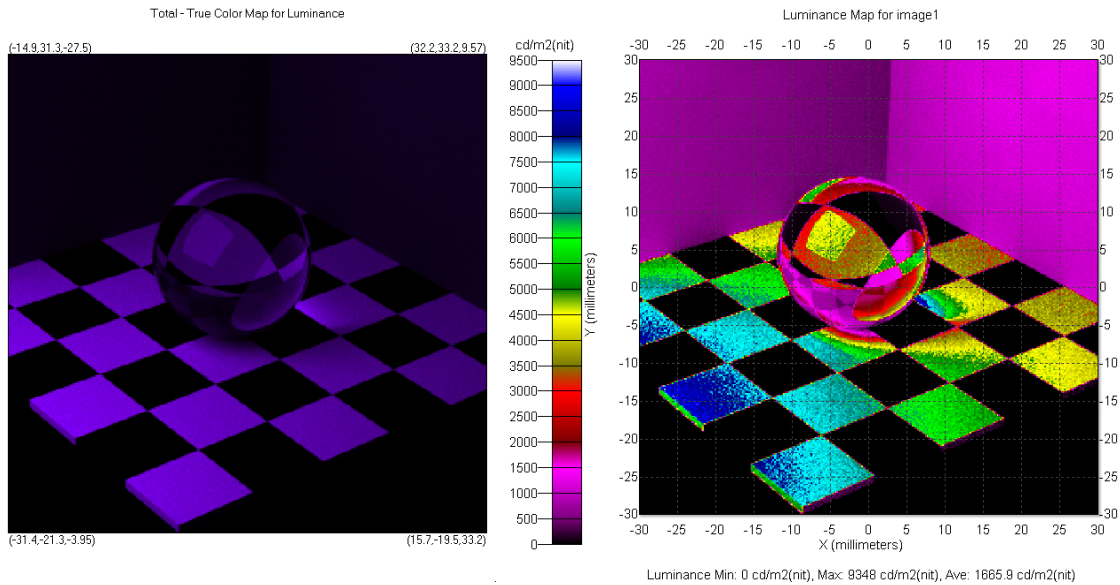

FIGURE 9.70 - Display map results without auto importance sampling in True Color and False Color Gradient Rainbow.

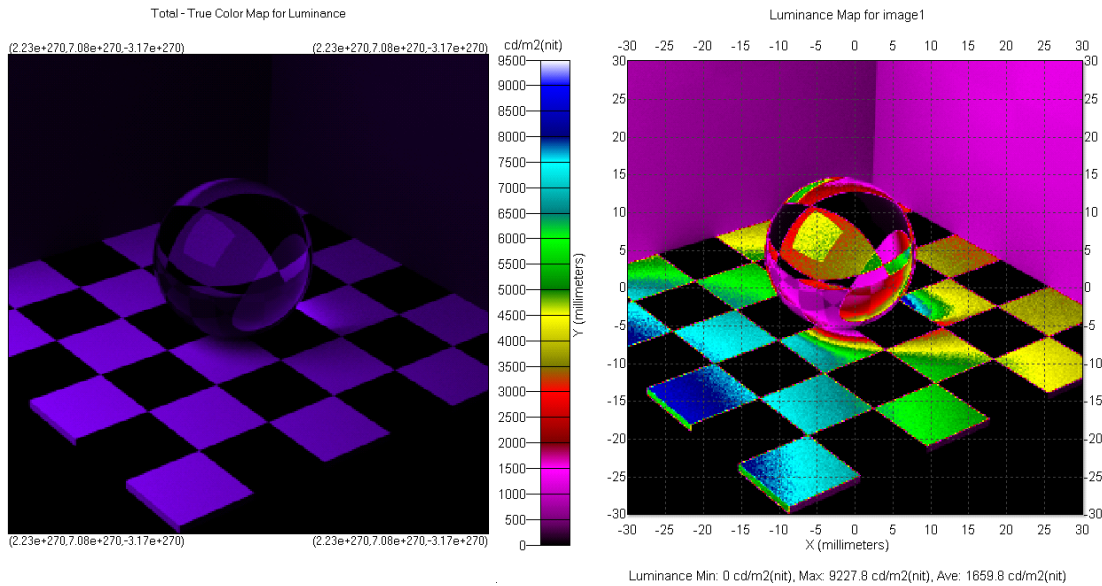

FIGURE 9.71 - Display map results with auto importance sampling.

Example Using Photorealistic Rendering

This example uses the same TracePro model as the previous example, i.e.

`glass sphere on red-white checkerboard.oml`

which you can download from the TechSupport/TracePro/Examples section of www.lambdare.com. To create a photorealistic rendering of this model, follow these steps:

1. Download the file and its associated properties file, and import the properties using **Tools|Database > Import**.
2. Open the file and manipulate the view to one similar to that shown in Figure 9.71. Hint: make the window small for a faster rendering, as the render time is proportional to the number of pixels in the window. Additional hint: Once you have the view the way you want it, save the view using **View|Named Views**, and then save the model. This will make it easier to repeat the rendering in a future TracePro session by recalling the named view.
3. Select **Raytrace|Raytrace Options > Advanced** and set **Select Mix of Audit speed vs. Raytrace speed** to **Fastest Raytrace**.
4. Select **View|Photorealistic Rendering > Setup** and observe the default settings for rendering, especially the **Rendering Quality** setting of **High**.
5. Select **View|Photorealistic Rendering > Render** to begin the rendering process. A blank graphics window will open, and the **Raytrace Progress** dialog box will appear as TracePro builds the photon map.
6. Next the Rendering Progress dialog box will appear, and the rendering window will be updated after each rendering pass. Figure 9.72 shows the appearance of the rendering window after one pass.
7. The completed rendering is shown in Figure 9.73. The scene appears bright and washed out due to the characteristics of this particular model and how

TracePro normalizes the luminance. To improve the appearance, select **Photorealistic Rendering Options** and change the **Brightness** and **Contrast** settings to your liking. An example with Brightness set down to 15 and the Contrast left at the default value of 50 is shown in Figure 9.74.

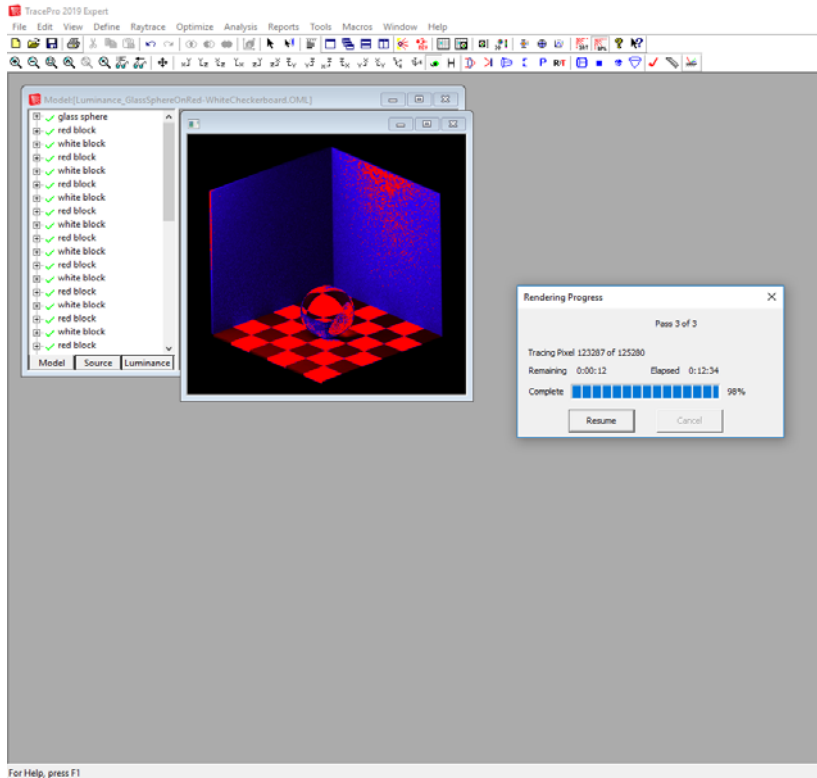

FIGURE 9.72 - Photorealistic rendering result after two rendering passes.

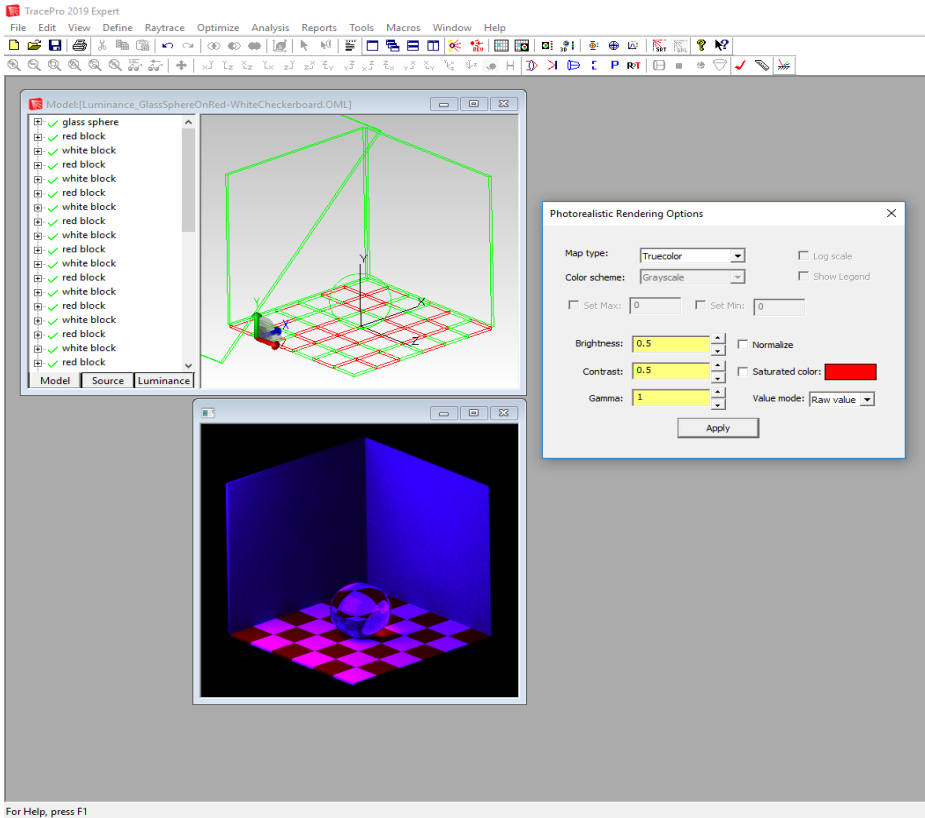

FIGURE 9.73 - Photorealistic rendering result after three rendering passes (Quality set to High) with Brightness and Contrast at default values of 0.5.

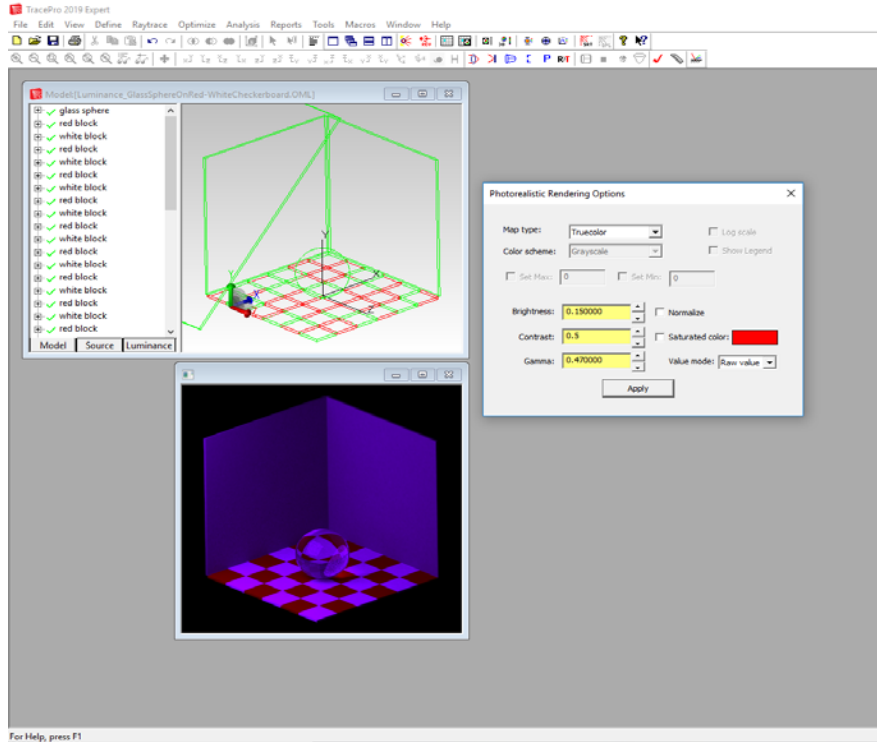

FIGURE 9.74 - Photorealistic rendering result with Brightness adjusted to 0.15.

Index

Numerics

- 1D ABg BSDF 7-24
- 1D Table BSDF 7-25
- 2D Interactive Optimizer 5-58
- 3D compound
 - reflector 2-27
- 3D Interactive Optimizer 5-58

A

- ABg coefficients 7-17
- absorptance
 - and emissivity 4-18
- absorption
 - bulk scattering 7-62
 - surface property 7-15
 - units 3-5
- absorption coefficient 3-5, 3-8, 7-14
 - bulk scattering 7-62, 7-63
 - material property 7-7
 - stack 3-44
- Advanced Selection 1-12
- All rays one color 6-3
- Ambient Luminance 2-66
- analysis mode
 - and simulation mode 5-55
 - defined 5-54
 - ray display 6-1
 - saving ray data 5-55
 - selecting 5-54
- analysis options
 - raytrace 5-42
- Anamorphic 2-18
- Angle convention
 - candela option 6-33
- angles measured in substrate 7-48
- angular emissivity
 - surface source 4-17
- angular width
 - candela option 6-31
- anisotropic
 - defined 7-26
- anisotropy 3-10, 7-27
- aperture
 - diffraction 4-32
 - entering lens 2-19
 - lens 2-9
- arrays of objects 2-38
- Asphere RepTile 3-71
- aspheric
 - Fresnel Lens 2-24
- Asymmetric asphere 2-14
- Asymmetric cone 2-17
- Asymmetric general asphere 2-15
- Asymmetric Table BSDF 3-33, 3-39
- Asymmetric Zernike 2-17
- attenuation index 7-14
- audit 6-65

- and voxel count 5-50
- speed from voxels 2-55
- Auto levels
 - candela option 6-31
- auto-complete in Notepad++ 8-2
- automatic
 - normal and up vectors 6-44

B

- background colors 2-58
- baffle vane 2-33
 - attach to tube 2-37
 - defined 2-33
 - parameters 2-34
- Beam Setup 5-6, 5-7, 5-15
- Biconic 2-15
- biconvex lens
 - using Boolean 2-36
- Bidirectional Transmittance Distribution Function 7-16
- birefringent material 4-5
- Blackbody
 - surface source 4-12
- block
 - insert 2-3
- Boolean
 - defined 2-35
 - intersect 2-36
 - lens element 2-11
 - Solid Modeling 2-1
 - subtract 2-36
 - unite 2-37
- boolean operations 2-35
 - lens element 2-11
- BRDF
 - defined 7-16
 - surface property 3-23
- Brightness 2-67, 6-14, 6-19, 6-25
- BRRDF
 - surface property 3-24
- BSDF 3-33
 - ABg 7-17
 - and bulk scattering 7-61
 - elliptical 7-21
 - gaussian 7-24
 - Harvey-Shack 7-16
 - importance sampling 7-3
 - Importance Targets 4-24
 - Integral 7-3
 - Lambertian 7-18
 - polished surface 7-5
 - Pre-defined properties 4-1
 - shift-invariant 7-16
 - surface property 7-15
 - Surface Property Database 3-23
 - table 3-33
 - TIS 7-19
- BSDF Converter 3-41
- BSDF Properties 3-42, 3-47
- BSDF Property Editor 3-48
- BTDF
 - defined 7-16
 - surface property 3-23
- Buchdahl

GRADIUM 7-12

bulk absorption
 defined 3-8
 flux report 6-63
 material property 3-5, 4-4

bulk scattering 3-9, 4-6
 define new model 7-62
 DLL 7-63
 editing 3-9
 reference 7-61
 simulation 7-62

C

calculated wavelengths 4-17

Candela Distributions 6-34

Candela Plot 6-75

Candela Plot Viewer 6-75

candela plots 6-26
 and exit surface 4-30
 color map 6-31
 contour plot 6-31
 iso- interpretation 7-90
 normal vector 6-28
 save ray data 5-55
 simulation 5-56
 simulation mode 5-56
 smoothing 6-30
 up vector 6-28

CEC
 defined 2-27

CIE
 irradiance map display 6-9, 6-22

circular grid 5-8

class 4-38

Coating DLL Directory 2-58

Code V 2-47

coincident surfaces 6-51

color
 apply 4-19
 background 2-58
 object 2-59, 4-19
 property 4-19
 surface 2-59, 4-19

Complex Index 7-14

Compound Elliptical Concentrator 2-27

Compound Parabolic Concentrator 2-27

compound trough
 reflector 2-30

cone
 elliptical 2-4
 insert 2-4

Conic 2-12

conic 2-10
 reflector 2-24

conical
 RepTile 3-56

conical angle
 baffle vane 2-34

Conrady
 interpolation formula 7-7

Contour Levels
 irradiance option 6-13, 6-24

contour plot

irradiance option 6-10, 6-23

contours
 candela plots 6-31

Contrast 2-67, 6-14, 6-19, 6-25

copy
 rotate 2-41
 while moving objects 2-38, 2-39
 while scaling objects 2-42

CPC
 defined 2-27
 optimal 2-28
 using 2-27

create
 baffle vane 2-33
 blackbody source 4-18
 block 2-3
 boolean 2-35
 cone 2-4
 cylinder 2-3
 diffracting aperture 9-23
 Fresnel lens 2-22
 gradient index property 3-17, 3-20
 lens 2-10
 material property 3-6
 mirror 2-36
 mueller matrix 4-36
 polarizing element 4-33
 reflector 2-24
 source file 5-22
 sphere 2-5
 surface property 3-29
 torus 2-5
 tube 2-33

cross grid 5-8, 5-11

crude Monte Carlo 7-1

cube-corner
 RepTile 3-74

curvature
 lens 2-9

customize
 candela options 6-31

Cylinder 2-15

cylinder
 cone 2-4
 elliptical 2-4
 insert 2-3

D

database
 bulk scatter 3-9
 gradient index 3-17, 3-20
 material properties 3-5, 4-4, 4-8
 stacks 3-44
 surface properties 4-11
 utilities 6-65

DDE server 8-10

dialog boxes
 expression evaluator 1-15

diffraction
 aperture 4-32
 applying 4-33
 edge 4-32
 Fraunhofer 9-22

- raytrace option 5-44
- diffraction grating
 - example 9-46
- DIN 5036 4-1
- direction arrows 2-59
- Direction-Sensitive
 - Surface Property 3-28
- display
 - Importance Targets 2-55
 - RepTile 2-54
 - voxel 2-55
- display all 2-54
 - on file open 2-61
- display object 2-53
- display object WCS 2-54
- dithered grid 5-5, 5-8, 5-10
- DLL
 - bulk scatter 3-12
 - scatter 7-28
 - surface 7-28
 - surface property 3-26
- drawing time
 - ray 2-60
- DXF
 - Export Reptile 4-43

E

- edge
 - diffraction 4-32
- edit
 - lens element 2-11
 - material property 3-7
 - prescription 4-19
- editor
 - bulk scattering 3-10
 - surface property 4-11
- ellipsoid
 - lens surface 2-13
 - RepTile 3-58
- elliptical
 - cone 2-4
 - cylinder 2-4
- elliptical BSDF 7-21
 - example 9-43
- emissivity
 - surface source 4-17
- Ensquared Flux 6-15
 - irradiance 6-15
- Euler angles
 - defined 2-1
 - grid raytrace 5-15
- Eulumdat
 - candela option 6-35
- exit surface 4-30
 - reverse ray trace 5-37
 - simulation mode 5-54
- exit surface data 5-48
 - simulation mode 5-56
- export
 - gradient index 3-19, 3-22
 - IGES 2-45
 - material property 3-7
 - property data 3-84

- SAT file 2-45
- STEP 2-45
 - surface property 3-30
- Export Rays 6-61
- Export Reptile 4-43
- expression evaluator 1-15
- extinction coefficient 7-14
- eye
 - pan 2-52
 - set view 2-50

F

- F11 3-84
- F12 3-84
- facet
 - Fresnel Lens 2-23
- facetted reflector 2-31
- file
 - text format 2-58
- File Sources 5-1, 5-22
- Fluorescence 3-12
 - Ray Sorting 6-60
- Fluorescence Property Generator 3-14
- Fluorescence Ray Trace 3-15
- flux
 - absorbed 3-8
 - bulk scattering 7-61
 - grid raytrace 5-14
 - importance sampling 7-3
 - report 6-63
 - setting thresholds 5-44
 - surface source 4-12
- Flux-based ray colors 6-2
- foot-candles
 - irradiance option 6-11
- Forbes 2-13
- formula evaluation
 - See expression evaluator
- Fresnel Coefficients
 - calculation 7-26
 - surface property 3-26
- Fresnel lens 2-22
 - aspheric 2-24
 - equation 2-23
 - RepTile 3-49, 4-40
 - RepTile example 9-1

G

- Gamma 2-67, 6-14, 6-19, 6-25
- gaussian
 - grid raytrace 5-15
 - gaussian BSDF 7-24
- Gegenbauer 3-10, 7-62
- glass catalogs 3-5, 4-4
- Gradient Index 3-12
 - applying 4-9
 - export 3-19, 3-22
 - import 3-19, 3-22
 - polynomials 7-9
 - raytrace step size 5-53
- GRADIUM 3-20, 4-9
 - polynomials 7-11

- grating
 - surface property 3-24
- Graybody
 - surface source 4-12
- grid boundary 5-5, 5-7
- grid raytrace 5-1
- Grid Setup 5-5, 5-15
- Grid Source 5-3
- GUERAP 7-1

H

- Handbook of Optics
 - interpolation formula 7-8
- Harvey-Shack
 - BDSF model 7-16
- Height
 - candela option 6-33
- Heney-Greenstein 3-9, 7-61
 - and Gegenbauer 7-62
- Herzberger
 - interpolation formula 7-7
- Hidden Line 2-50
- hide
 - object 2-53
- hip-roof
 - RepTile 3-59
- hyperboloid
 - lens surface 2-13

I

- IES/LDT Plots 6-77
- IESNA
 - candela option 6-35
- IGES 2-46
 - export 2-45
 - import 2-45
- imaginary index 3-8
- import
 - gradient index 3-20, 3-22
 - IGES 2-45
 - lens design 2-47
 - material property 3-8
 - property data 3-83
 - SAT file 2-45
 - setting model units for geometry 2-61
 - STEP 2-45
 - surface property 3-30
- import data 2-1
- importance sampling 7-1, 9-26
 - add 4-22
 - apply 4-20
 - automatically defining 4-26
 - bulk scatter 4-7
 - bulk scattering 7-62
 - detector target 7-6
 - diffraction 9-26
 - manually defining 4-21
 - random rays 7-3
 - reference 7-2
 - surface source 4-17, 5-22
 - surface sources 5-22
 - when it is used 7-2

- importance target
 - display 2-55
- incident flux
 - flux report 6-63
 - importance sampling 7-3
- incident ray table 5-23, 6-49
 - display format 6-50
 - display rays 6-54
- index of refraction 7-6
 - complex 7-14
 - material property 3-5
- Insert Lens
 - lens example 9-41
- Insert Tube
 - Tapered 2-33
- inserting files 2-49
- interpolation
 - material properties 3-5
 - surface property 3-23
- interpolation formulas
 - material property 7-7
- intersect
 - Boolean 2-36
 - importance sampling 7-4
- Inventor 2-46
- Irradiance 9-26
 - surface source 4-12
- irradiance
 - adding maps 6-74
 - BSDF 7-15
 - color map 6-12, 6-24
 - viewer 6-72
- irradiance maps
 - from saved ray data 6-65
 - options 6-7
- iso view 2-52
- ISO X-Toric 2-16
- ISO Y-Toric 2-16

K

- knife edge
 - baffle vane 2-34

L

- Lambertian
 - BSDF 7-18
- lens
 - insert 2-10
- lens design
 - Euler angles 2-1
 - import 2-1, 2-47
 - merging 2-49
- lens element
 - defined 2-9
 - modify 2-11
 - using Boolean 2-36
- Lighting Efficiency
 - example 6-9
- Lighting Toolkit 6-77
- linear systems theory
 - BSDF 7-16
- lit appearance 2-64

Logarithmic Scale
 irradiance option 6-11, 6-23
Luminance 5-38
 Display maps 6-18
luminous intensity 5-43, 6-26

M

macro 8-1, 9-31
Macro Recorder 8-2
major radius
 torus 2-4
material 1-iii
 for stacks 3-44
 selecting in editor 7-7
material catalogs 3-5
material property
 and bulk scattering 7-62
 applying 4-4
 applying birefringent 4-5
 bulk scattering 7-63
 editor 3-5
 export 3-7
 import 3-8
 intepolation formulas 7-7
 new 3-6
 reference 7-6
Max Photons To Trace 2-66
mean free path 3-10, 7-62
merging files 2-49
minor radius
 torus 2-4
mirror
 from lens insert 2-9
model
 ABg 7-18
 BSDf 7-16
 material property 7-6
 scale 2-62
model units
 defined 2-1
 measurement dialog 6-78
 setting default 2-61
model window
 pan 2-52
 start up size 2-57
 zooming 2-51
Modify
 primitive solid 2-2
Monte Carlo 7-1
 analysis 4-20
move
 absolute 2-38
 copy 2-39
 copy example 9-38
 objects 2-37
 relative 2-38
 source file 5-25
 zoom 2-51
MOXTEK 3-43
Mueller matrix 4-33, 5-20
 create 4-33
 reference 7-57
 table of examples 7-57

N

naming views 2-52
normal vector
 candela plots 6-26, 6-28
 grid raytrace 5-14
 irradiance maps 4-31, 6-7, 6-15
 polarization map 6-45
 raytrace grid 5-19
Notepad++ 8-2
Notes Editor 2-44

O

object
 bulk scattering 7-61, 7-62
 color 4-19
 colors 2-59
 creating arrays 2-38, 2-41
 material property 7-6
 move 2-37
 orientation 2-42
 rotate 2-37, 2-39
 scale 2-37, 2-41
 transparency 4-20
 zoom 2-51
Object Selection
 Advanced 1-12
Objects
 Solid Modelling 2-1
oblate spheroid
 lens surface 2-13
obstruction
 entering lens 2-20
 lens 2-9
Octree voxels 5-51
Odd Cosine 2-18
oml file 2-1, 6-65
OPL 6-45
OPL/Time-of-flight plot 6-45
optical path length 6-45
optimal
 importance targets 7-4
optimal CPC 2-28
Optimization 5-1, 5-58
orientation
 candela plots 6-26
 irradiance maps 6-7
 raytrace grid 5-19
OSL
 file extension 2-48
OSLO 2-47, 4-32

P

package
 dimensions 2-32
 Rim Ray reflector 2-31
pan
 model window 2-52
parabolic concentrators 2-27
paraboloid
 lens surface 2-13
parameterization

- RepTile 3-77
- Parameterized Reptile
 - Depth 4-42
- Path Sort Filter Editor 6-5
- Path Sort Filter Intercept Types 6-6
- Path Sort Table 5-48
- Path Sort Table Settings 6-4
- pause
 - raytrace 5-36
- perspective view 2-50
- Phase Function 3-10, 7-61, 7-62
- photometric units option 5-43
- Photorealistic Rendering 2-64, 5-38, 9-67
- Photorealistic Rendering Setup 2-65
- physical memory
 - raytrace 5-54
- plot
 - surface property 3-30
- Point Source Transmittance 6-9
- Polar Iso-Candela Plot 6-29, 6-31
- polarization 5-45
 - enabling 5-45
 - grid raytrace 5-20
 - maps 6-42
 - ray history 6-57
 - setup 5-7
 - surface property 3-24
- polarization state 5-7
 - set up 5-20
- polarizer
 - wire grid 3-43
- Polygon RepTile 3-72
- position
 - object 2-1
- prescription 4-18, 4-26
- primitive solid
 - entering 2-2
 - rubberband 2-8
- primitive solids
 - drawing solids 2-8
- prism
 - RepTile 3-61
- Pro/E 2-46
- profiles
 - irradiance option 6-11
- property
 - color 4-19
 - report 6-64
- property database
 - import tool 3-83
 - material 3-5
 - material format 7-7
 - material property 7-6
 - surface 3-23
- property editors
 - introduction 3-1
- Pyramid Geometry 3-74

Q

- Q-type asphere (Qbfs) 2-13
- Q-type asphere (Qcon) 2-13
- QWOT 3-45

R

- Radial Spline 2-19
- Radiance 5-38
 - Display Maps 6-18
- radiance
 - BSDF 7-15
 - surface source 4-18
- Radiant Imaging 5-22
- radiometric units
 - option 5-42
- radius
 - lens 2-9
- random grid 5-3, 5-5
- random rays
 - importance sampling 7-3
 - option 5-42, 5-44
- ray
 - direction arrows 2-59
 - drawing time out 2-60
 - file 6-64
 - sorting 6-58
- ray histories 6-55
 - display format 6-57
- ray node
 - incident ray table 6-52
 - ray history 6-57
- Ray Sorting
 - Fluorescence 6-60
- ray splitting 5-43, 7-1
- Ray Trace
 - Fluorescence 3-15
- raytrace
 - grid 5-3
 - source 5-22
- Raytrace Mode 2-63
- Raytrace Options 5-5, 5-41
- raytrace report 6-63
- rectangular concentrator
 - reflector 2-31
- rectangular grid 5-8
- Rectangular Iso-Candela 6-26, 6-32
- reflection
 - surface property 3-23, 7-15
- reflective scattering 7-19
- reflector
 - 3D compound 2-27
 - compound trough 2-30
 - conic 2-24
 - faceted 2-31
 - insert 2-24
 - package 2-31
 - rectangular concentrator 2-31
 - trough 2-29
 - types 2-24
- relative ground angle
 - baffle vane 2-34
- render 2-50
- Rendering Quality 2-66
- report
 - flux 6-63
 - property 6-64
- reports 6-63
- RepTile
 - apply 4-40

- display 2-54
 - texture file format 7-111
 - texture, applying 4-46
 - texture, defining 3-74
 - Reptile
 - Depth for Parameterized 4-42
 - Export 4-43
 - RepTile Surfaces
 - overview 3-49
 - Reset Defaults 1-11, 2-63
 - restore
 - ray data from file 5-55
 - resume
 - raytrace 5-36
 - retroreflection
 - surface property 3-24
 - reverse ray tracing 5-36
 - example 9-51
 - revolve 2-42, 2-43
 - example 9-36
 - surface 2-43
 - Rim Ray
 - reflector 2-31
 - ring width
 - Fresnel 2-22
 - rotate
 - block 2-3
 - cone or cylinder 2-4
 - copy 2-41
 - copy example 9-38
 - cylinder 2-4
 - object 2-37, 2-39
 - source file 5-25
 - torus 2-5
 - rotation
 - merge 2-49
 - object 2-1
 - Rotationally symmetric asphere 2-14
 - rounded prism
 - RepTile 3-62
 - rubberband
 - selection 2-38
 - zoom 2-51
- S**
- save
 - ray data 5-55
 - Save Data to Disk 5-48
 - SAVE-DATA 3-83
 - scale
 - copy 2-42
 - model 2-62
 - object 2-37, 2-41
 - scatter DLL 3-12, 7-28
 - scattering
 - and BSDF 7-16
 - BSDF 7-15
 - bulk 7-61
 - bulk model 7-61
 - defining bulk model 7-62
 - Harvey-Shack 7-16
 - in biological tissue 7-61
 - probability function 7-6
 - simulating 7-3
 - simulating bulk 7-62
 - surface property 7-15
 - scattering direction 7-15
 - scattering distribution function 3-9, 7-15, 7-18, 7-61
 - scheme 8-1, 9-31
 - scheme editor 8-2
 - Schott
 - interpolation formula 7-7
 - Schott formula 3-6
 - SDF 3-9
 - defined 7-61
 - segmentation
 - importance sampling 4-25
 - select object
 - Advanced 1-12
 - select surface
 - Advanced 1-12
 - selecting
 - simulation options 5-56
 - selection
 - zoom 2-51
 - selection tool 2-38
 - Sellmeier
 - GRADIUM 7-12
 - interpolation formula 7-7, 7-8
 - Sellmeier formula 3-6
 - Sending Scheme commands to TracePro 8-2
 - SEQ
 - file extension 2-48
 - sequence file 2-48
 - Set Defaults 1-11
 - set view 2-50
 - silhouette 2-50
 - display accuracy 2-51
 - SIM 5-48
 - Simulation information 5-48
 - simulation mode
 - and exit surface 4-30
 - defined 5-55
 - options 5-56
 - ray display 6-1
 - selecting 5-54
 - Smoothing
 - candela option 6-30
 - smoothing
 - candela plots 6-30
 - irradiance option 6-10, 6-11, 6-23
 - Solar Emulator 6-77
 - Solid Modeling
 - Introduction 2-1
 - solid modeling
 - boolean operations 2-35
 - sorting rays 6-58
 - Source
 - Grid 5-3
 - source file 5-22, 5-23
 - source raytrace 5-22
 - Source-based ray colors 6-3
 - Sources
 - File 5-1, 5-22, 5-26
 - Grid 5-1
 - Surface 5-1
 - Sources Editor 5-34

- specular rays
 - importance sampling 7-2
 - specular reflectance 7-26
 - surface property 3-23
 - specular transmittance
 - surface property 3-24
 - sphere
 - insert 2-5
 - spherical
 - RepTile 3-57
 - Stack
 - surface property 3-24
 - starting ray 5-14
 - in Analysis Mode 5-54
 - STEP 2-46
 - export 2-45
 - import 2-45
 - Stokes vector 4-33, 5-7, 5-20, 5-45
 - defined 5-20
 - incident ray table 6-52
 - polarization map data 6-45, 6-48
 - polarization option 5-45
 - ray history 6-57
 - reference 7-57
 - table of examples 7-57
 - unpolarized 5-21
 - stray light 4-21, 6-9, 7-2, 7-3
 - diffraction 4-32
 - importance targets 7-4
 - subtract
 - using 2-36
 - Superconic 2-18
 - surface
 - color 4-19
 - colors 2-59
 - revolve 2-43
 - sweep 2-43
 - Surface Property
 - Asymmetric Table BSDF 3-33, 3-39
 - direction-sensitive 3-28
 - surface property 3-23, 4-11
 - anisotropic example 9-41
 - BRRDF 3-24
 - create 3-29
 - database 3-23, 4-11
 - DLL 3-26, 7-28
 - editing 3-29
 - import 3-30
 - lens 2-20
 - name 3-23
 - plotting 3-30
 - reference 7-15
 - RepTile 4-41
 - retroreflector 3-24
 - solve for 3-27
 - stack editor 3-44
 - surface property editor 3-23
 - Surface Selection
 - Advanced 1-12
 - surface source
 - applying 4-12
 - blackbody 4-18
 - spreadsheet 5-34
 - Surface Source Property 4-12
 - Surface Source Property Generator 3-20
 - Surface Sources 5-1
 - sweep 2-42
 - example 9-33
 - Symmetric cone 2-17
 - Symmetry
 - candela plots 6-29
 - irradiance option 6-11
 - system tree
 - for boolean operations 2-36
 - location 2-60
- ## T
- table BSDF 3-33
 - Table BSDF Data 7-98
 - target
 - number of importance 4-24
 - target position 2-50
 - pan 2-52
 - target, importance
 - add 4-22
 - automatic 4-26
 - detector 7-6
 - target, view
 - pan 2-52
 - set view 2-50
 - temperature
 - default 4-38
 - material 3-5
 - property 4-36
 - stack 3-44
 - surface property 3-23
 - temperature distribution
 - property 4-53
 - texture
 - applying 4-46
 - defining 3-74
 - file format 7-111
 - Texture Optimizer 5-58
 - Texture Optimizer II 5-58
 - thickness
 - baffle vane 2-34
 - bulk absorption 3-8
 - center for lens 2-10
 - physical 3-44
 - reflector 2-24
 - stack 3-44
 - tube 2-33
 - Thin Films
 - editing 3-44
 - surface property 3-26
 - thresholds
 - setting 5-46
 - setting flux 5-44
 - TIS 7-19
 - Torus 2-15
 - torus
 - defined 2-4
 - insert 2-5
 - Torus RepTile 3-70
 - Total Integrated Scatter 7-18, 7-19
 - TracePro
 - Overview 1-1

tracing a grid of rays 5-3
translation
 lens data 2-47
 merge 2-49
transmission
 ray splitting 5-43
 surface property 7-15
transmissive scattering 7-1, 7-19
transparency
 object 4-20
trough
 reflector 2-29
True color options 6-14, 6-19, 6-25
Tube
 Tapered 2-33
tube
 insert 2-33

U

uniform
 grid raytrace 5-14, 5-15
 source 4-17
units
 absorption 3-5
 absorption coefficient 3-8, 7-7
 BSDF 7-16
 candela 6-26
 default rotation 2-39
 model 2-38
 photometric option 5-43
 radiance 7-16
 radiometric option 5-42
 scattering distribution function 7-61
 setting model units 2-62
 temperature 4-38
up vector
 candela plots 6-26, 6-28
 grid raytrace 5-14
 irradiance maps 4-31, 6-7, 6-15
 polarization map 6-45
 raytrace grid 5-19
 set view 2-50
Update Property Database 3-83
User DLL 3-11

V

variance reduction 7-1
view
 Importance Target 2-55
 naming 2-52
 RepTile 2-54
 voxel 2-55
Volume Flux Viewer 6-68
voxel 5-50
 display 2-55

W

Wavelength-based ray colors 6-3
wavelengths
 material properties 3-5
 material property 7-7
 surface properties 3-23
wheel mouse
 zoom 2-51
Width
 candela option 6-33
wire grid polarizers 3-43
wireframe 2-50
Working Coordinate System
 defined 2-1

X

XY view 2-52
XZ view 2-52

Y

YZ view 2-52

Z

ZEMAX 2-47
ZMX
 file extension 2-48
zoom
 preferences 2-61